

[54] HOUSING FOR BALL PITCHING MACHINE

[75] Inventor: Paul S. Giovagnoli, Kansas City, Mo.

[73] Assignee: Master Pitching Machine, Inc., Kansas City, Mo.

[\*\*] Term: 14 Years

[21] Appl. No.: 439,923

[22] Filed: Nov. 8, 1982

[52] U.S. Cl. .... D21/210

[58] Field of Search ..... D21/2; 273/26 D; D21/1, D21/7, 191, 199, 5, 203, 210

[56] References Cited

U.S. PATENT DOCUMENTS

|            |         |                |       |            |
|------------|---------|----------------|-------|------------|
| D. 189,358 | 11/1960 | Giovagnoli     | ..... | D21/210    |
| D. 191,365 | 9/1961  | Fleishman      | ..... | D21/210    |
| D. 251,029 | 2/1979  | Haller et al.  | ..... | D21/210    |
| D. 260,024 | 7/1981  | Saito et al.   | ..... | D21/210    |
| 3,779,227  | 12/1973 | Scott          | ..... | 273/26 D X |
| 4,269,162  | 5/1981  | Abraham et al. | ..... | 273/26 D X |

Primary Examiner—Winifred E. Herrmann

Assistant Examiner—Theodore M. Shooman  
Attorney, Agent, or Firm—Schmidt, Johnson, Hovey & Williams

[57] CLAIM

The ornamental design for the housing for ball pitching machine, as shown and described.

DESCRIPTION

FIG. 1 is a side elevational view of a housing for ball pitching machine showing my new design; FIG. 2 is an end elevational view thereof; FIG. 3 is a side elevational view thereof, viewing from the side opposite to that depicted in FIG. 1; FIG. 4 is an end elevational view thereof, viewing the end opposite to that depicted in FIG. 2; FIG. 5 is a top plan view thereof; FIG. 6 is a top plan view thereof, with the housing cover in partially shifted condition; FIG. 7 is a bottom plan view thereof, with the cover member in a fully recessed position; and FIG. 8 is a side elevational view similar to FIG. 1, but illustrates the housing cover in its fully recessed position.

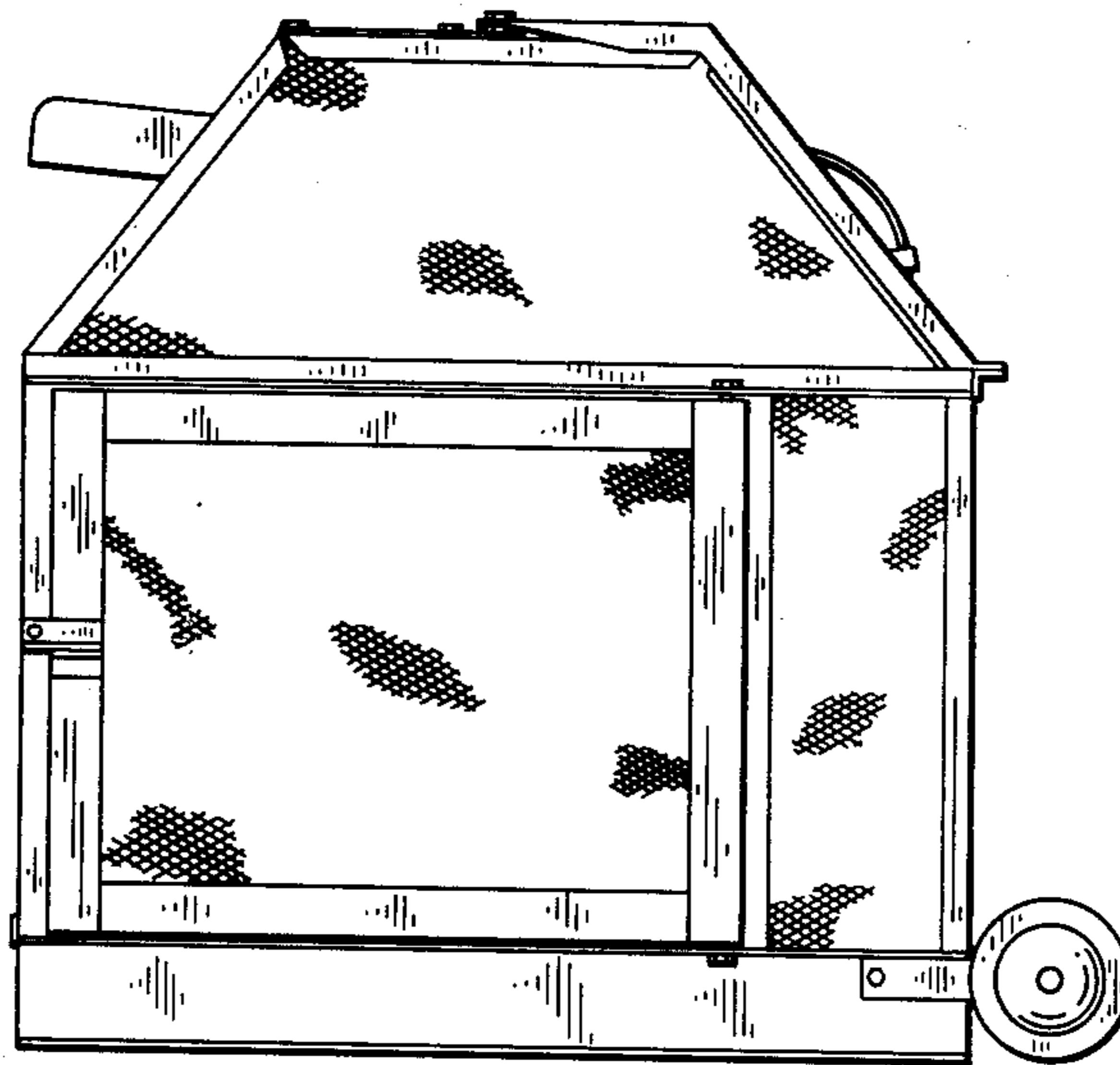

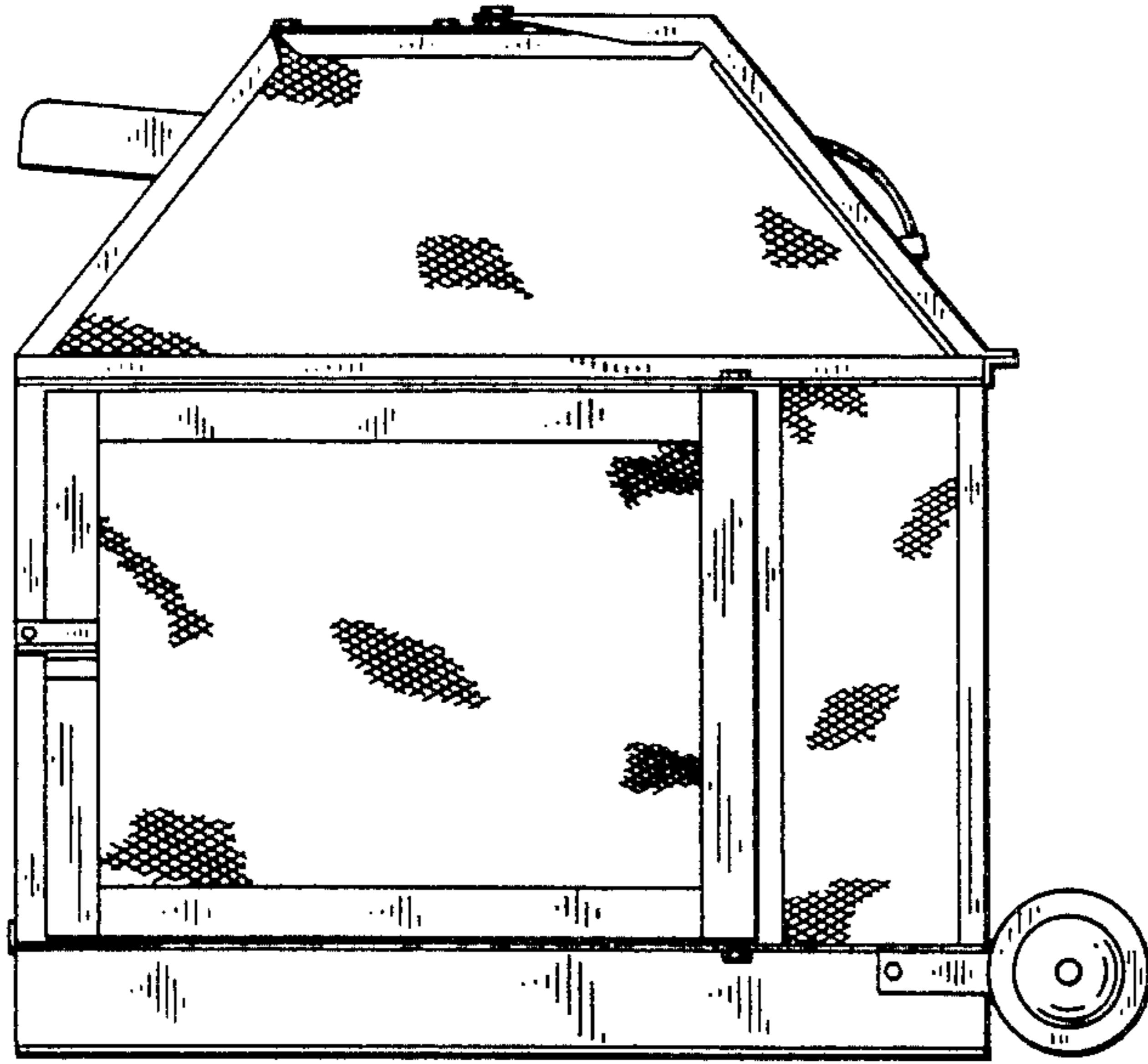

Fig. 1

Fig. 2

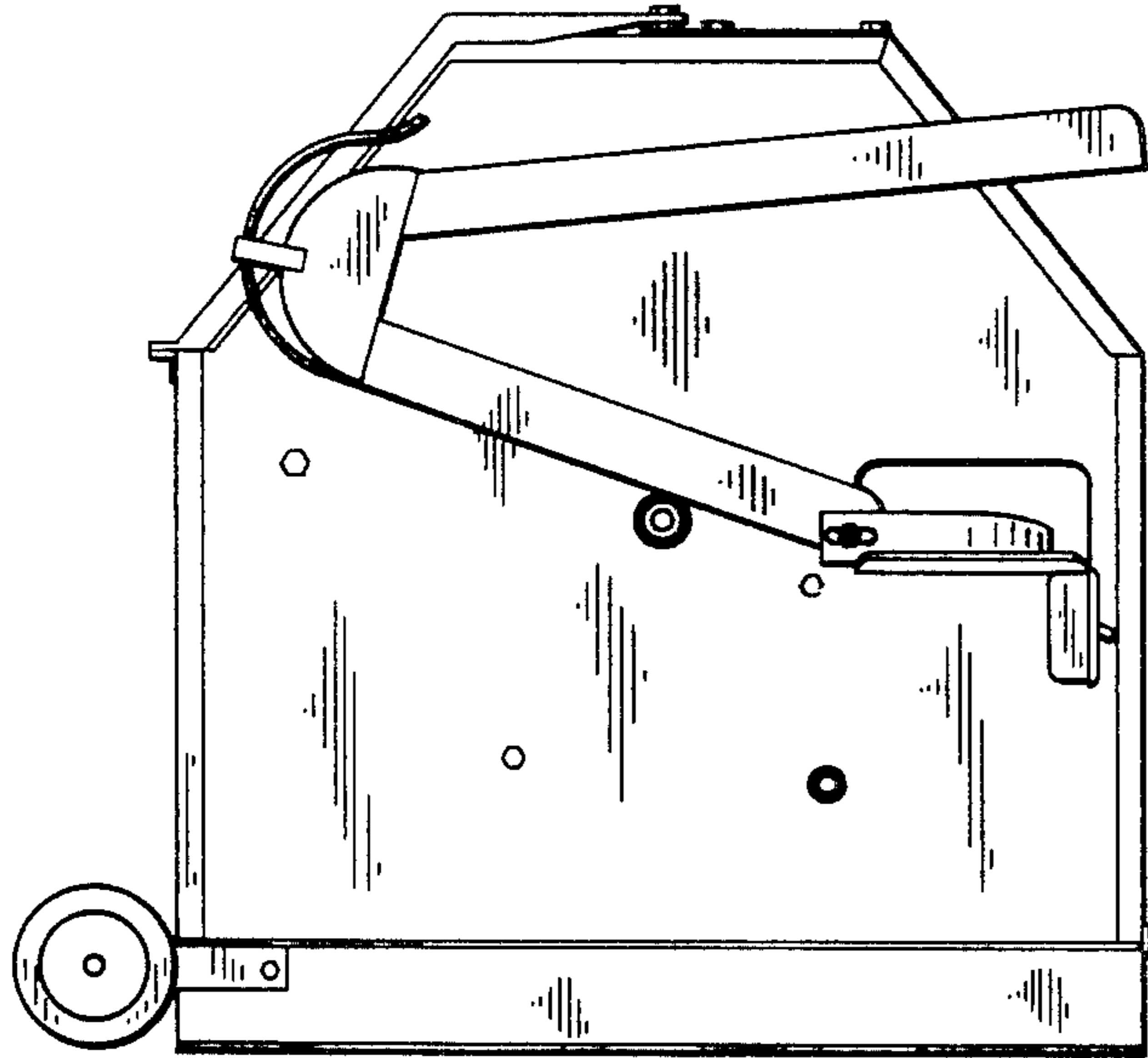
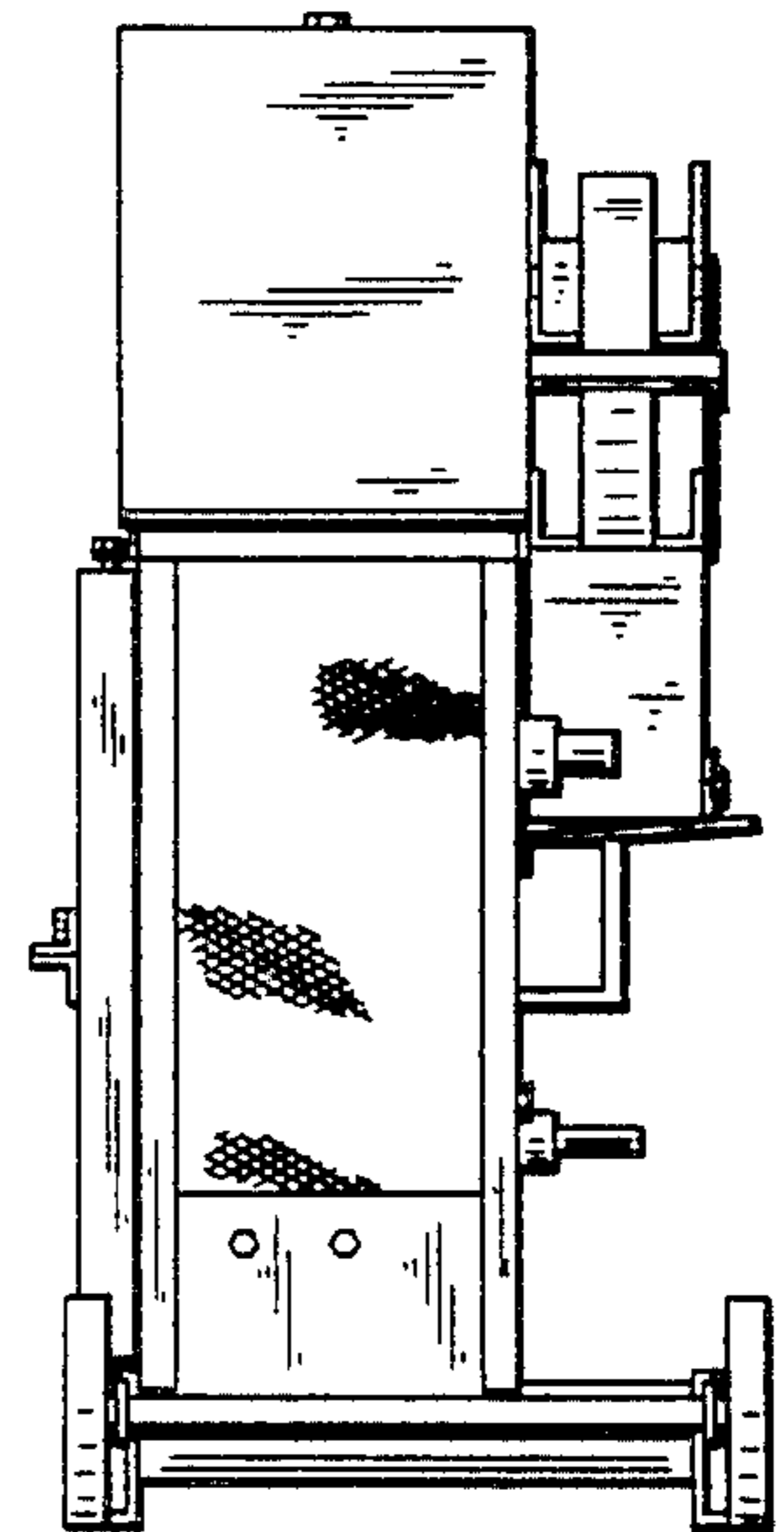
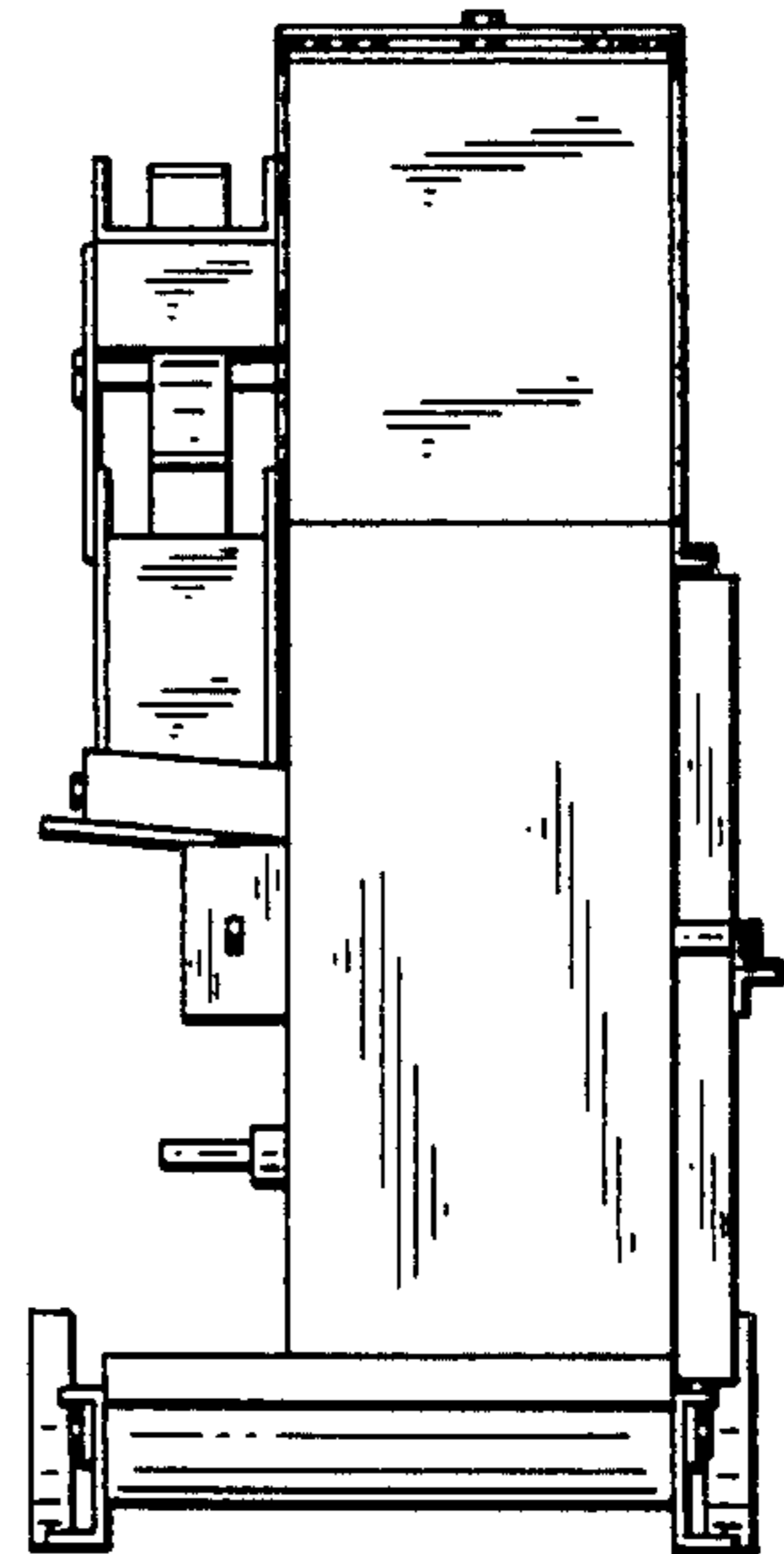
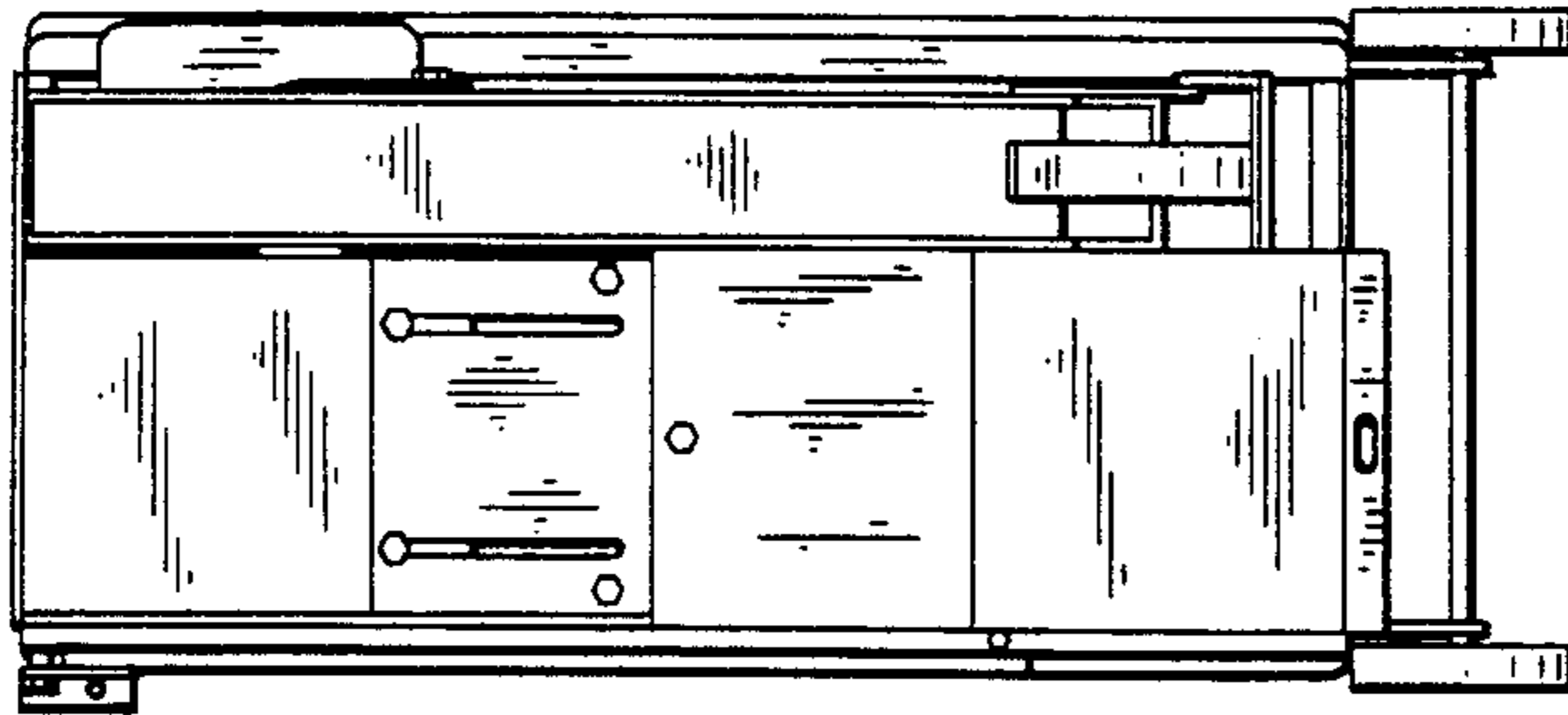

Fig. 3

Fig. 4



*Fig. 5*



*Fig. 6*

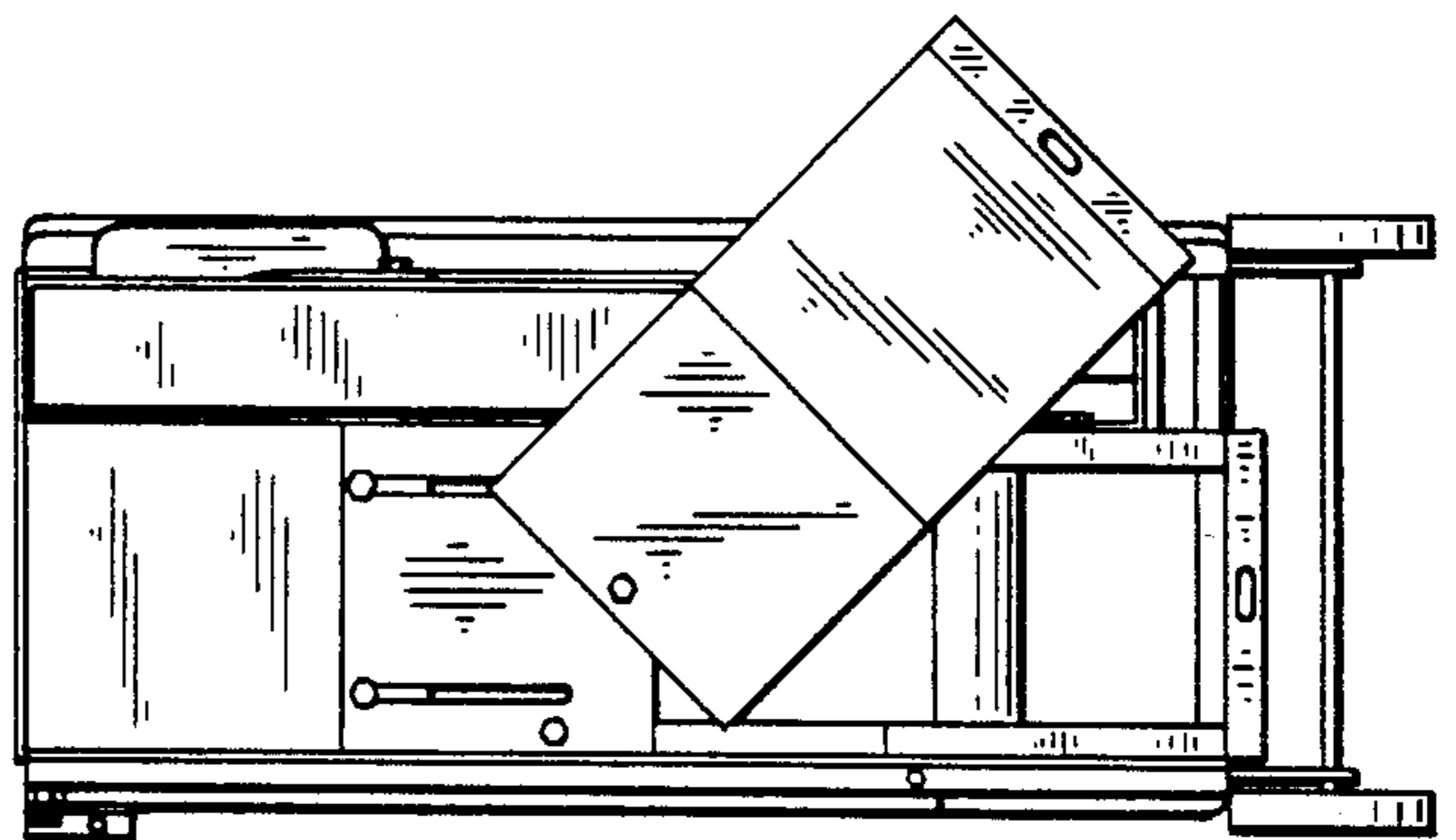

*Fig. 7*

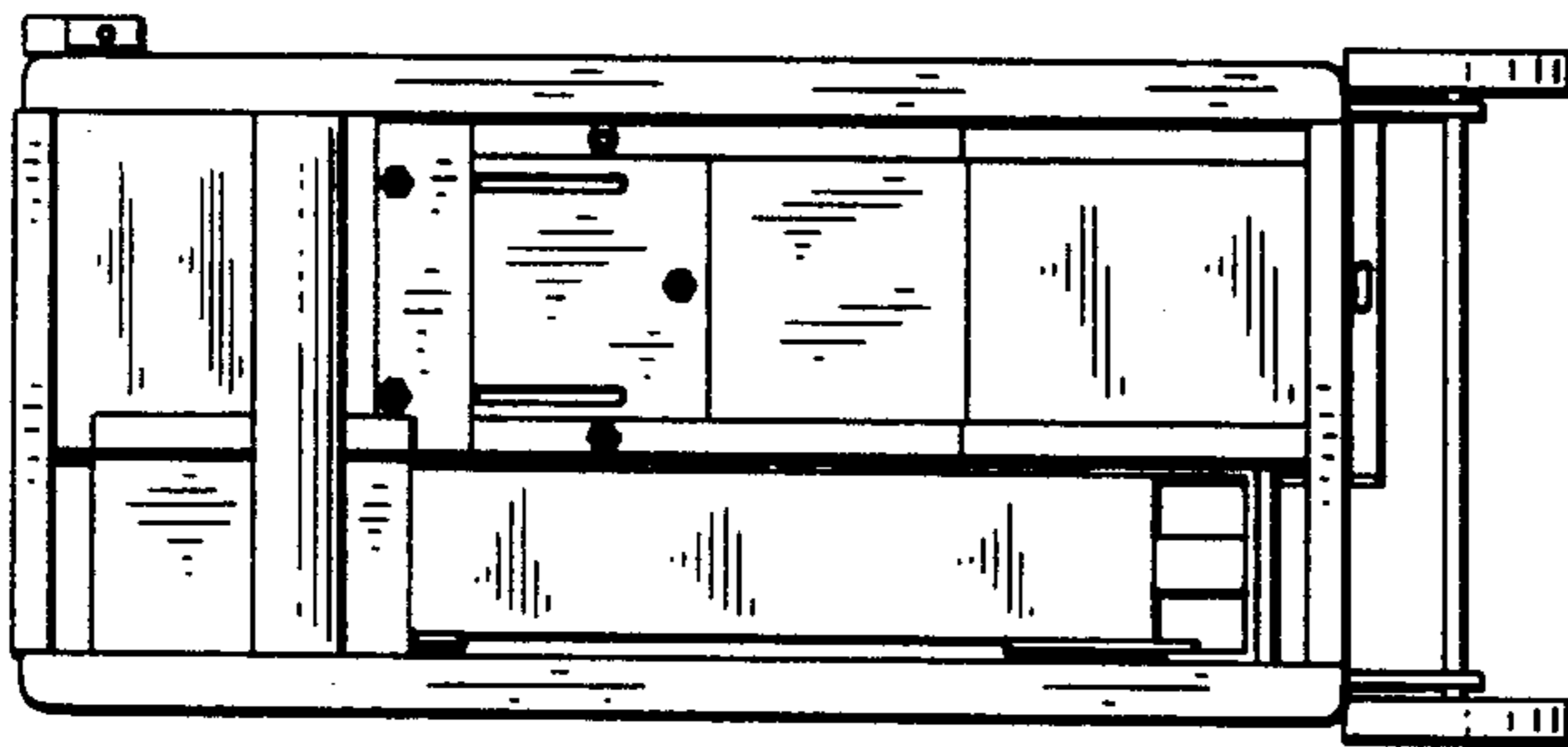

*Fig. 8*

