

[54] TRACK ROLLER CARRIAGE

[76] Inventor: Lance M. Vater, 9 Redounau Crescent, Wattle Park, South Australia, Australia, 5066

[**] Term: 14 Years

[21] Appl. No.: 360,956

[22] Filed: Mar. 23, 1982

[52] U.S. Cl. D8/377

[58] Field of Search D8/377, 373, 374, 380; 16/91, 97, 105, 106, 99, 107, 98

[56] References Cited

U.S. PATENT DOCUMENTS

D. 259,330	5/1981	Stine	D8/377
D. 266,614	10/1982	Neville	D8/377
1,713,165	5/1929	Bridge	16/91
1,931,796	10/1933	Hoffman	16/91
3,057,005	10/1962	Dishaw	D8/377
3,107,947	10/1963	Hulterstrum	16/105
3,193,870	7/1965	McNinch	16/97
3,193,871	7/1965	Foltz	16/105
3,371,372	3/1968	Banse	16/105
3,708,827	1/1973	Foltz	16/98
4,014,377	3/1977	Kochanowski	16/91

FOREIGN PATENT DOCUMENTS

1405931 9/1975 United Kingdom 16/91

OTHER PUBLICATIONS

American Builder, Jan. 1952, p. 105, Item AB128, Nylon Wheels, Holcomb & Hoke Mfg Co., Indianapolis, Ind.

Catalog III, Cannon Ball Door Hanger, by Starline Inc., Harvard, Il., Stay Rollers on p. 32.

Primary Examiner—Wallace R. Burke

Assistant Examiner—Horace B. Fay

Attorney, Agent, or Firm—Townsend and Townsend

[57] CLAIM

The ornamental design for a track roller carriage, substantially as shown and described.

DESCRIPTION

FIG. 1 is a side elevation of a track roller carriage showing my new design with the pendant bolt depicted in broken lines here and in FIGS. 2 and 5 being shown to indicate operative environmental relationship only;

FIG. 2 is an end elevation;

FIG. 3 is a top plan view;

FIG. 4 is a bottom plan view;

FIG. 5 is a top, front and side perspective view.

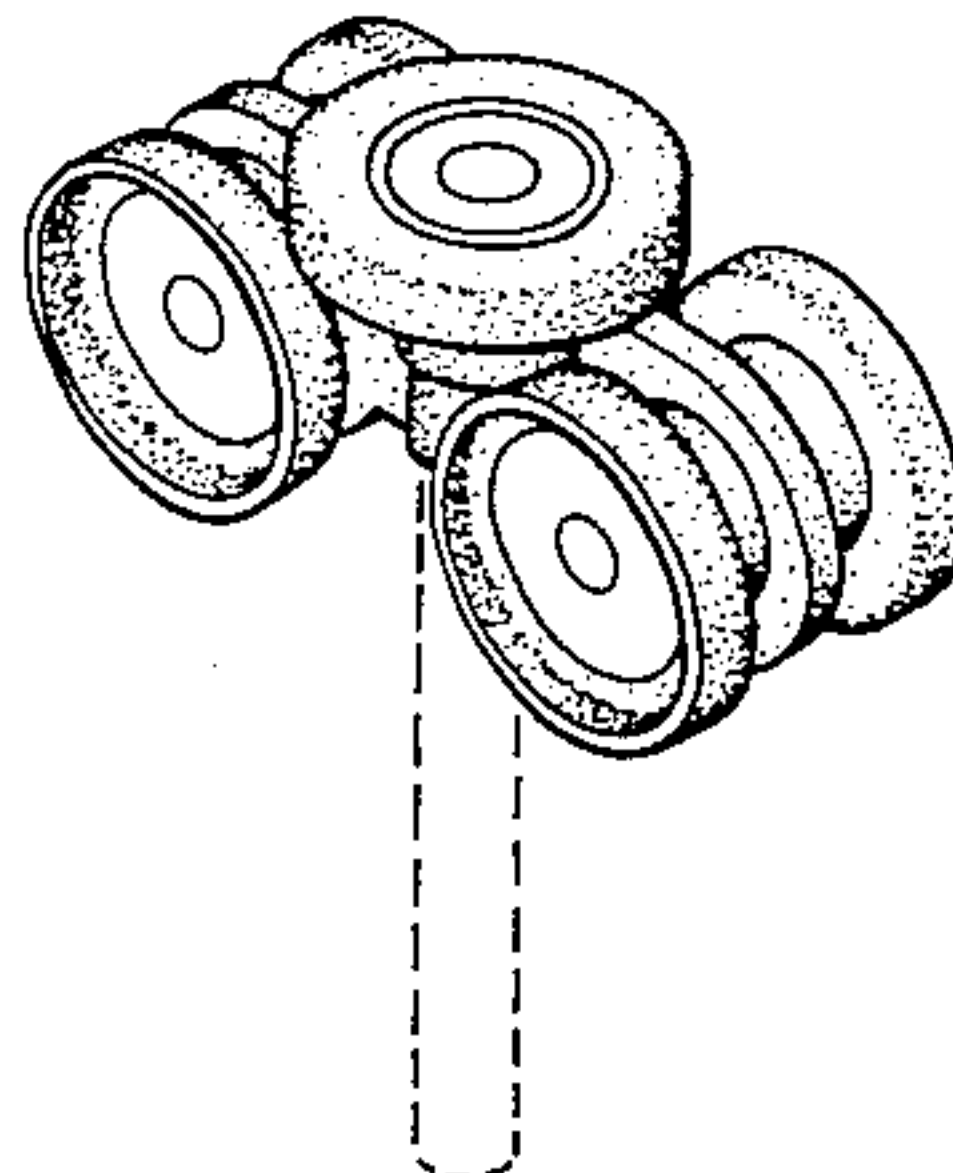
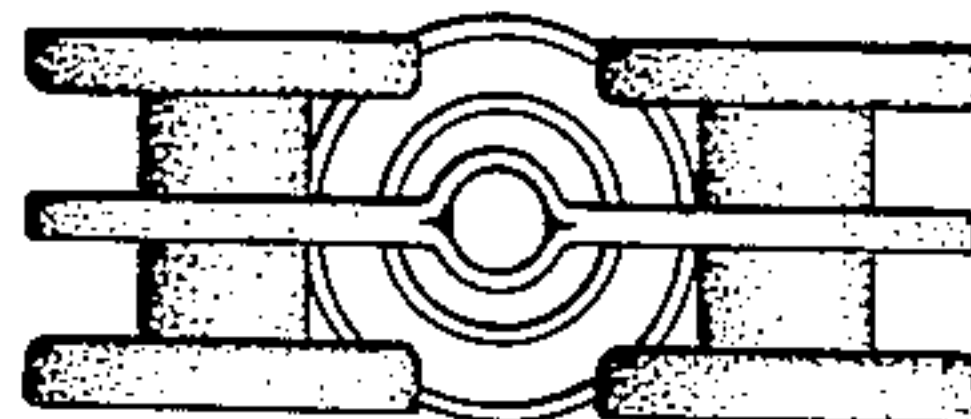

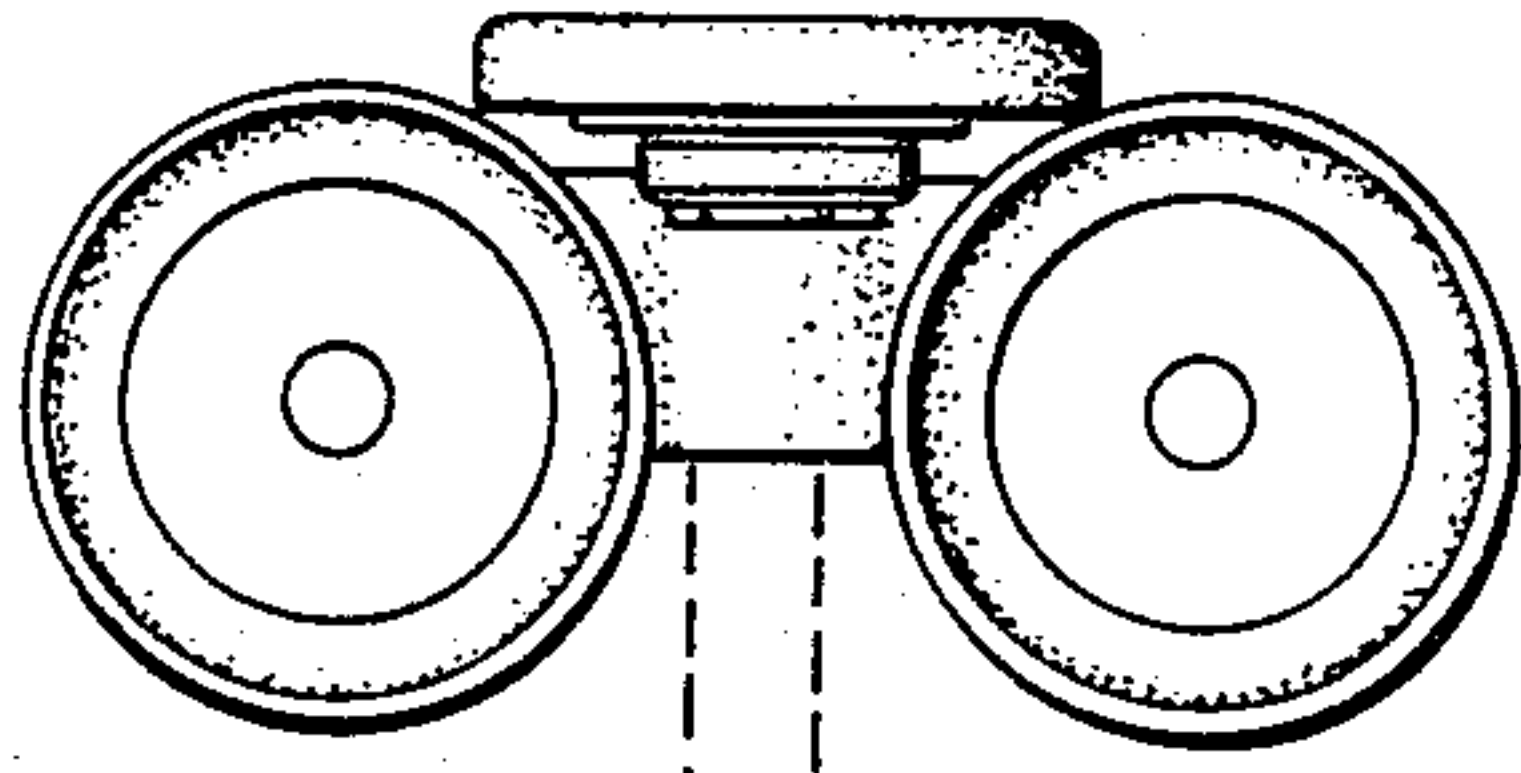

FIG. 1.

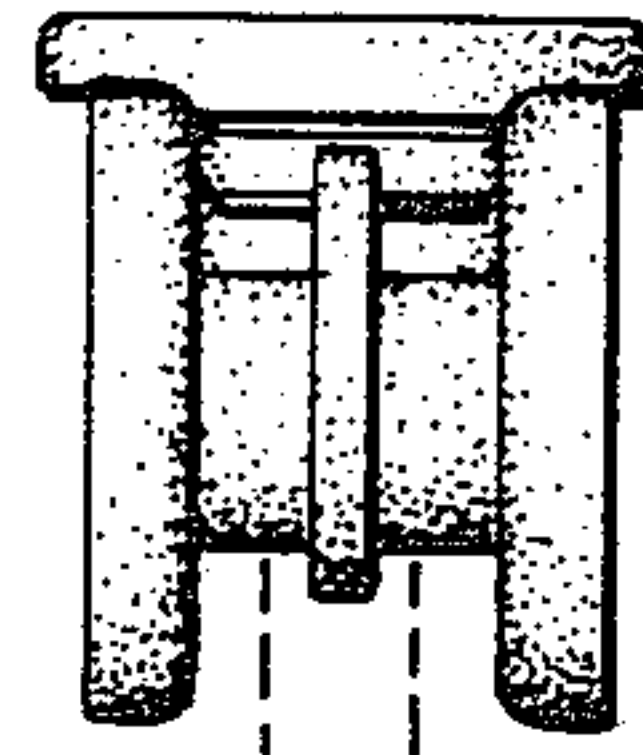

FIG. 2.

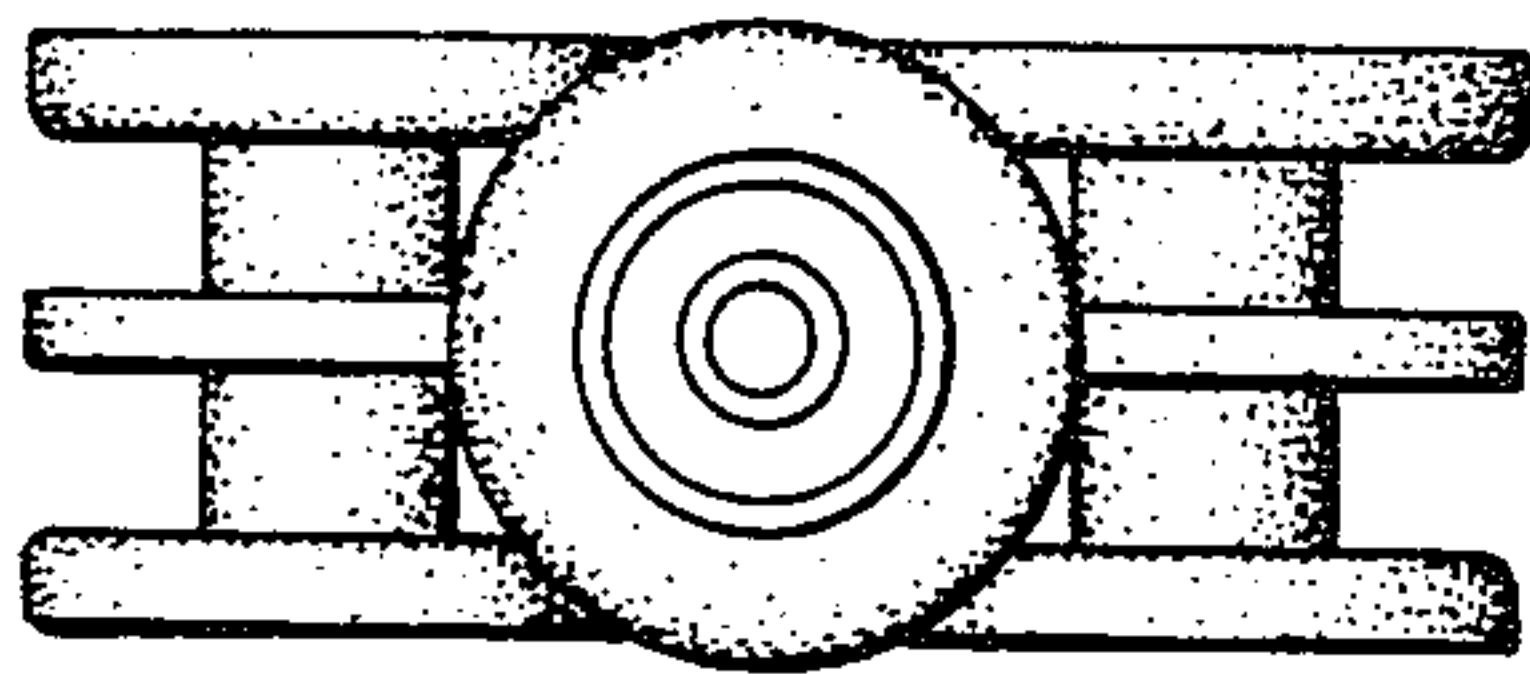

FIG. 3.

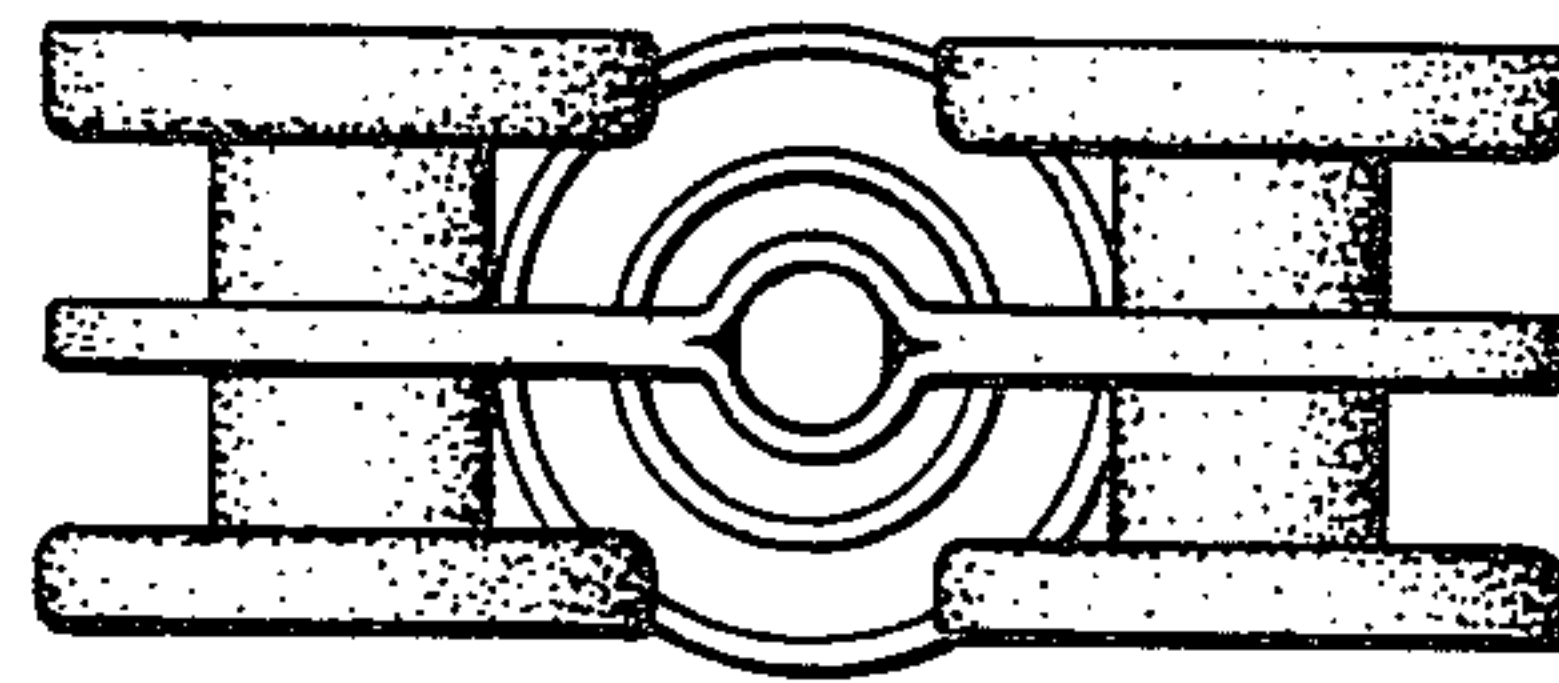

FIG. 4.

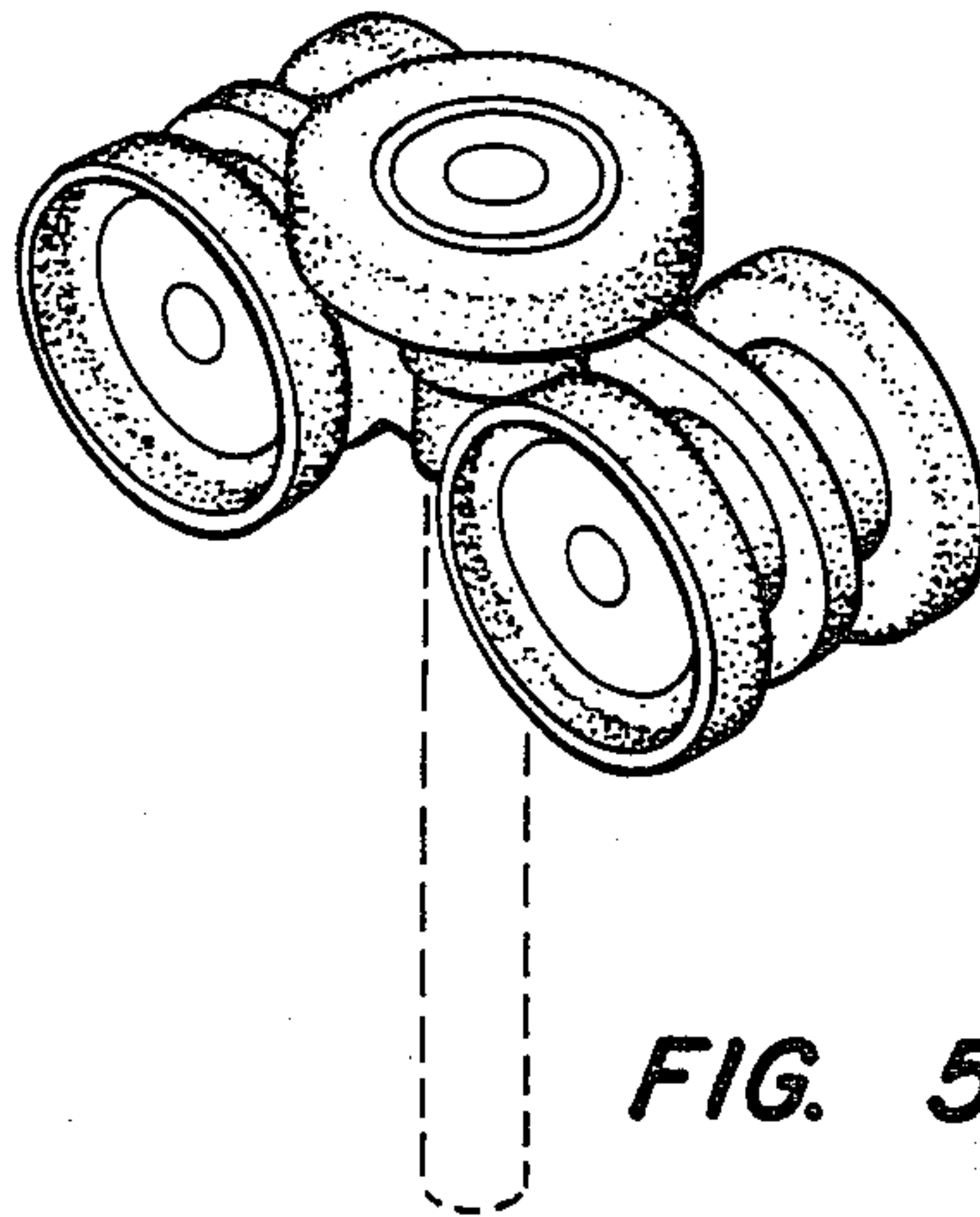

FIG. 5.