

[54] **PENDANT MEDICAL MICROFILM READER**

[75] **Inventor: Joanne Satterelli, Jackson, Mich.**

[73] **Assignee: National Child Safety Council,
Jackson, Mich.**

[**] **Term: 14 Years**

[21] **Appl. No.: 503,714**

[22] **Filed: Jun. 13, 1983**

[52] **U.S. Cl. D11/2; D7/9;
D7/14; D9/337; D11/80; D16/15**

[58] **Field of Search D11/1, 2, 6, 7, 40,
D11/43, 45, 75, 76, 79, 80, 85; 63/1 R-2, 18-21,
23; D9/337, 430; D7/9, 14; D16/15, 17;
40/363; 350/239**

[56]

References Cited

U.S. PATENT DOCUMENTS

D. 46,646 11/1914 Whipple D7/14
D. 247,601 3/1978 Schreckengost D7/9
2,630,642 3/1953 Mast et al. 350/239 X
4,249,330 2/1981 Chioffe 40/363

Primary Examiner—Louis S. Zarfes

Attorney, Agent, or Firm—Gilbert L. Wells

[57]

CLAIM

The ornamental design for a pendant medical microfilm reader, as shown and described.

DESCRIPTION

FIG. 1 is a top front perspective of a pendant medical microfilm reader showing my new design; FIG. 2 is a front elevational view of FIG. 1; FIG. 3 is a rear elevational view of FIG. 1; FIG. 4 is a left side elevational view of FIG. 1; FIG. 5 is a top plan view of FIG. 1; and FIG. 6 is a bottom plan view of FIG. 1.

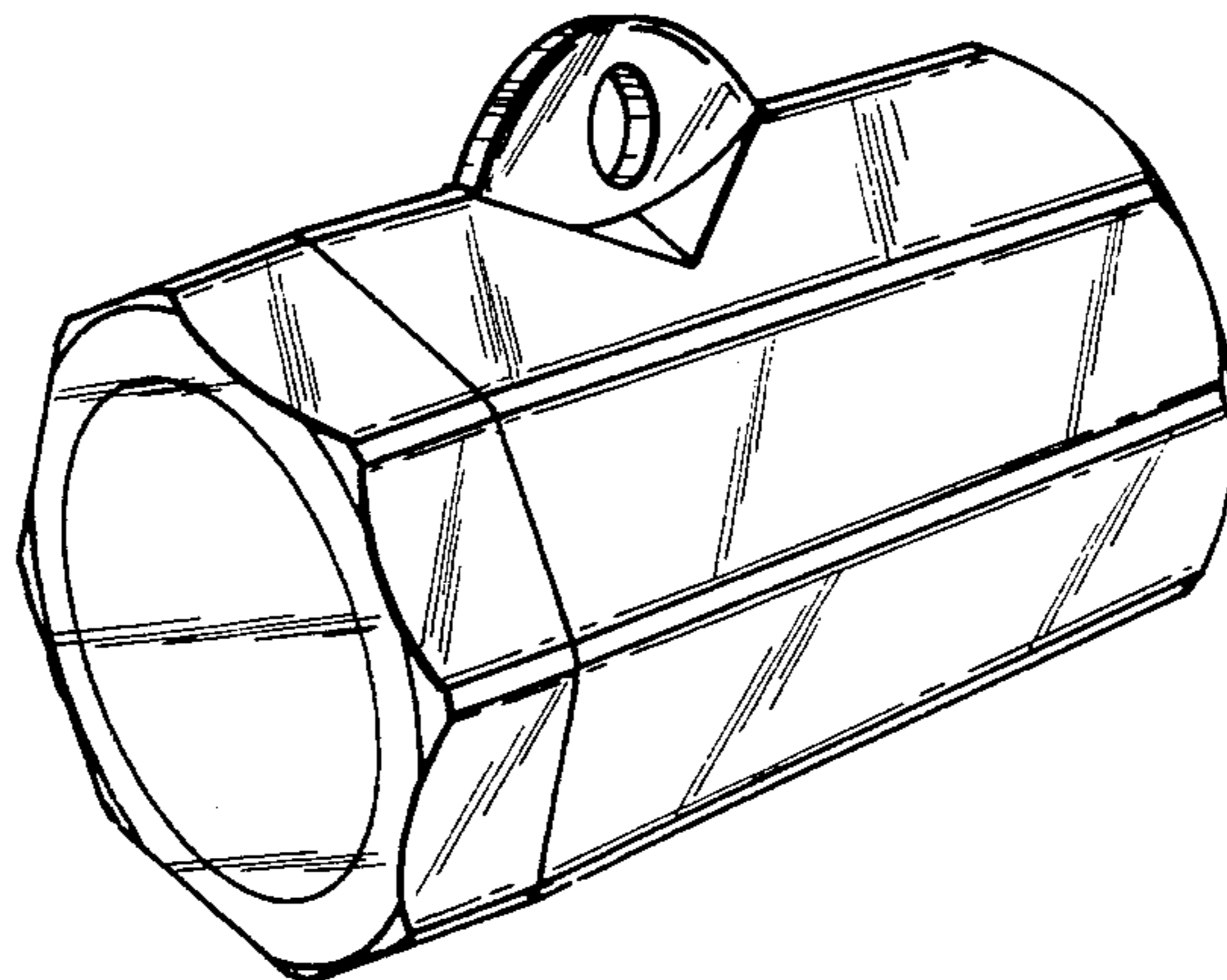

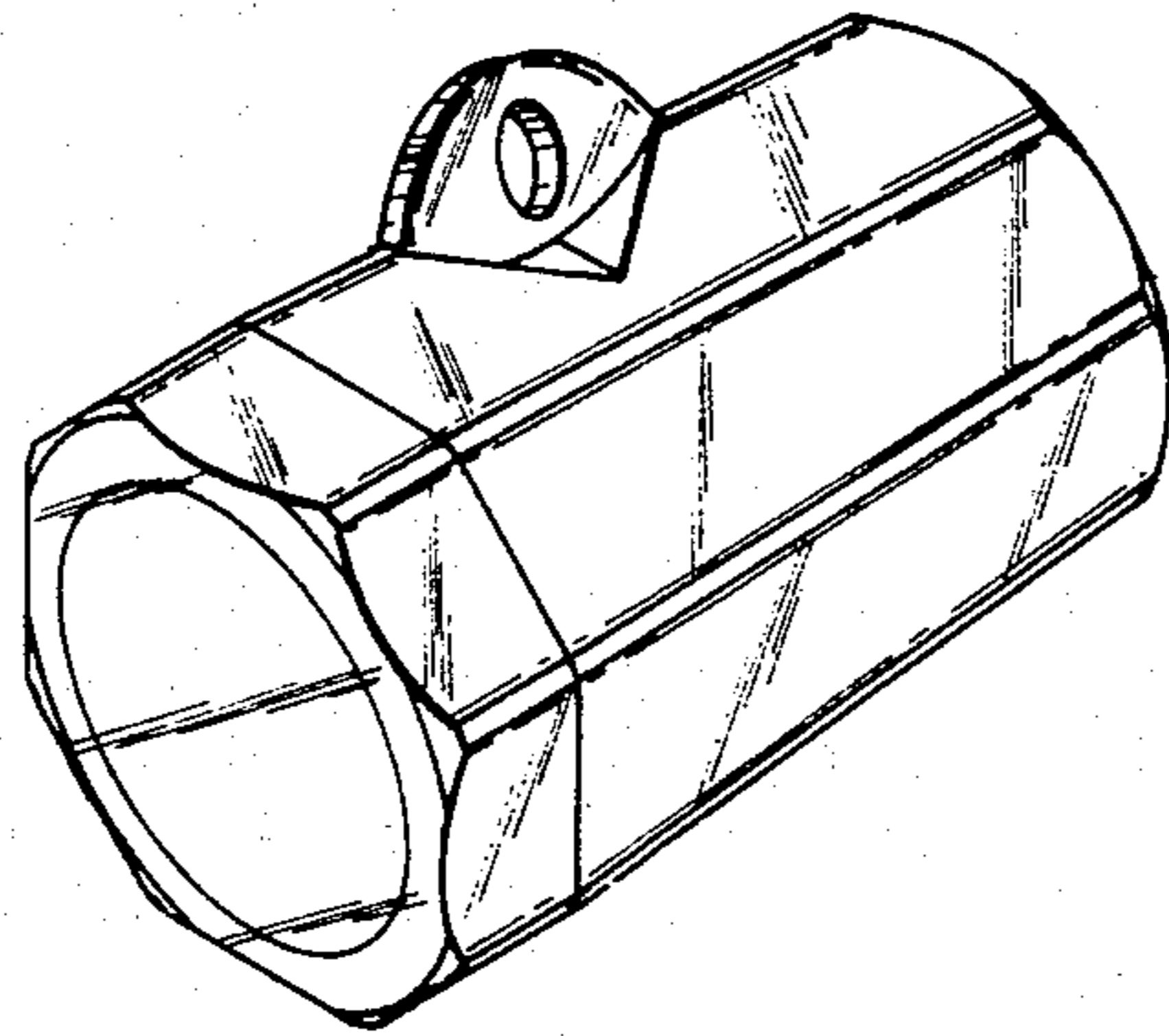

FIG. 1

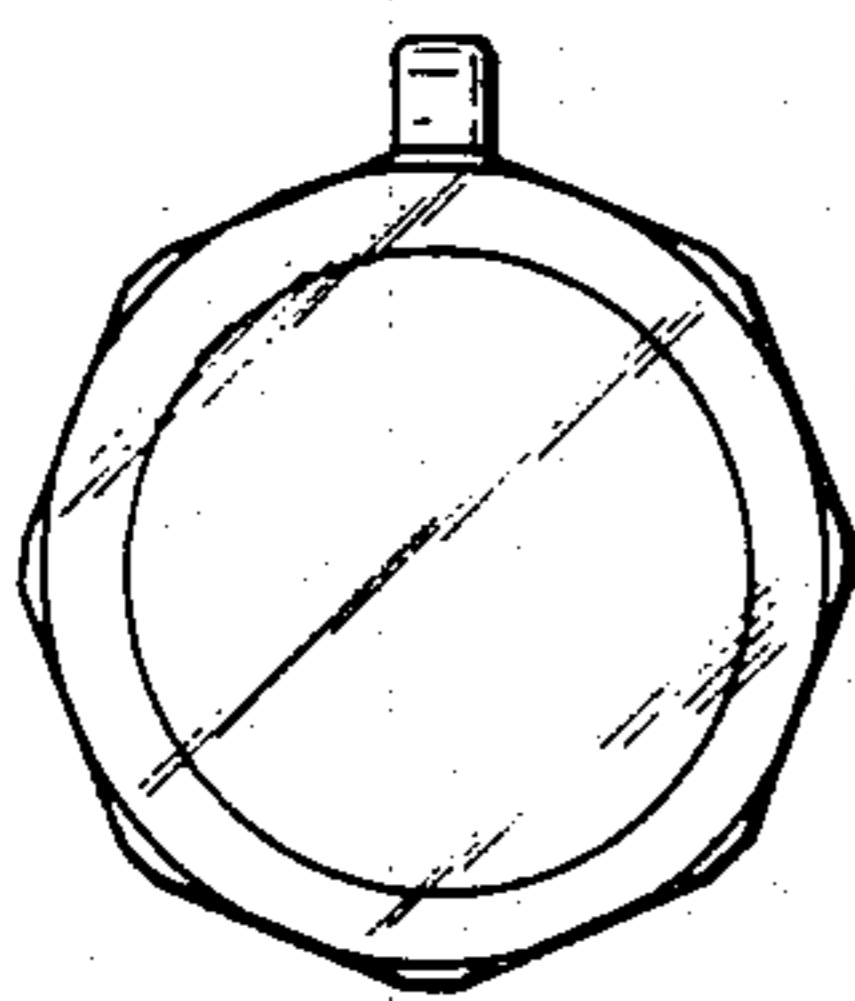

FIG. 2

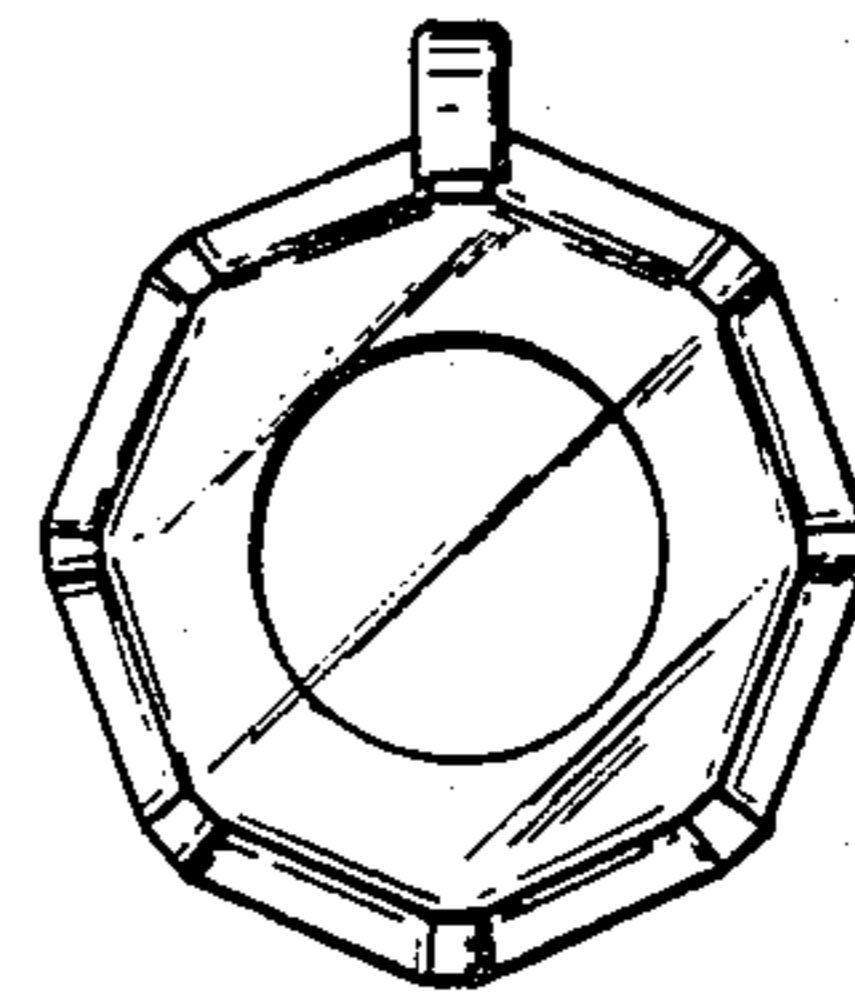

FIG. 3

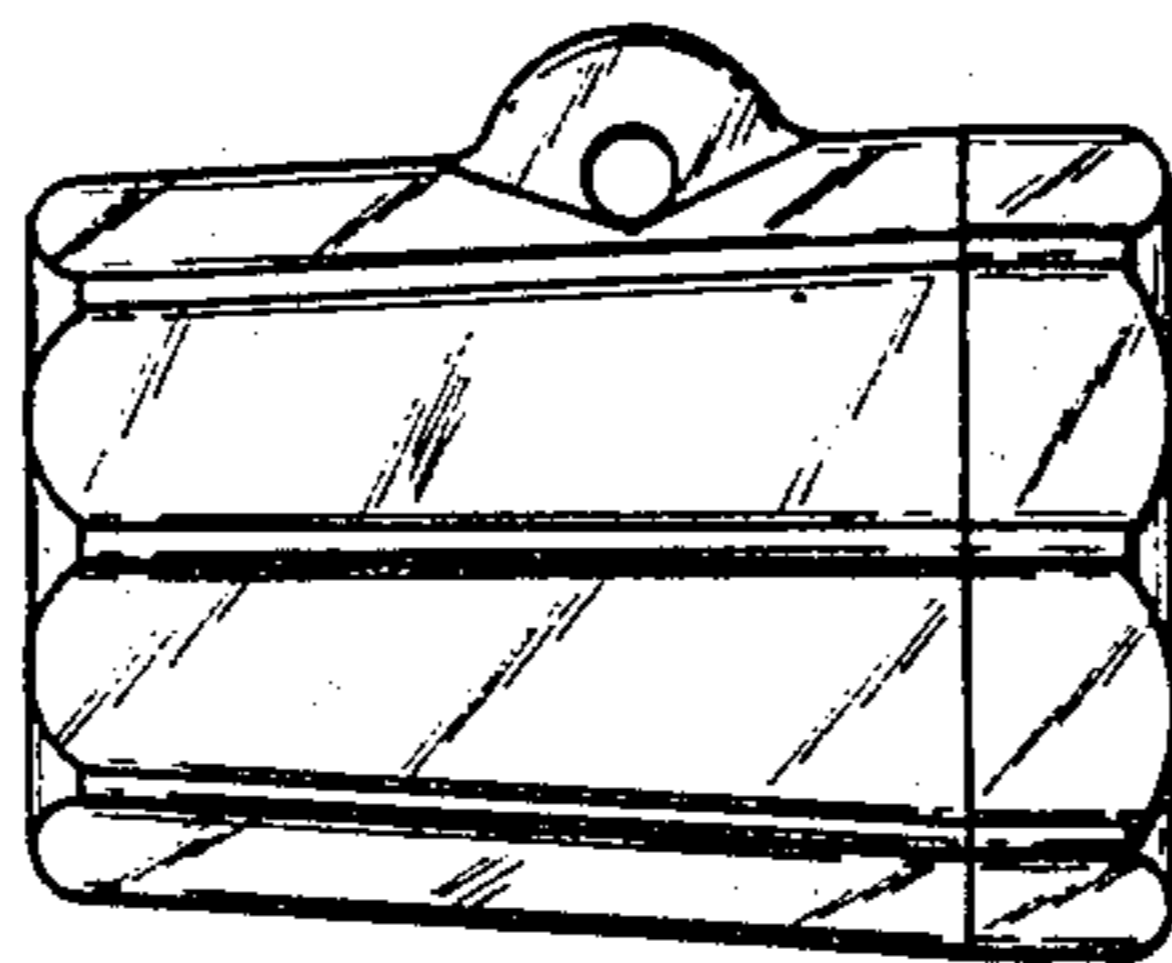

FIG. 4

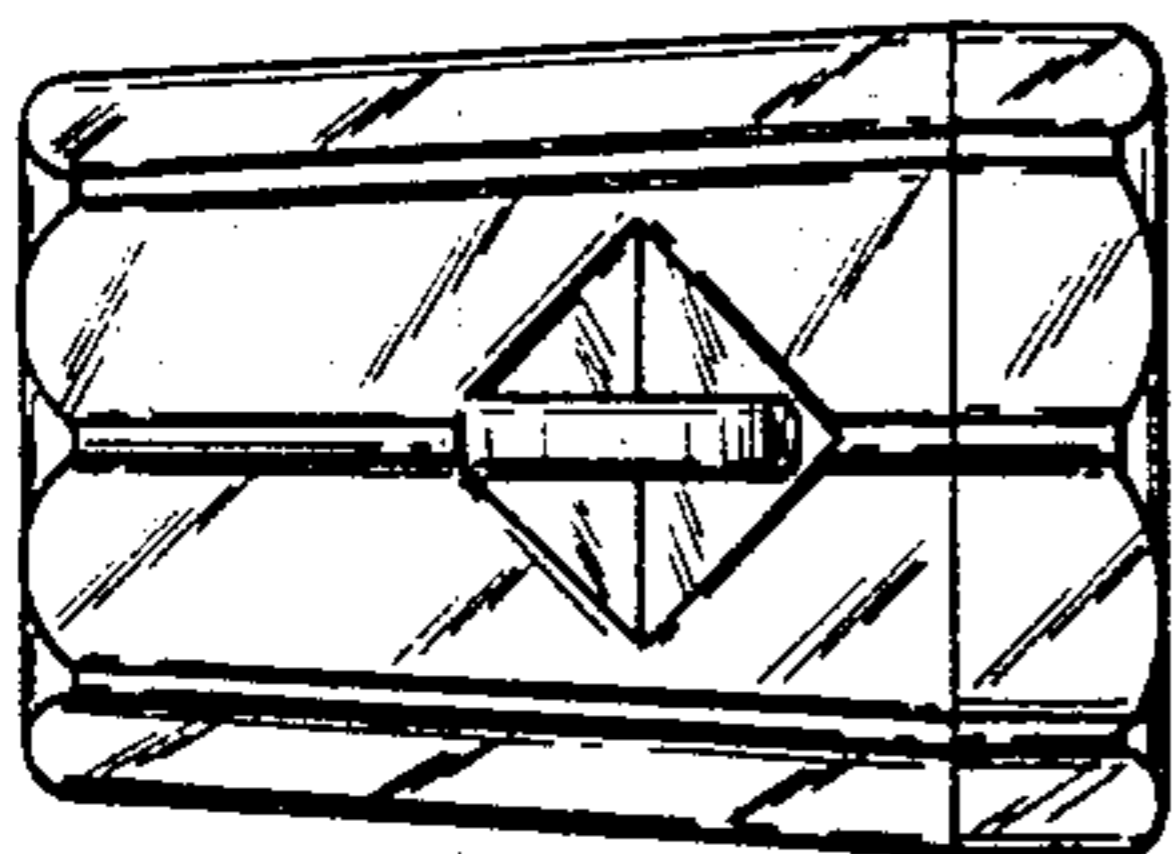

FIG. 5

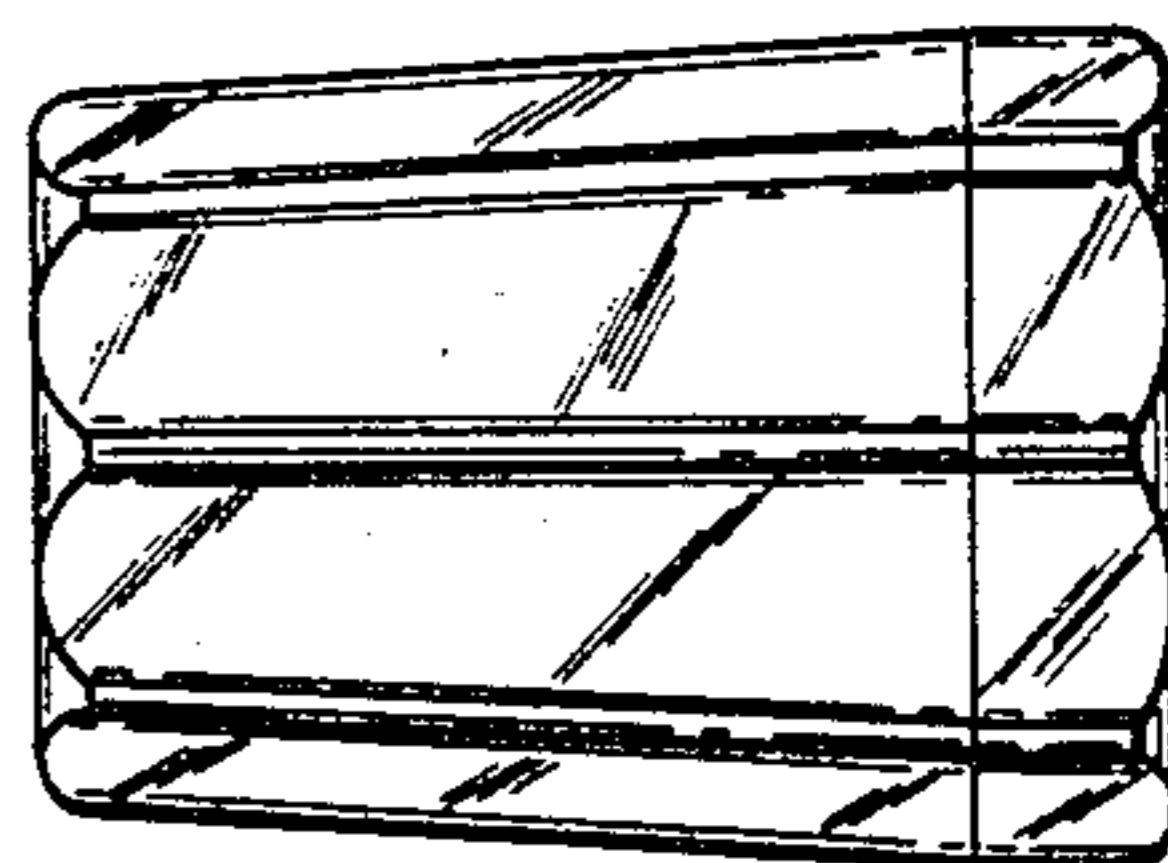

FIG. 6