

[54] GRAIN MOISTURE METER

[76] Inventor: Shigeo Suzuki, 4-1 Yamana-cho, Fukuroi 437, Japan

[**] Term: 14 Years

[21] Appl. No.: 414,776

[22] Filed: Sep. 3, 1982

[30] Foreign Application Priority Data

May 18, 1982 [GB] United Kingdom 1006783

[52] U.S. Cl. D10/56; D10/46

[58] Field of Search D10/46, 56, 78; 73/73, 73/74, 75

[56] References Cited

U.S. PATENT DOCUMENTS

- D. 244,234 5/1977 Stahel D10/70
- D. 256,783 9/1980 Moon D10/56
- 3,077,770 2/1963 Burk 73/73
- 3,427,537 2/1969 Osborne D10/56

- 4,069,716 1/1978 Vanasco 73/73 X
- 4,399,404 8/1983 Resh 73/73 X

OTHER PUBLICATIONS

Electronic Technician/Dealer, 6/78, p. 24, Multimeter at bottom right.

Primary Examiner—Nelson C. Holtje
Attorney, Agent, or Firm—Thomas J. Greer, Jr.

[57] CLAIM

The original design for a grain moisture meter, as shown and described.

DESCRIPTION

FIG. 1 is a perspective view of a grain moisture meter showing my new design;
 FIG. 2 is a top plan view thereof;
 FIG. 3 is a rear elevational view thereof;
 FIG. 4 is a front elevational view thereof;
 FIG. 5 is a left side elevational view thereof;
 FIG. 6 is a right side elevational view thereof; and
 FIG. 7 is a bottom plan view thereof.

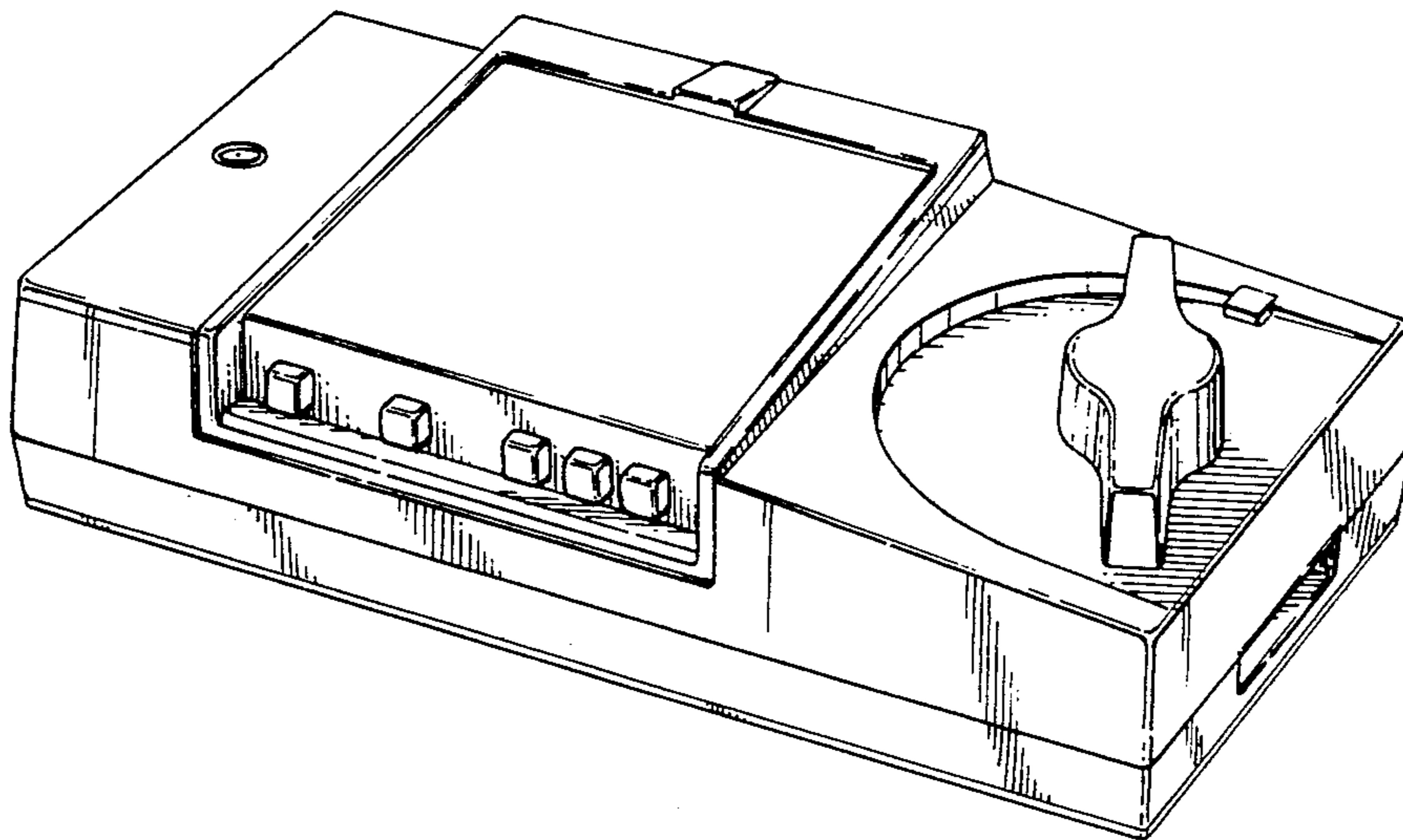

Fig. 1.

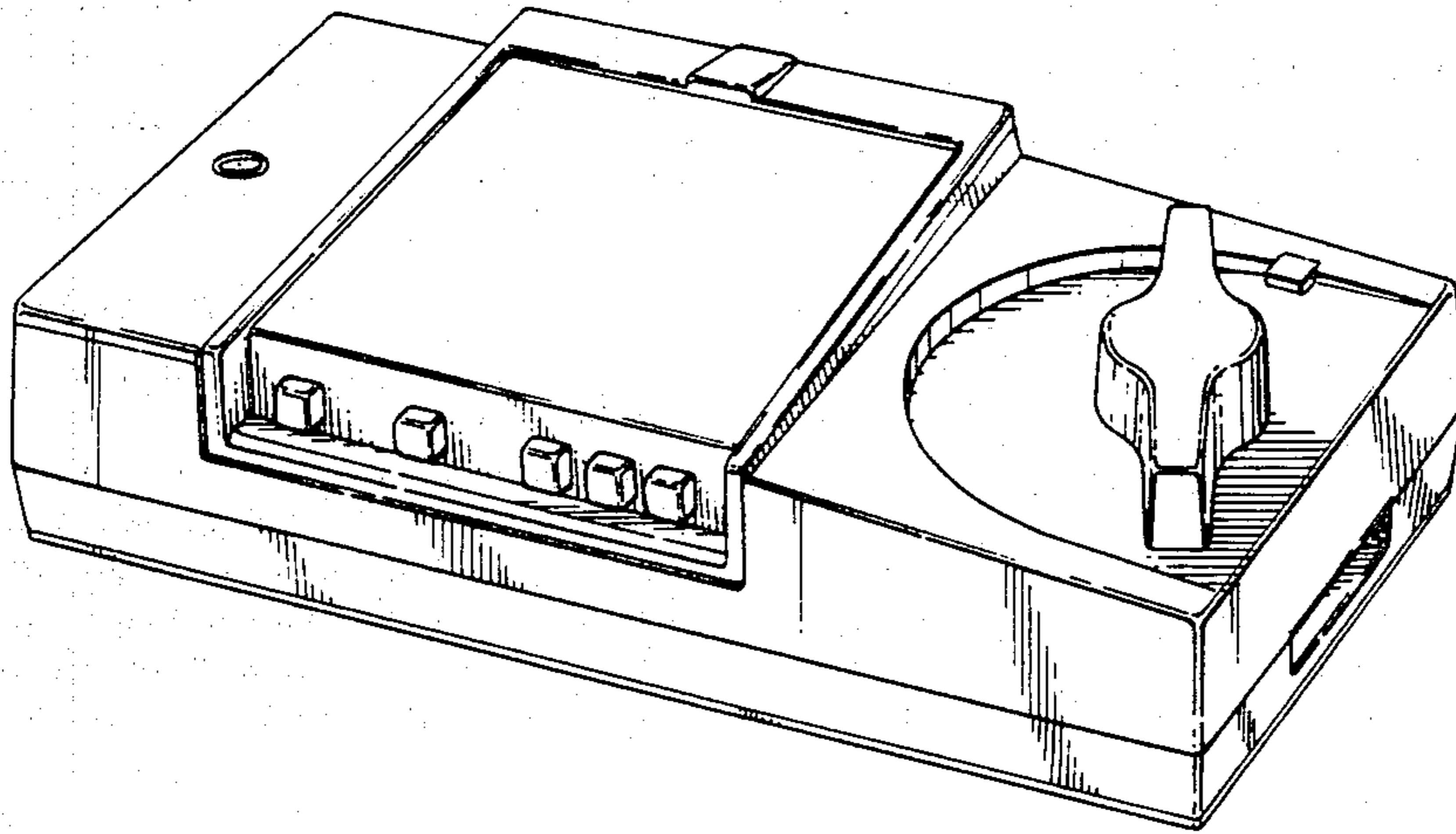

Fig. 2.

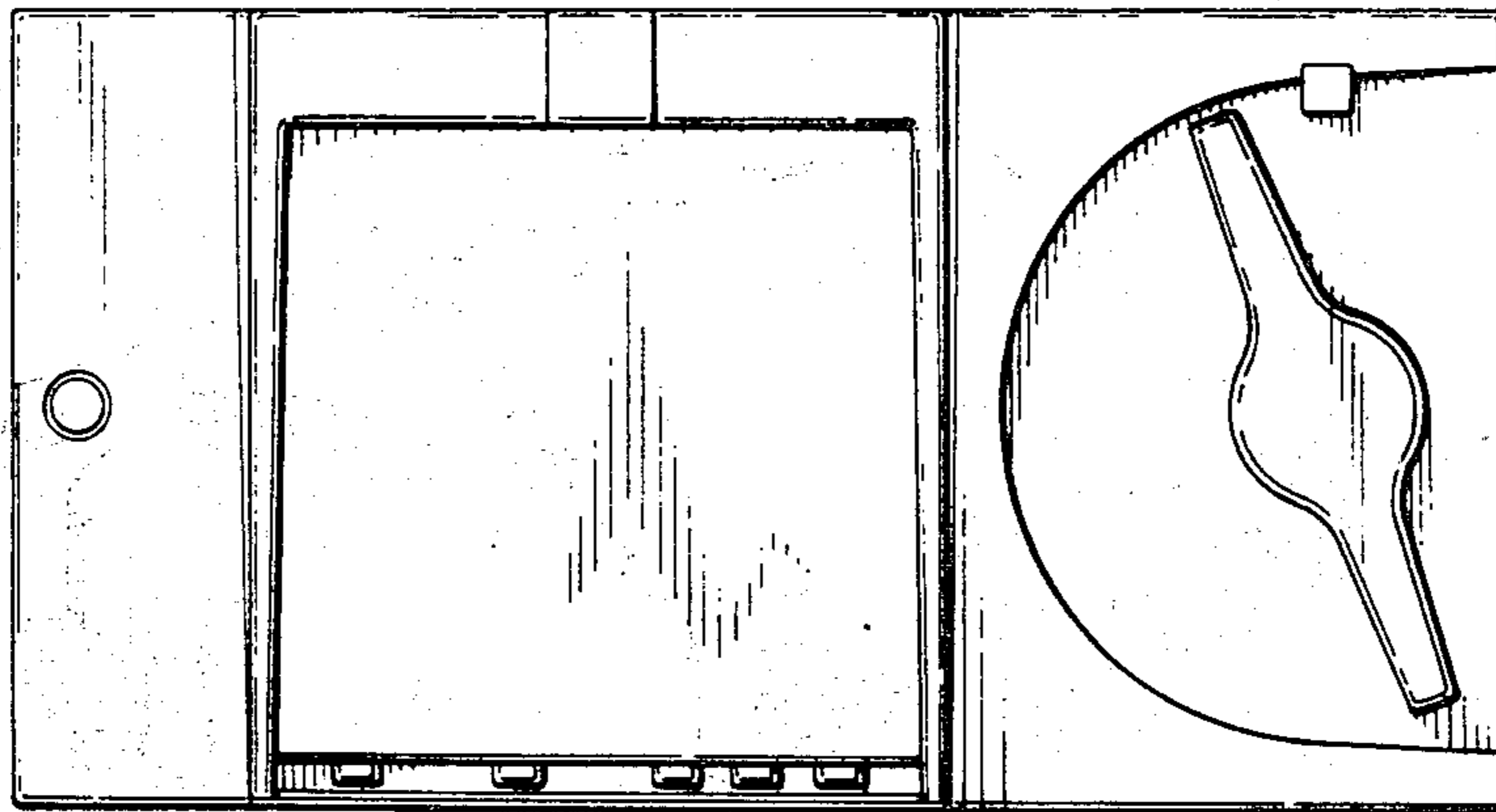

Fig. 3.

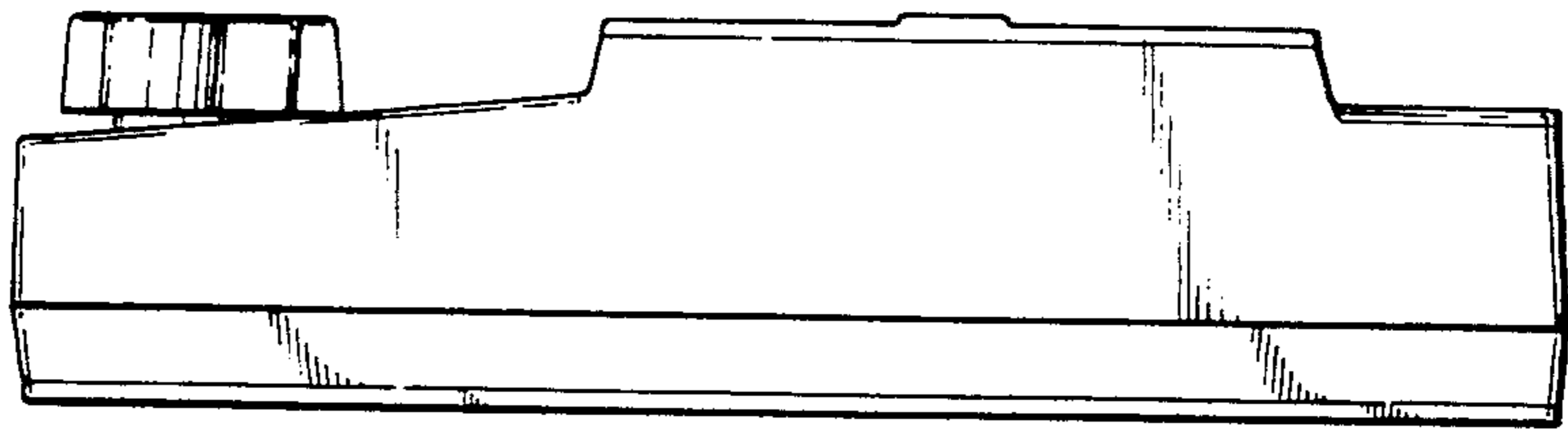

Fig. 4

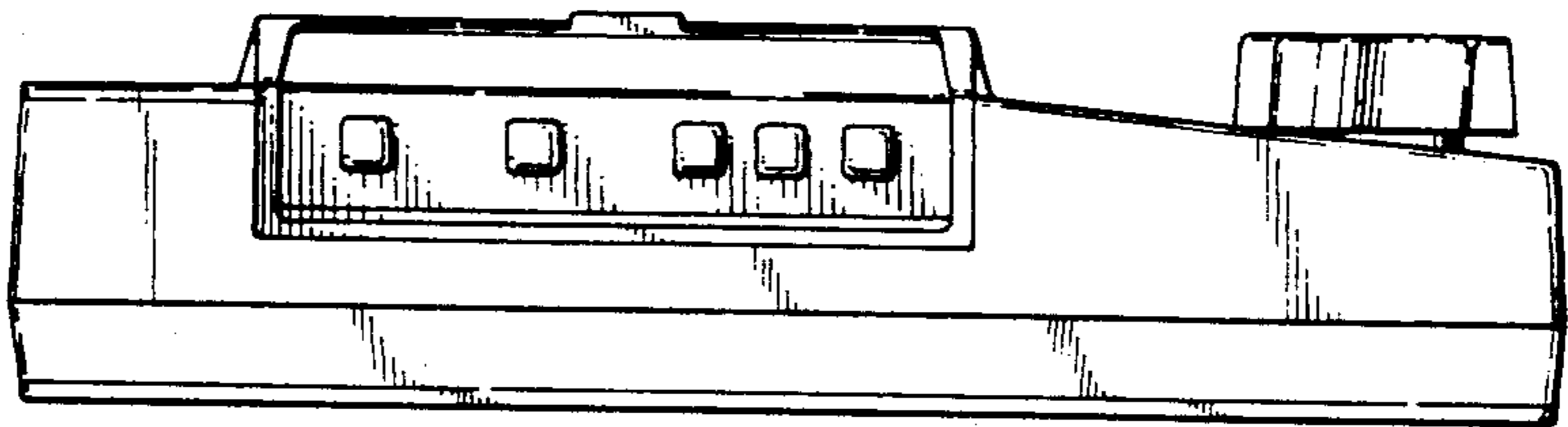

Fig. 5.

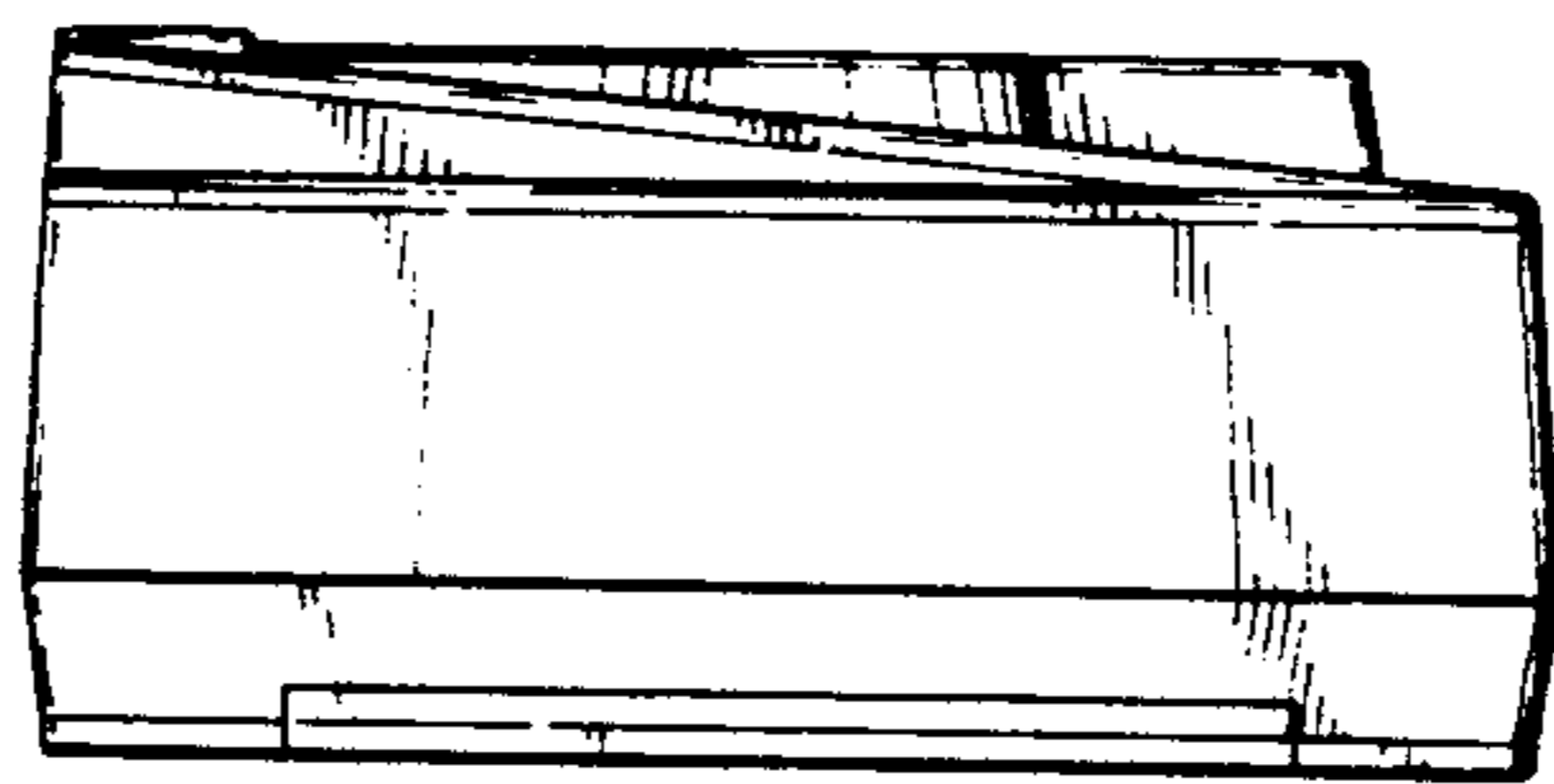

Fig. 6.

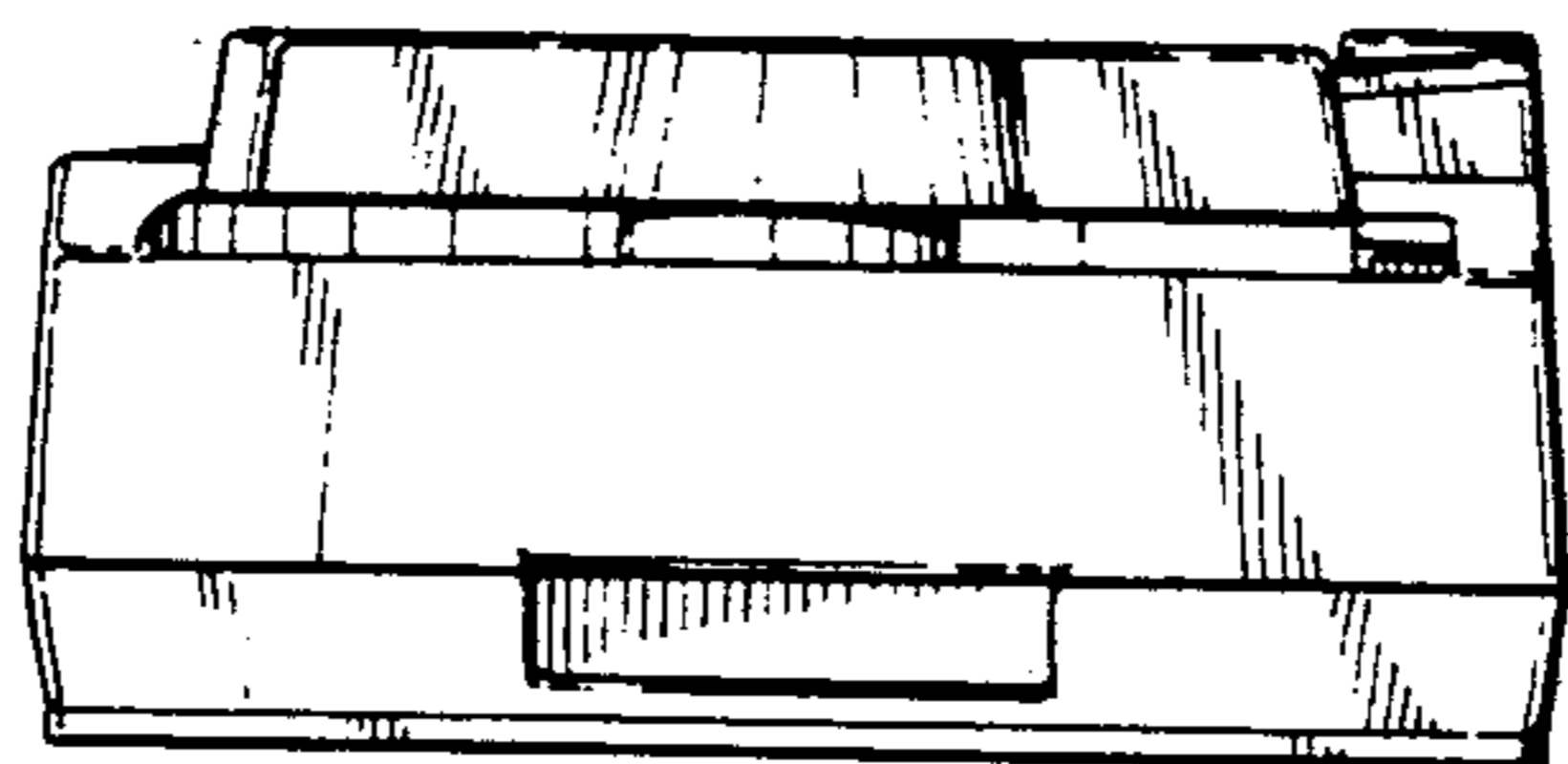

Fig. 7.

