

[54] **PLASTIC THREADED COVER FOR A CONTAINER**

[76] **Inventor: Florence Rosenstein, 67 W. Euclid St., Valley Stream, N.Y. 11580**

[\*\*] **Term: 14 Years**

[21] **Appl. No.: 443,121**

[22] **Filed: Nov. 19, 1982**

[52] **U.S. Cl. .... D9/449**

[58] **Field of Search ..... D9/447, 449, 366; 222/480, 1, 565**

[56] **References Cited**

**U.S. PATENT DOCUMENTS**

D. 96,279	7/1935	Roehrich	.....	D9/366
958,713	5/1910	Baron et al.	.....	215/237
4,284,200	8/1981	Bush et al.	.....	220/254 X
4,361,250	11/1982	Foster	.....	220/254 X

**FOREIGN PATENT DOCUMENTS**

491757 3/1954 Italy ..... 222/565

*Primary Examiner*—Melvin B. Feifer  
*Assistant Examiner*—Linda M. Titolo  
*Attorney, Agent, or Firm*—Edward H. Loveman

[57] **CLAIM**

The ornamental design of a plastic threaded cover for a container, as shown and described.

**DESCRIPTION**

FIG. 1 is a perspective view of a plastic threaded cover for a container showing my new design;  
FIG. 2 is a top plan view thereof;  
FIG. 3 is a bottom plan view thereof;  
FIG. 4 is a left elevational side view thereof;  
FIG. 5 is a front elevational view thereof; and  
FIG. 6 is a bottom perspective view thereof.  
The rear view is not shown because it is a mirror image of the front view.

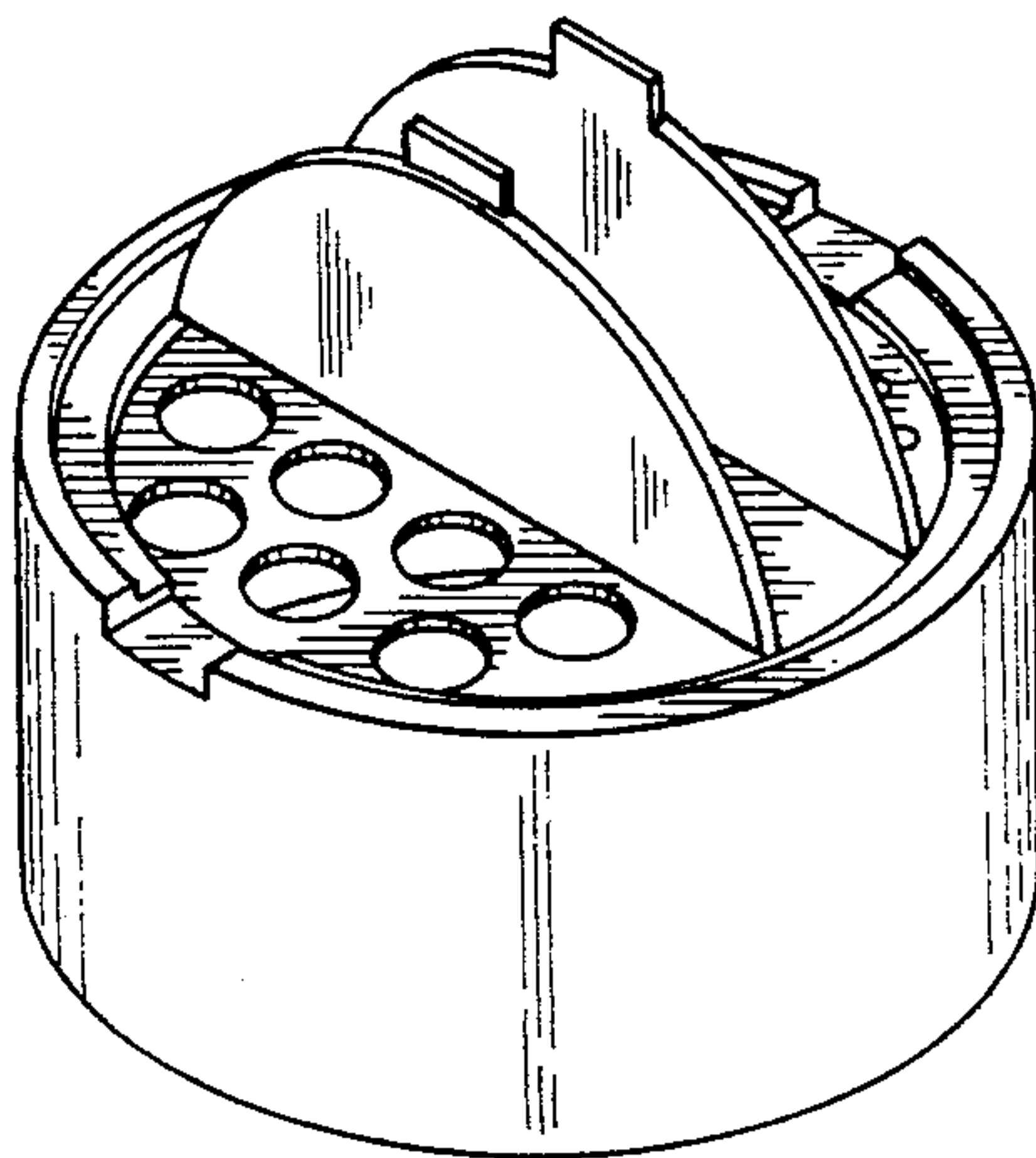

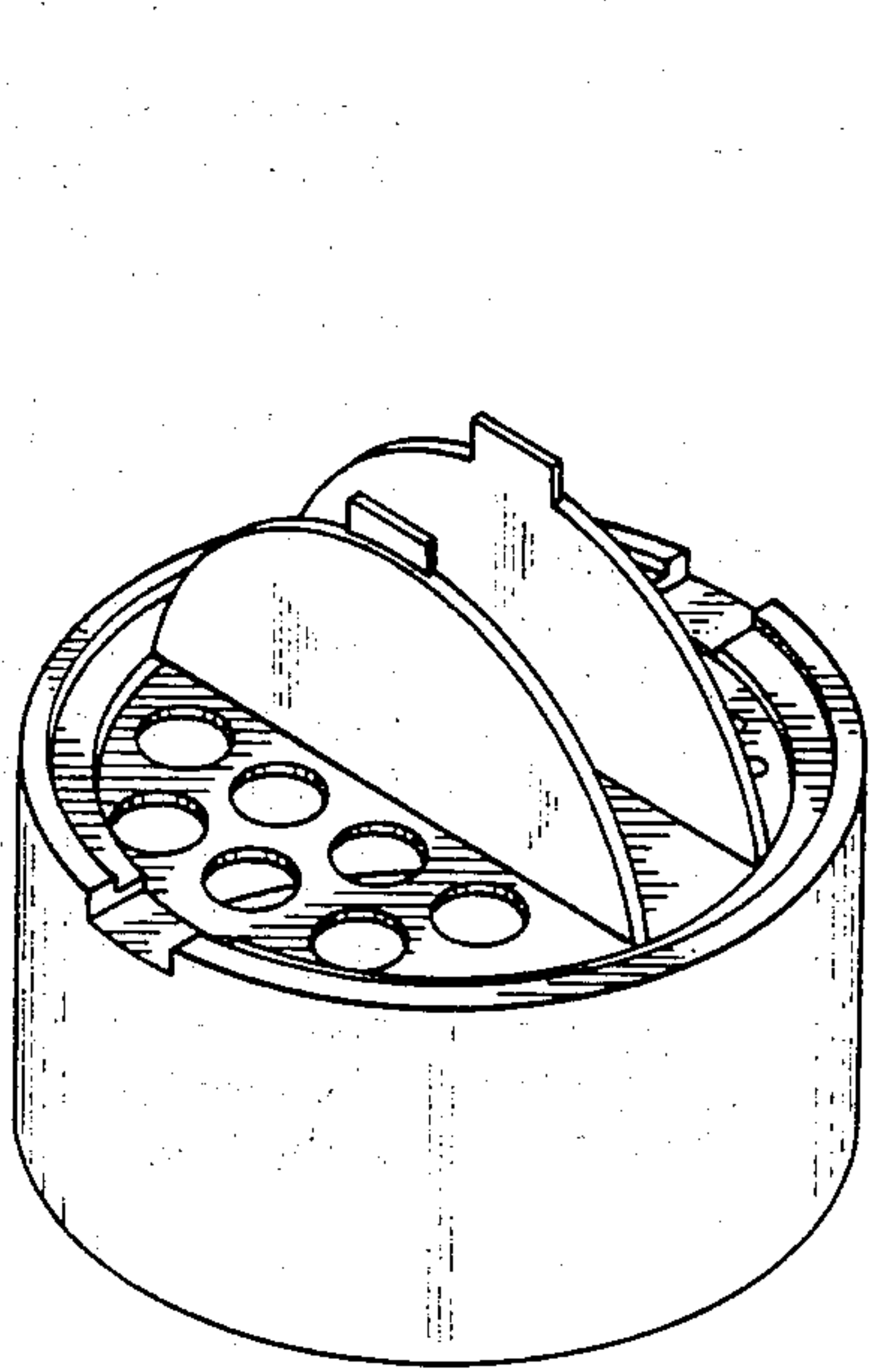

FIG. 1

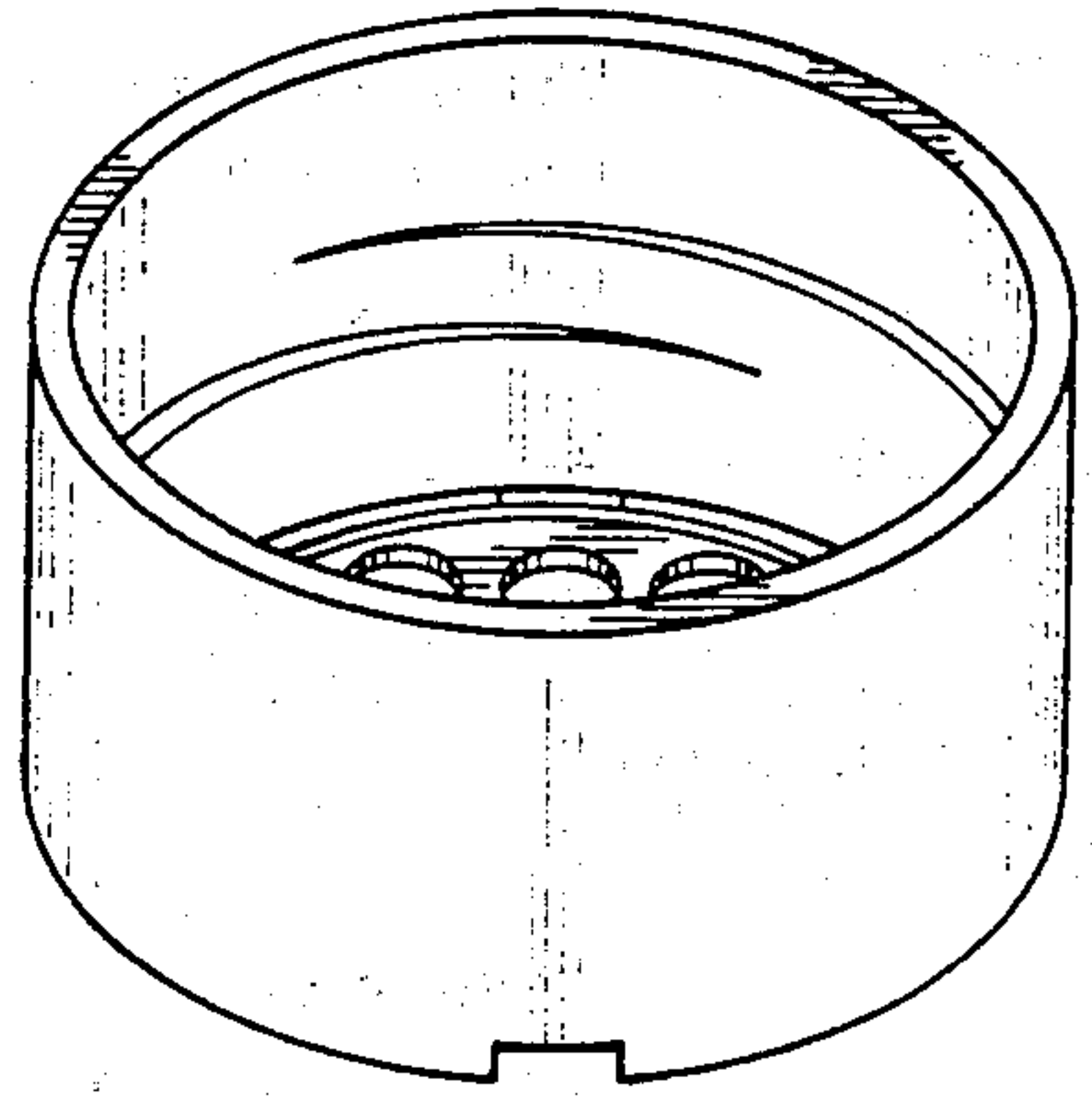

FIG. 6

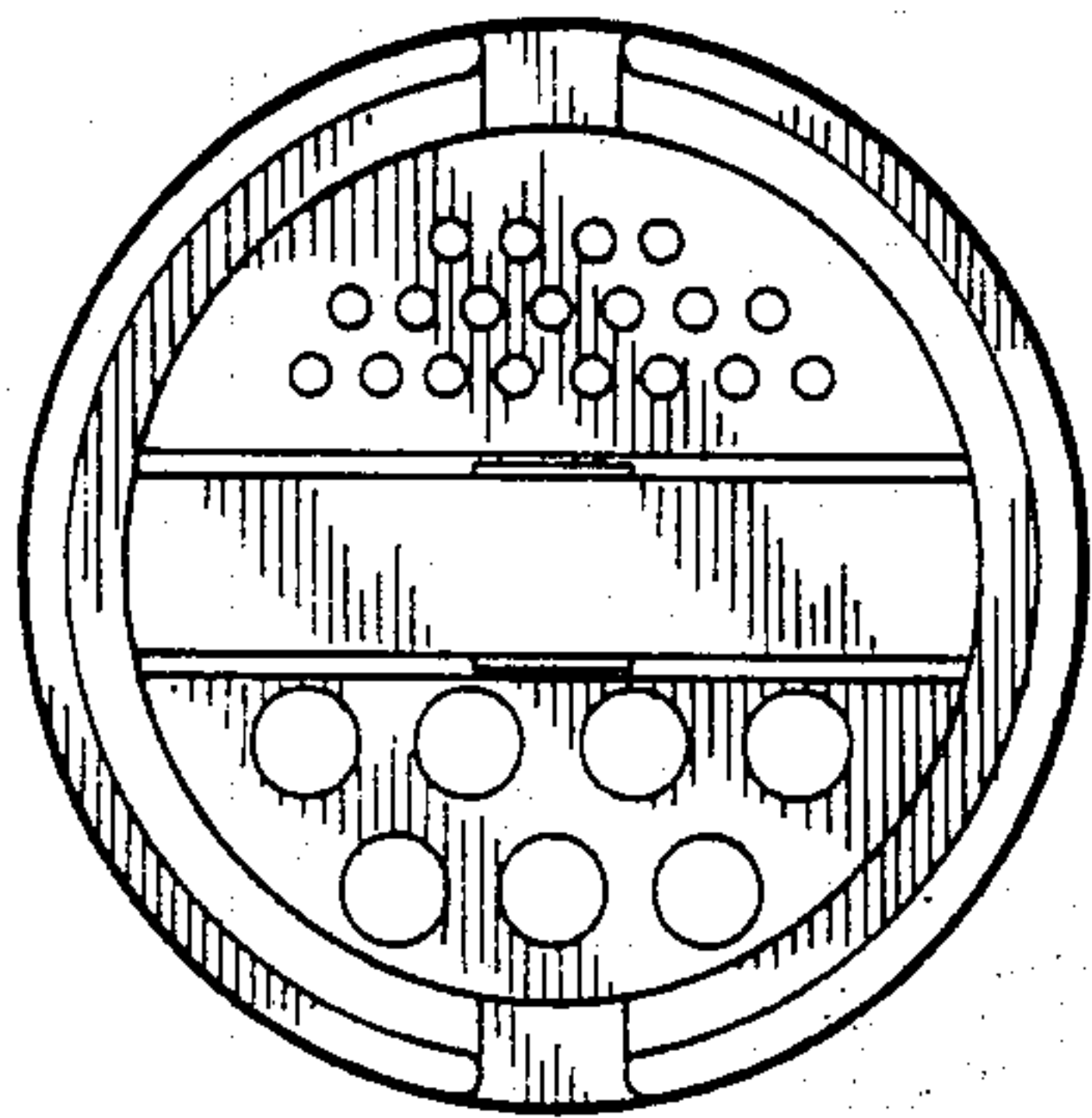

FIG. 2

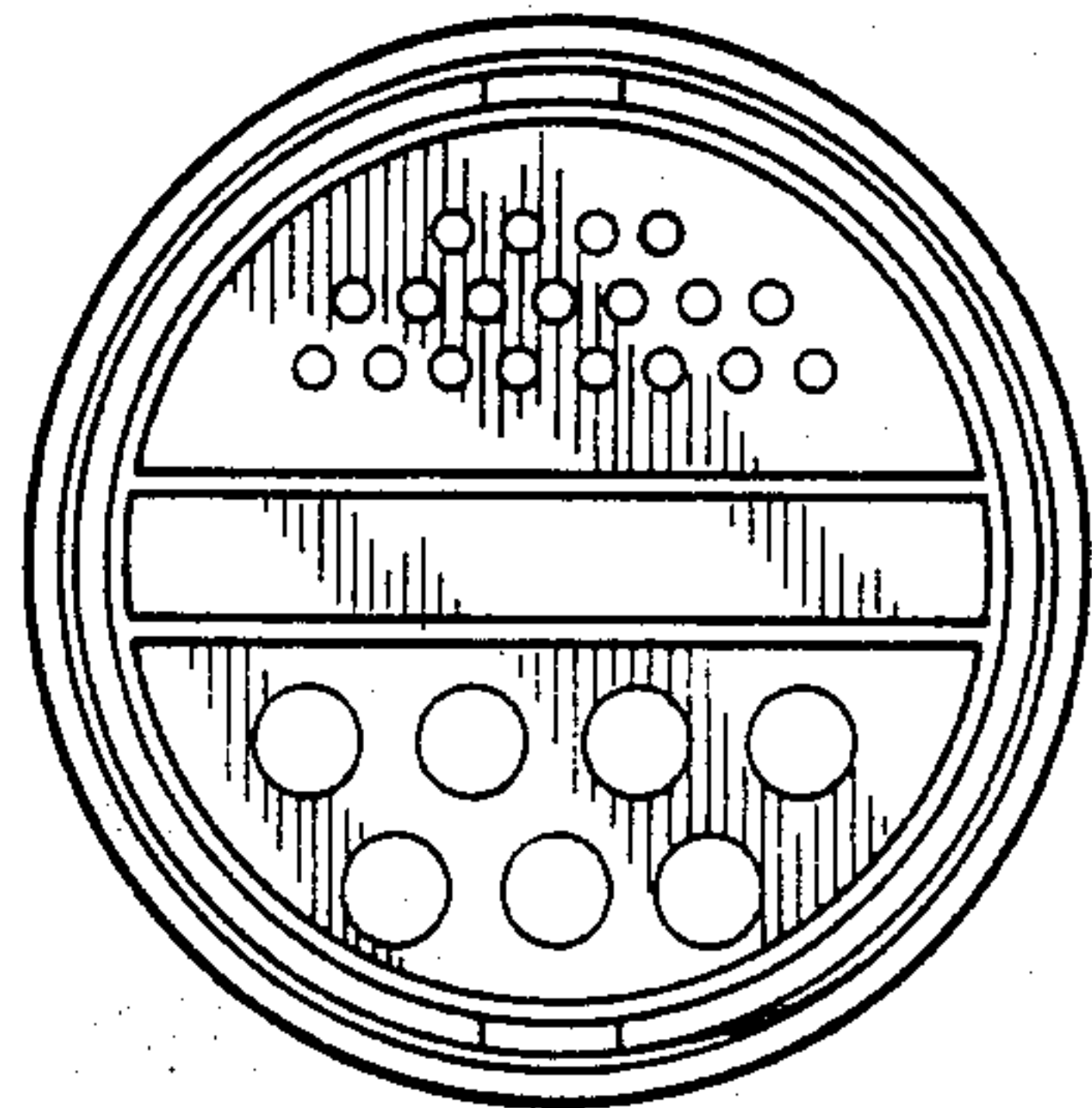

FIG. 3

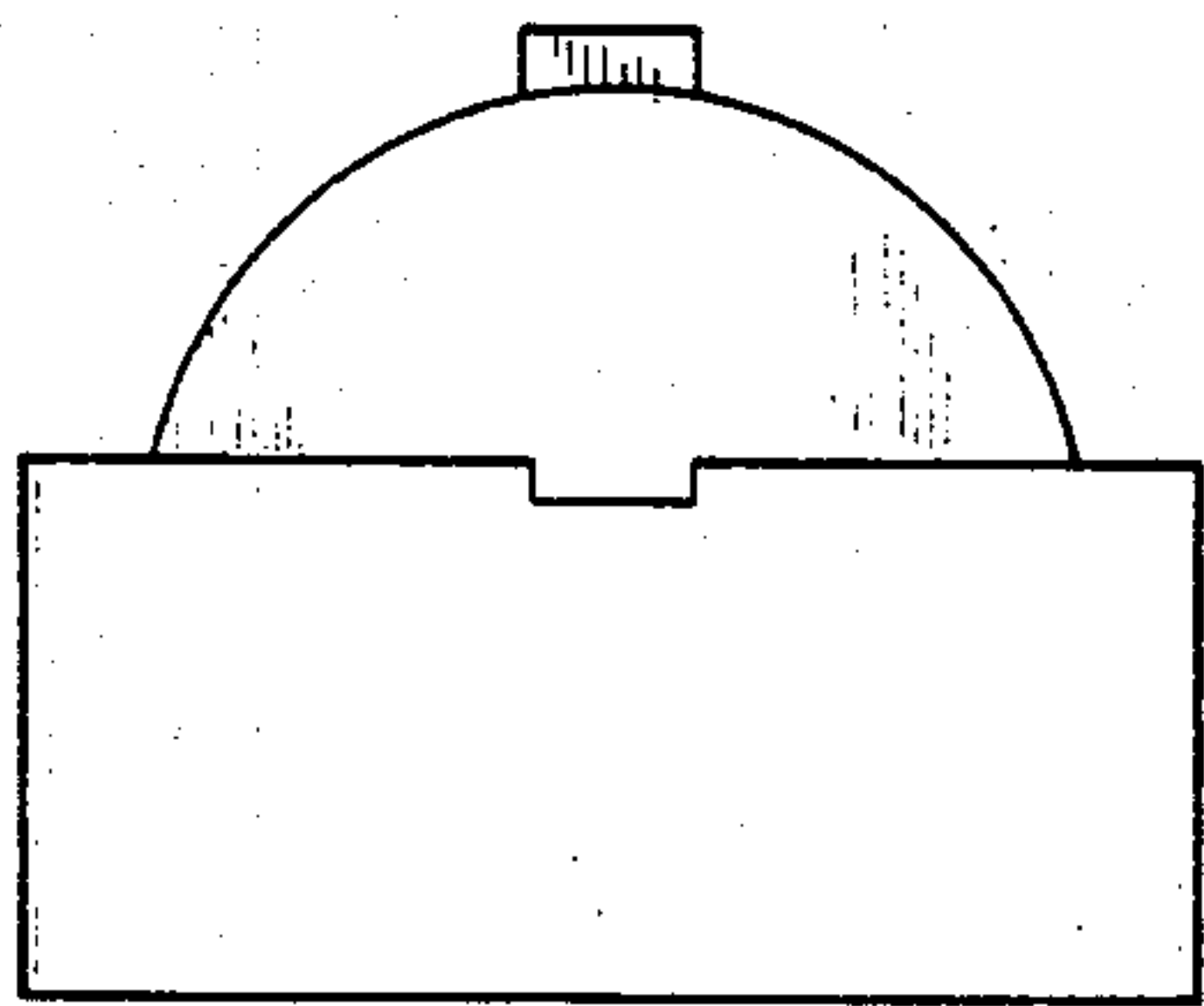

FIG. 4

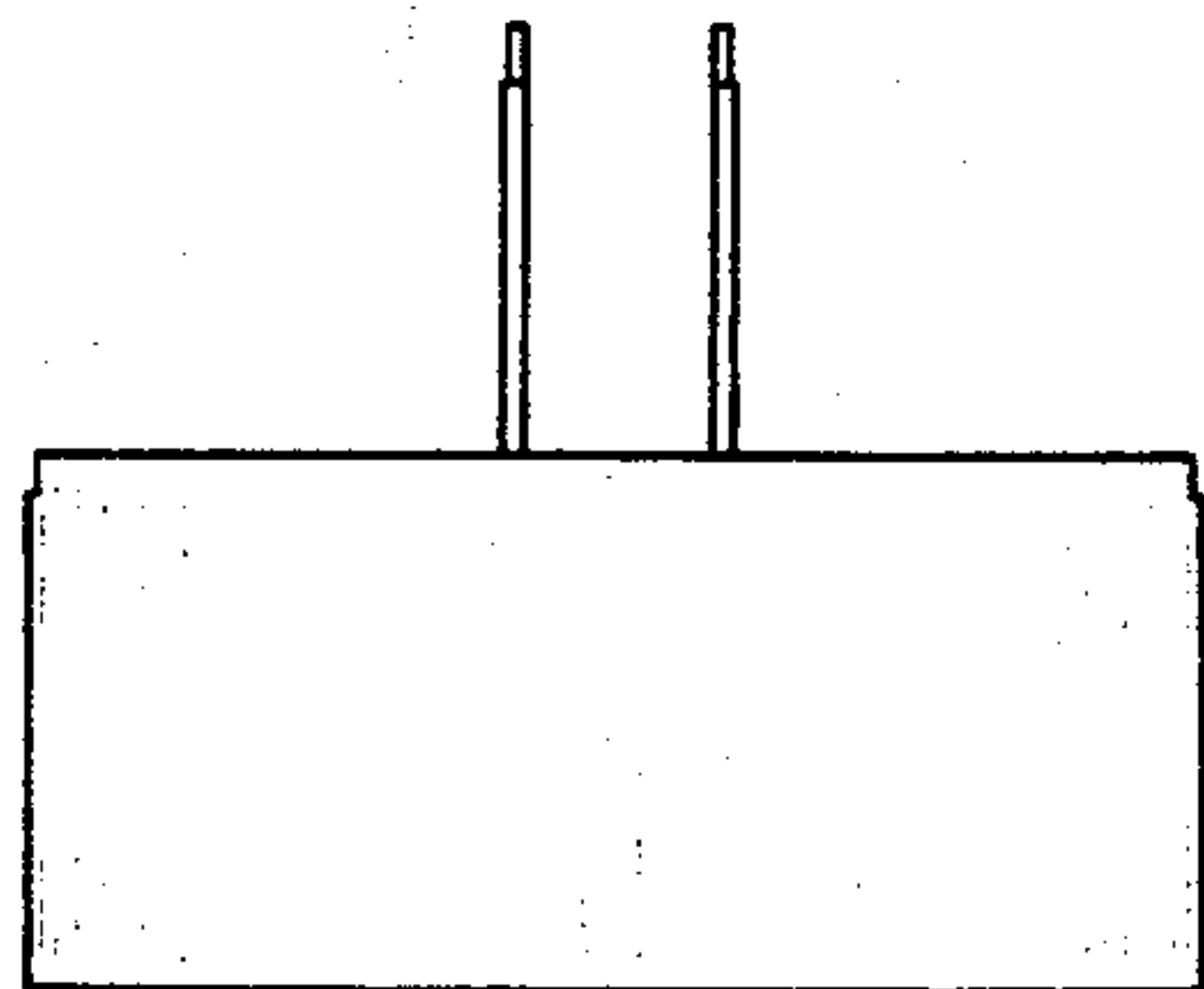

FIG. 5