

[54] SEAT  
[75] Inventor: Victor A. Milles, Wil, Switzerland  
[73] Assignee: Fratelli Saporiti Industria  
Arredamenti di Saporiti Sergio E  
Giorgio S.N.C., Besnate, Italy  
[\*\*] Term: 14 Years  
[21] Appl. No.: 416,445  
[22] Filed: Sep. 10, 1982  
[52] U.S. Cl. .... D6/334; D6/364;  
D6/381  
[58] Field of Search ..... D6/47-78;  
297/232, 233

[56] References Cited

U.S. PATENT DOCUMENTS

D. 247,835 5/1978 Offredi ..... D6/67  
D. 251,519 4/1979 Radaelli ..... D6/67

OTHER PUBLICATIONS

Arbitare, May 1979, p. 126, Sofa by Gölz et al.

Primary Examiner—Bruce W. Dunkins

Attorney, Agent, or Firm—Kuhn, Muller and Bazerman

[57] CLAIM

The ornamental design for a seat, as shown and described.

DESCRIPTION

FIG. 1 is a front perspective view of a seat in the form of a chair without arm rests showing my design;

FIG. 2 is a right side perspective view thereof;  
FIG. 3 is a rear perspective view thereof; and  
FIG. 4 is a top plan view thereof;  
FIG. 5 is a front perspective view of a second embodiment of my design in the form of a chair having arm rests;  
FIG. 6 is a right side view thereof;  
FIG. 7 is a top plan view thereof; and  
FIG. 8 is a rear perspective view thereof;  
FIG. 9 is a front perspective view of a third embodiment of my design in the form of a settee, or loveseat, without arm rests;  
FIG. 10 is a right side perspective view thereof;  
FIG. 11 is a rear perspective view thereof; and  
FIG. 12 is a top plan view thereof;  
FIG. 13 is a front perspective view of a fourth embodiment of my design in the form of a settee, or loveseat, having arm rests;  
FIG. 14 is a side perspective view thereof;  
FIG. 15 is a rear elevation view thereof; and  
FIG. 16 is a top plan view thereof;  
FIG. 17 is a front perspective view of a fifth embodiment of my design in the form of a sofa without arm rests;  
FIG. 18 is a right side perspective view thereof;  
FIG. 19 is a rear elevation view thereof; and  
FIG. 20 is a top plan view thereof;  
FIG. 21 is a front perspective view of a sixth embodiment of my design in the form of a sofa having arm rests;  
FIG. 22 is a right side perspective view thereof;  
FIG. 23 is a rear elevation view thereof; and  
FIG. 24 is a top plan view thereof.



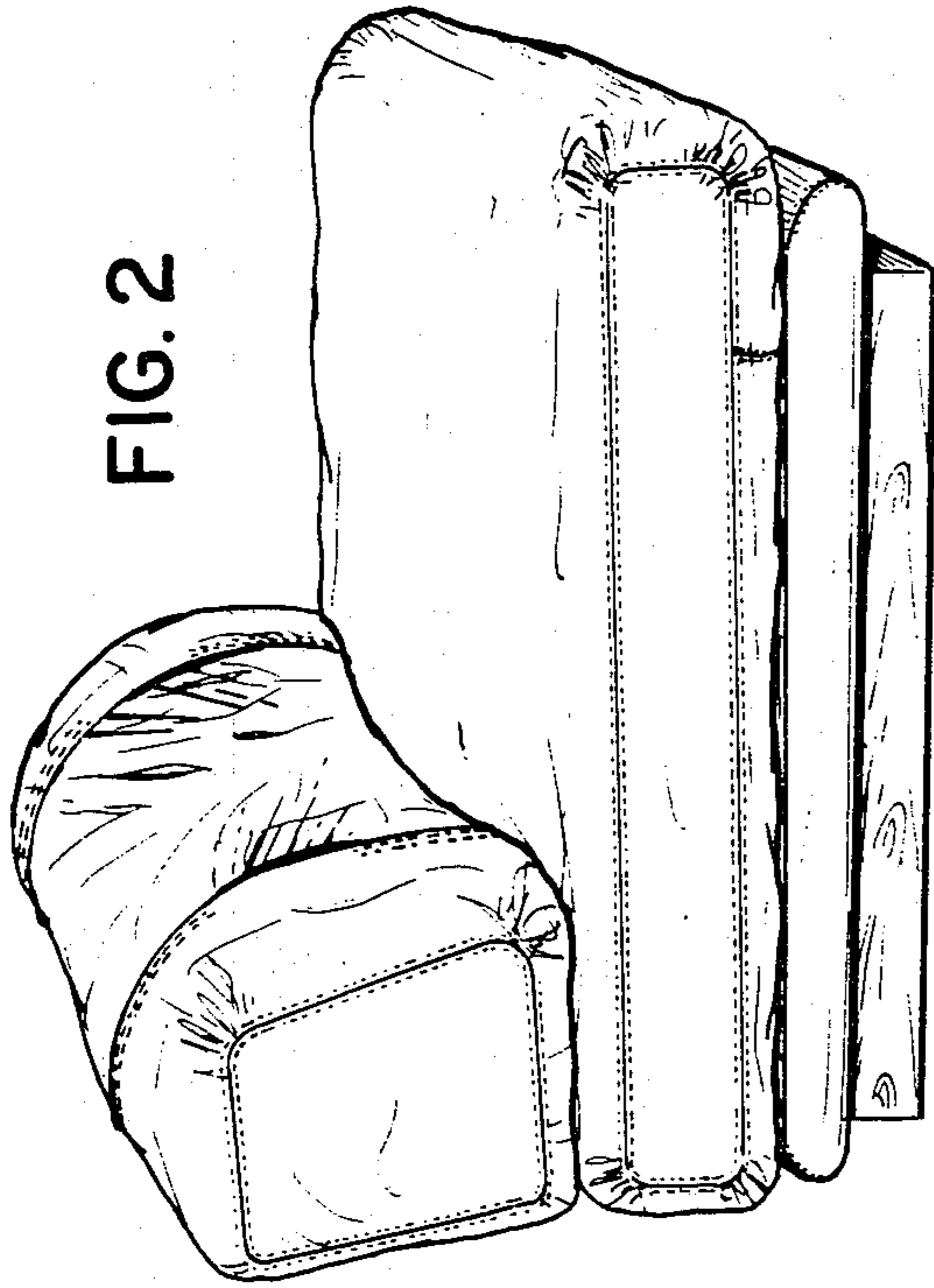

FIG. 2

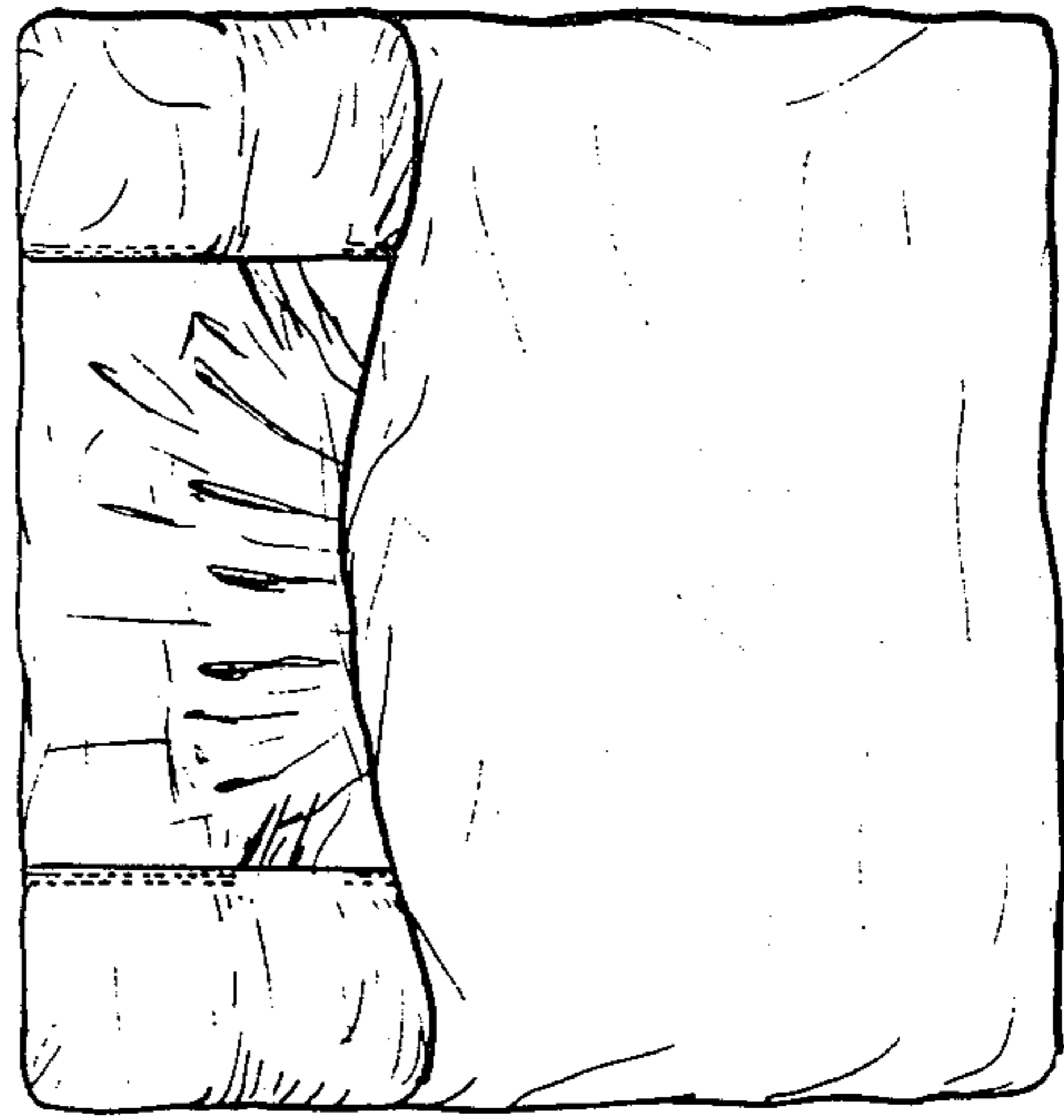

FIG. 4

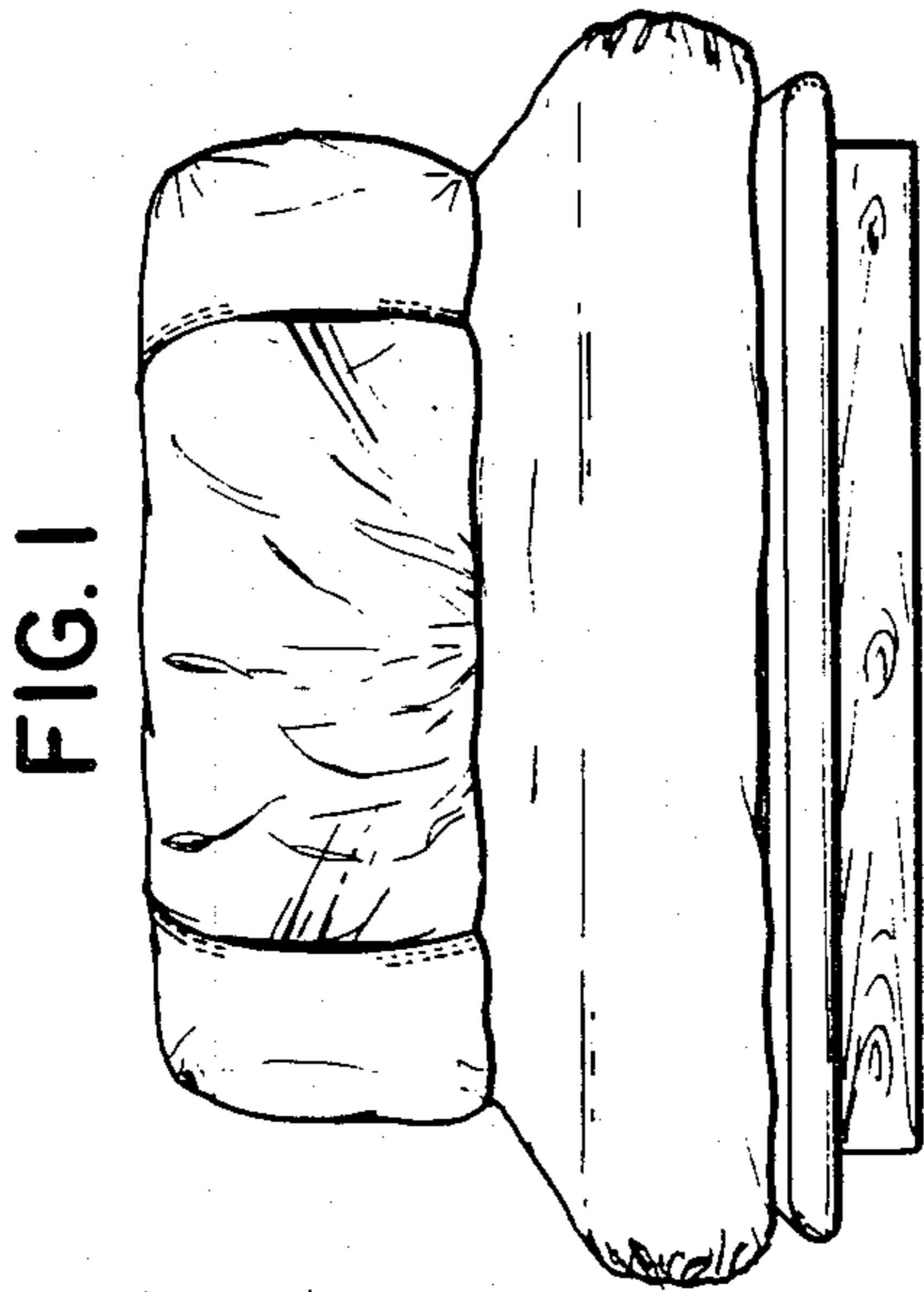

FIG. 3

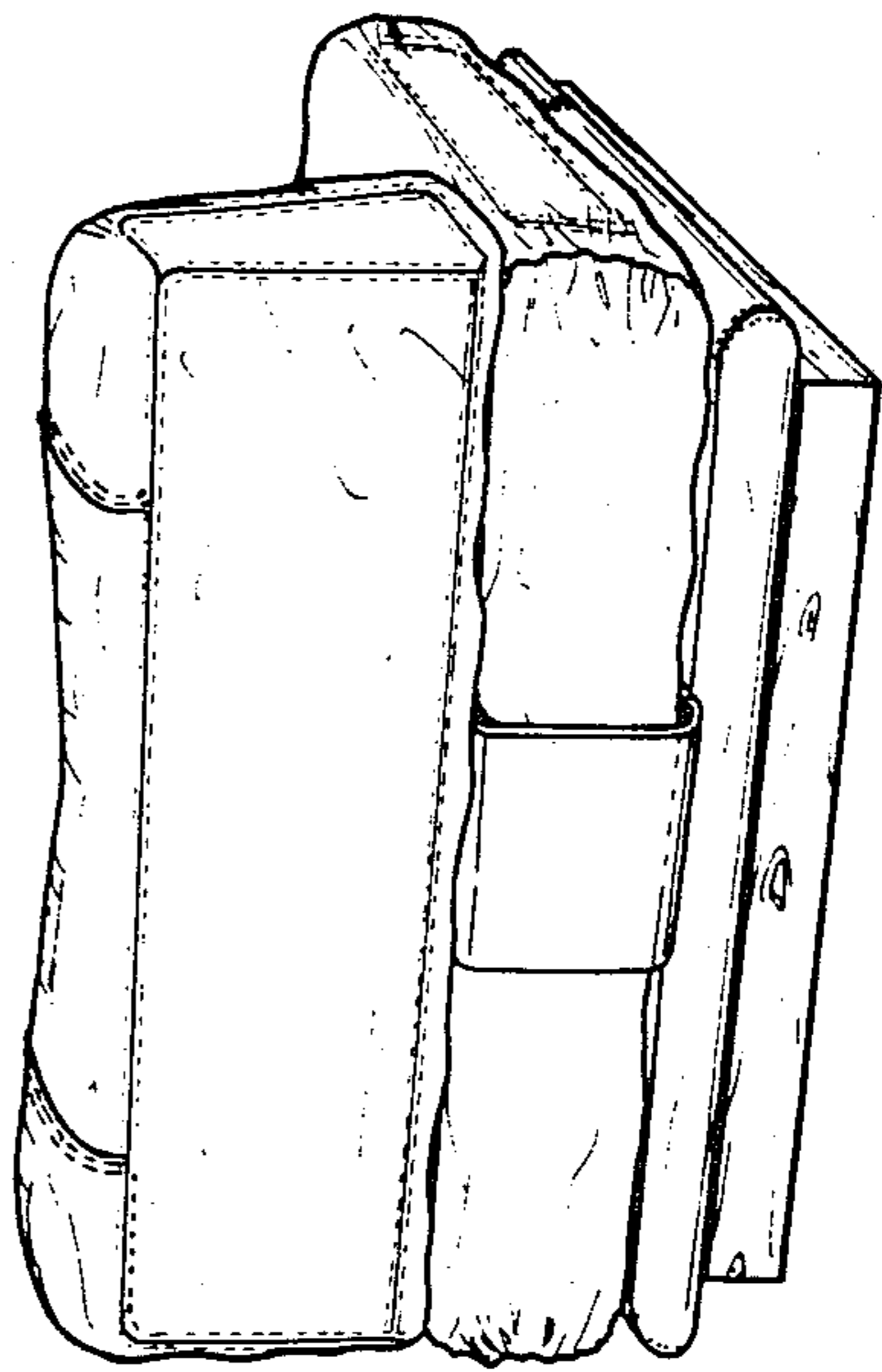

FIG. 5

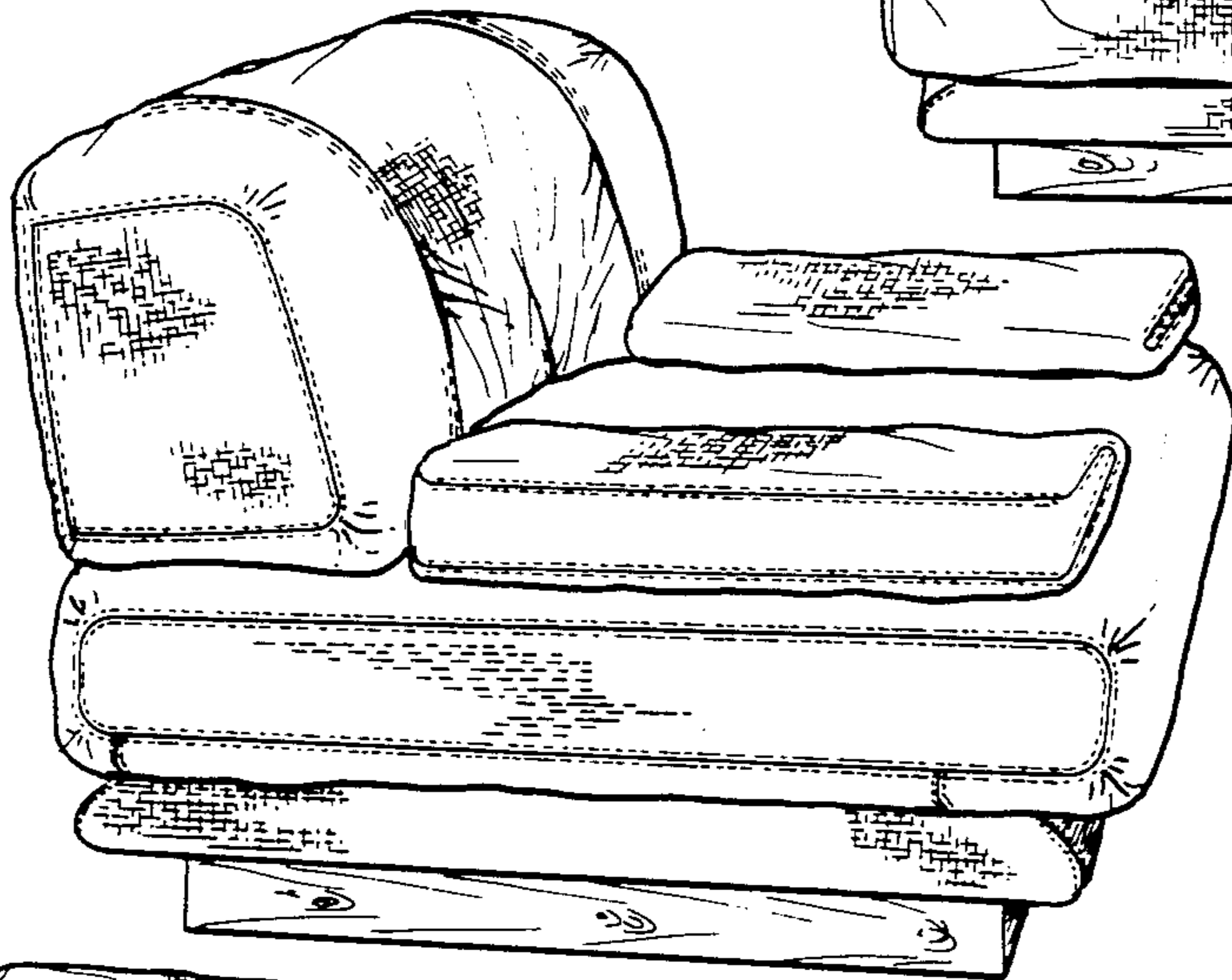
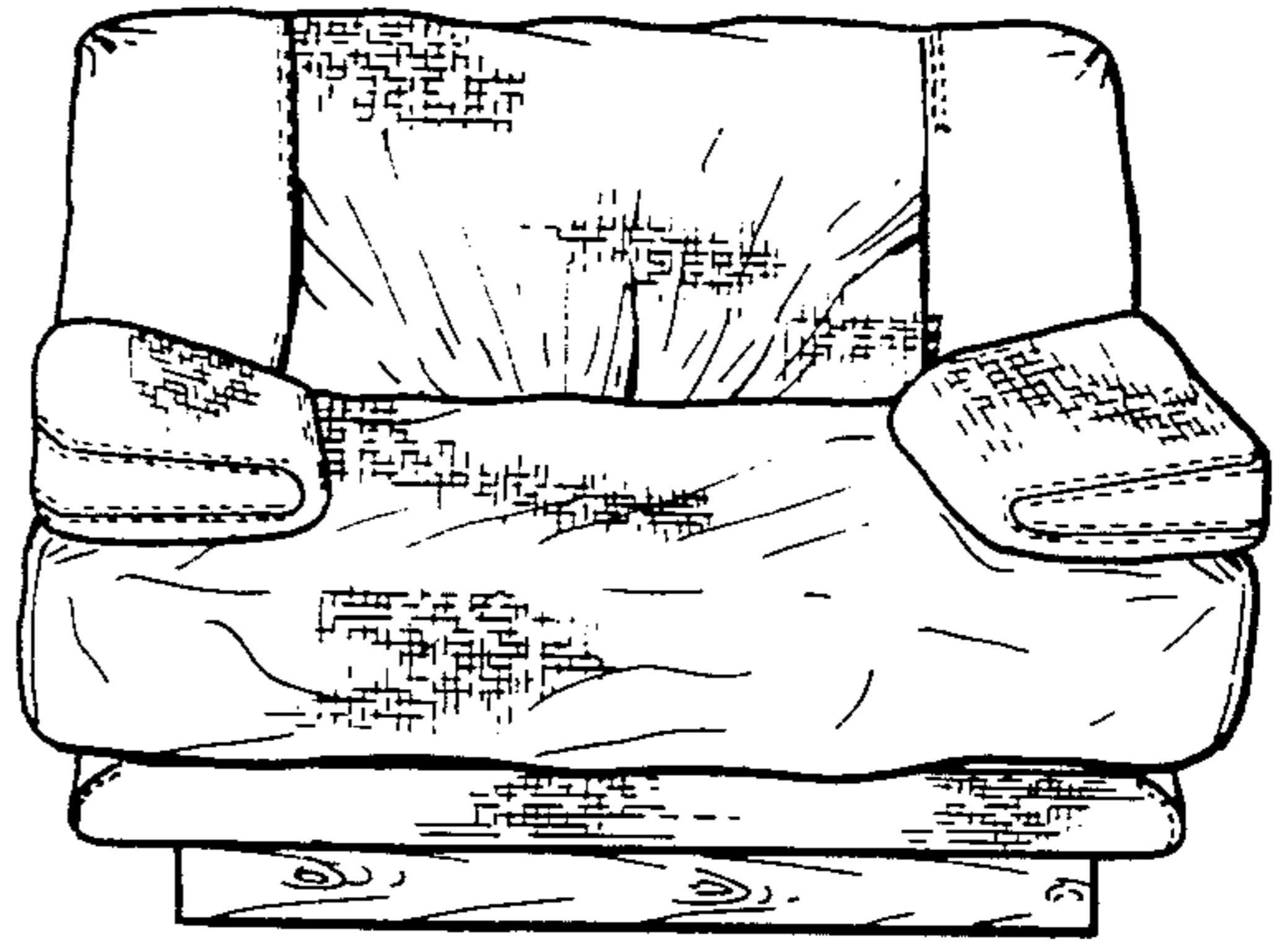

FIG. 6

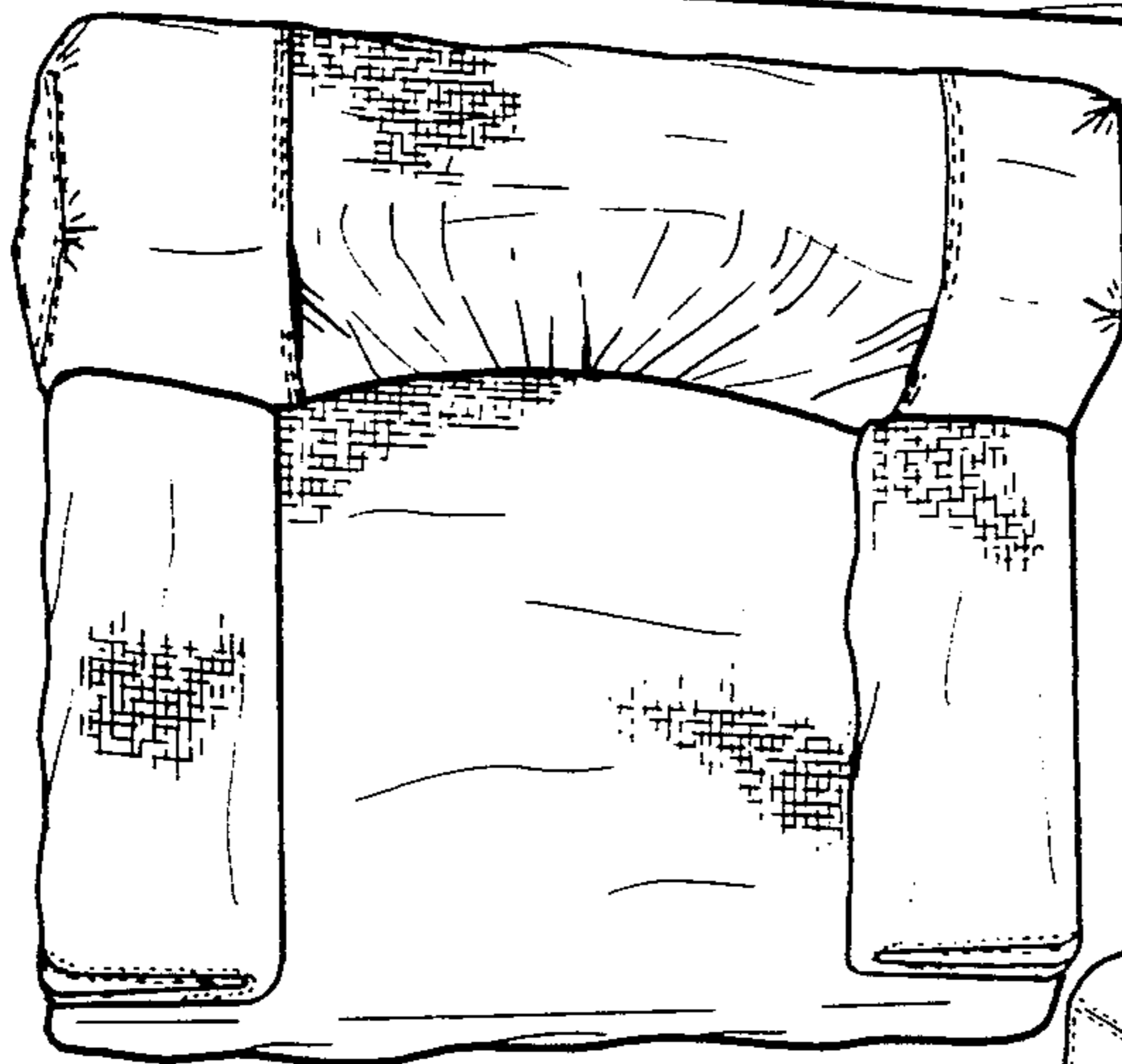

FIG. 7

FIG. 8

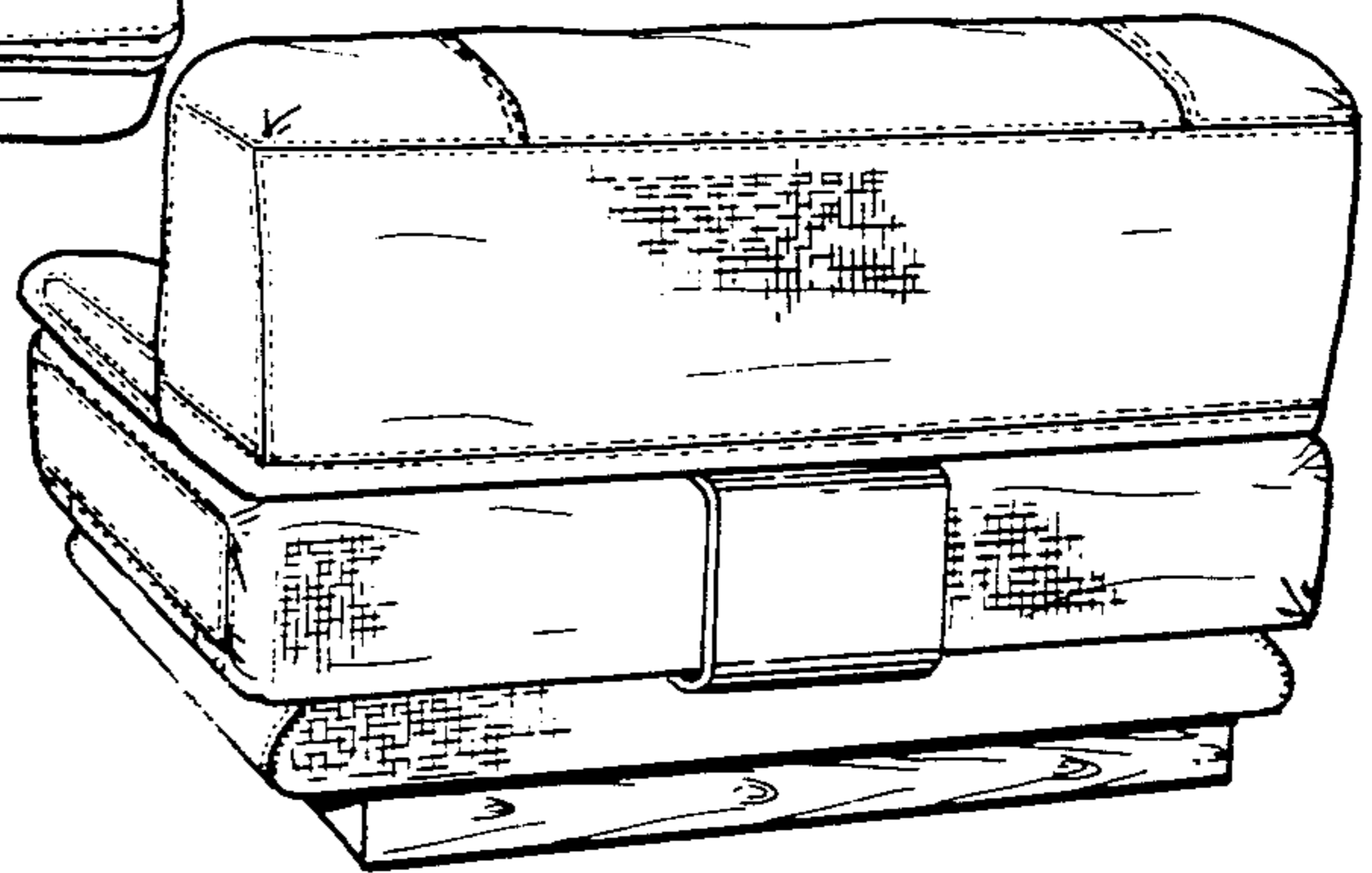

FIG. 9

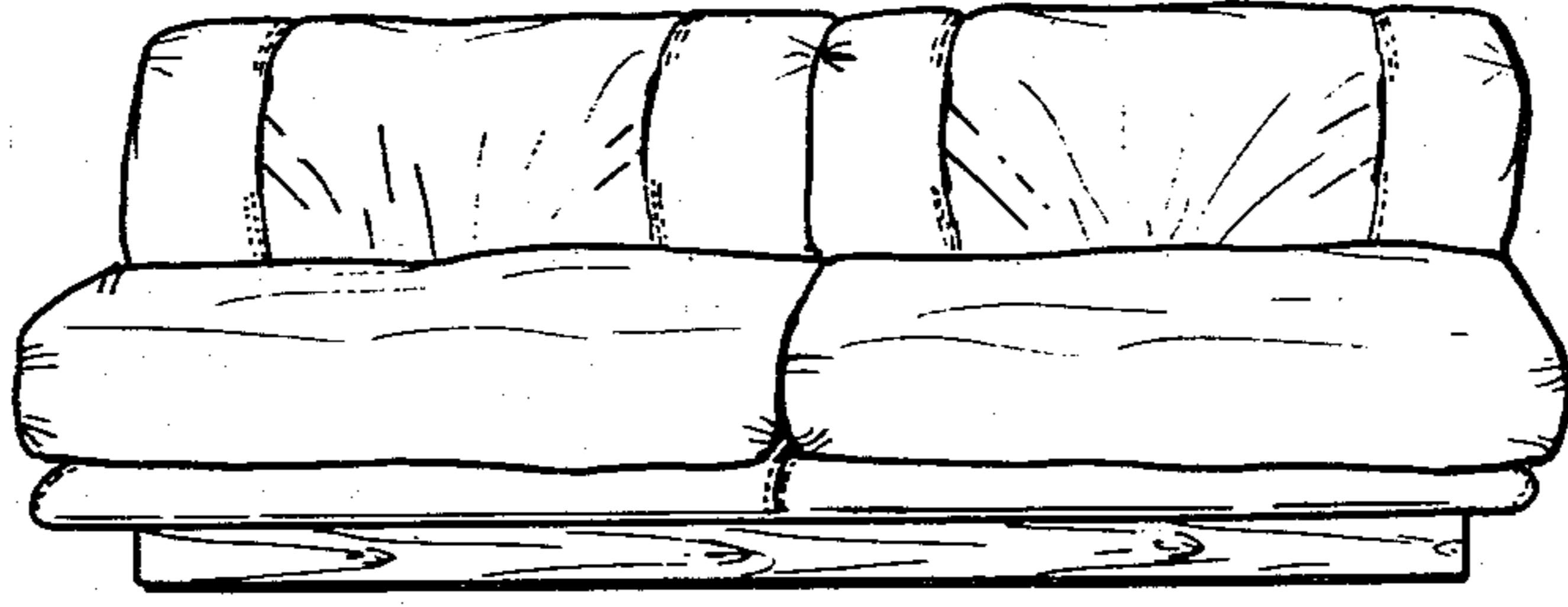

FIG. 10

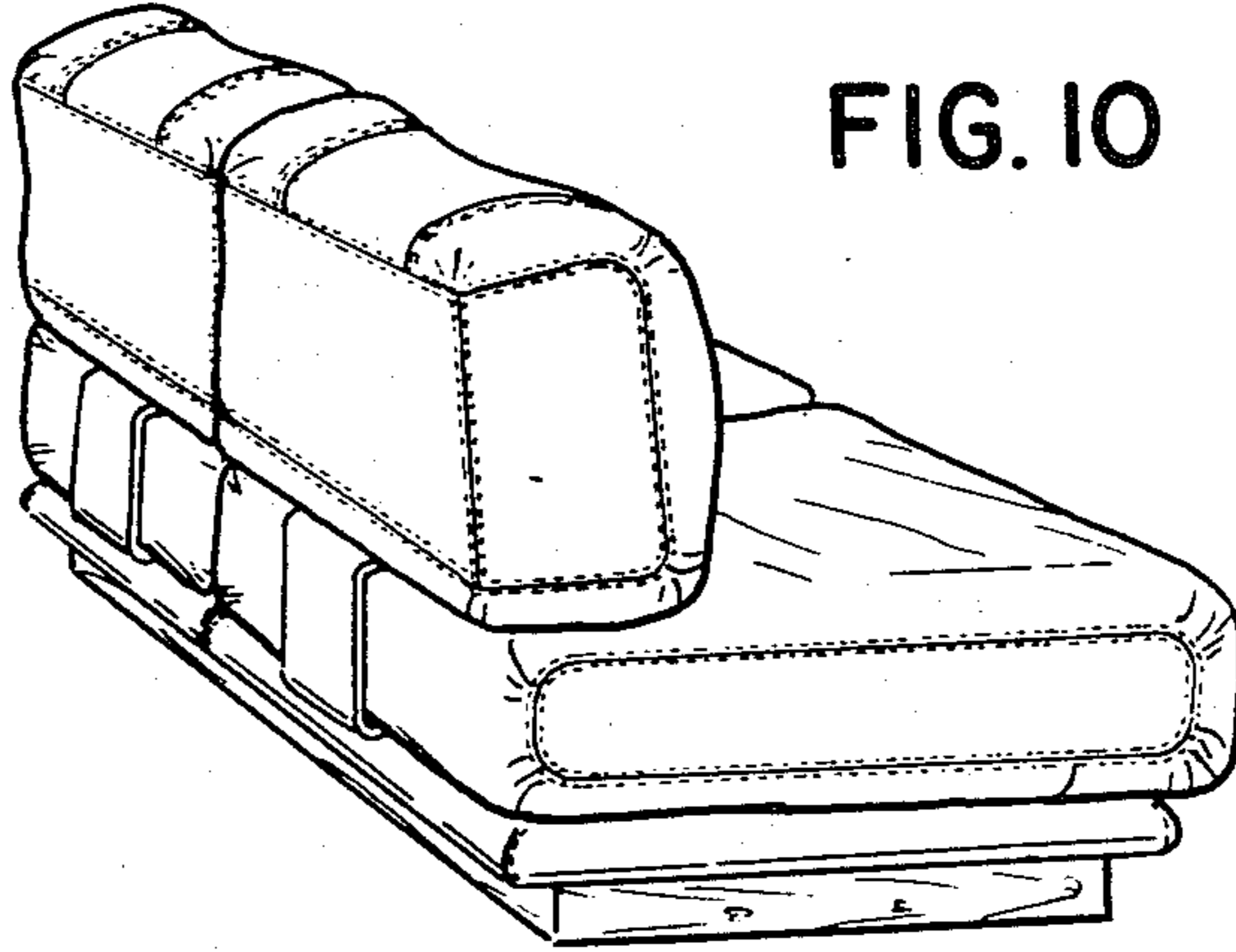

FIG. 11

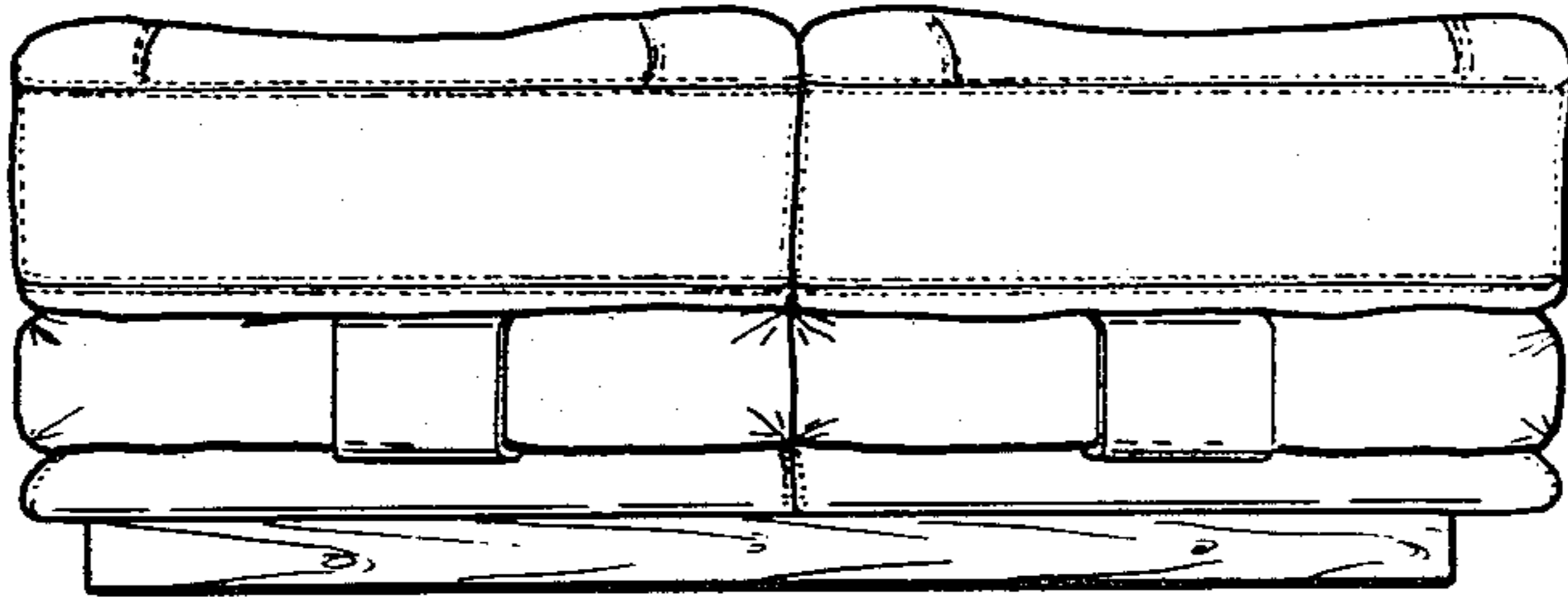

FIG. 12

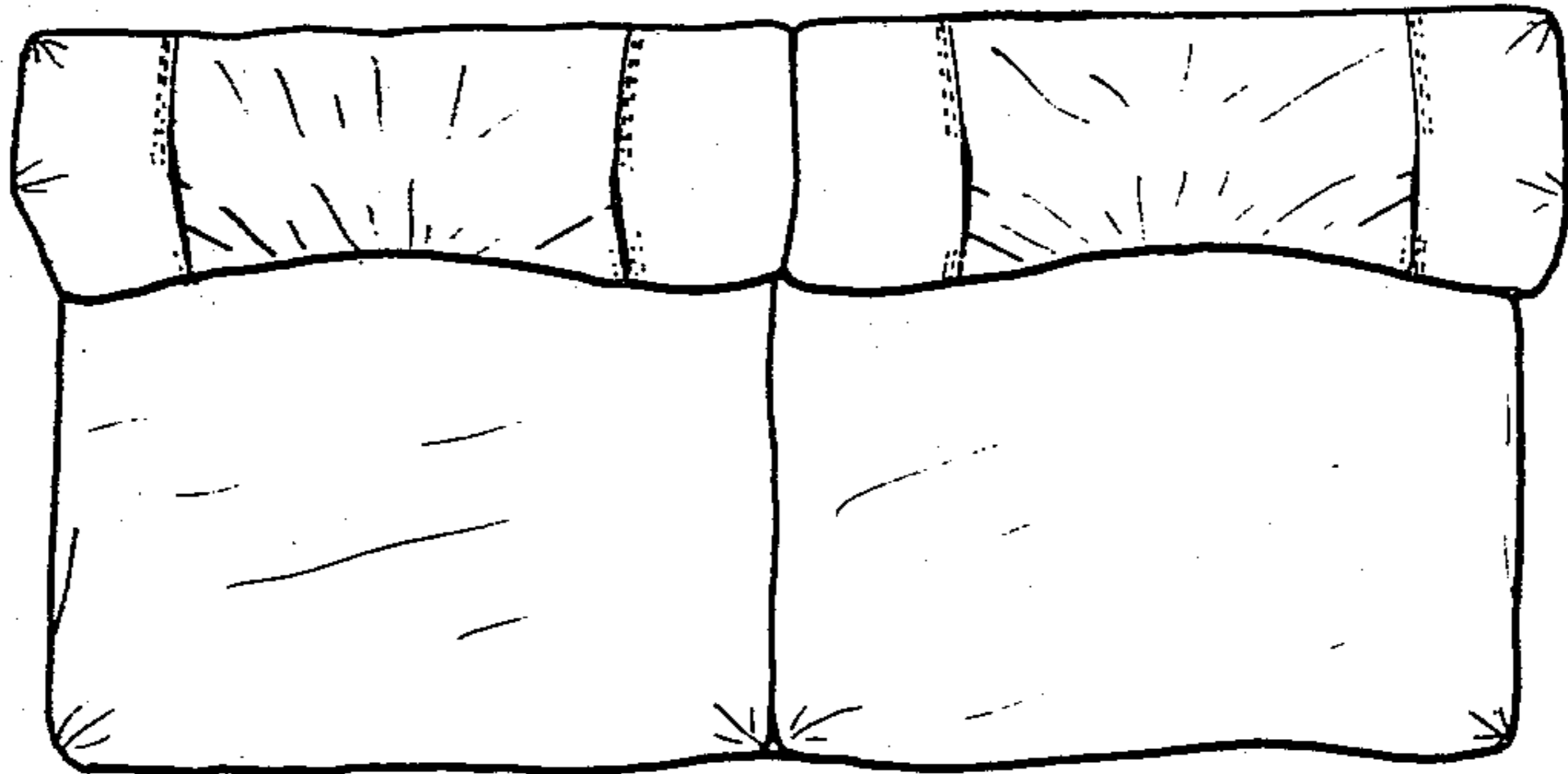

FIG. 13

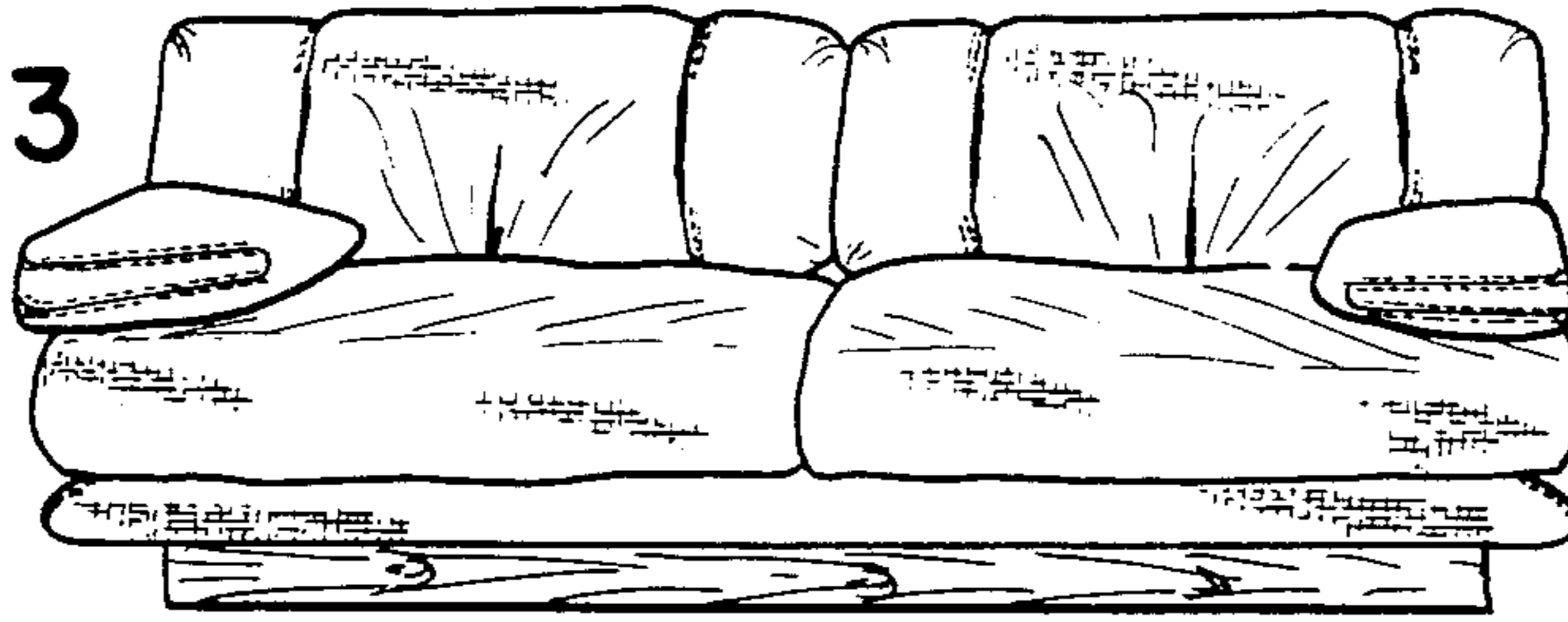

FIG. 14

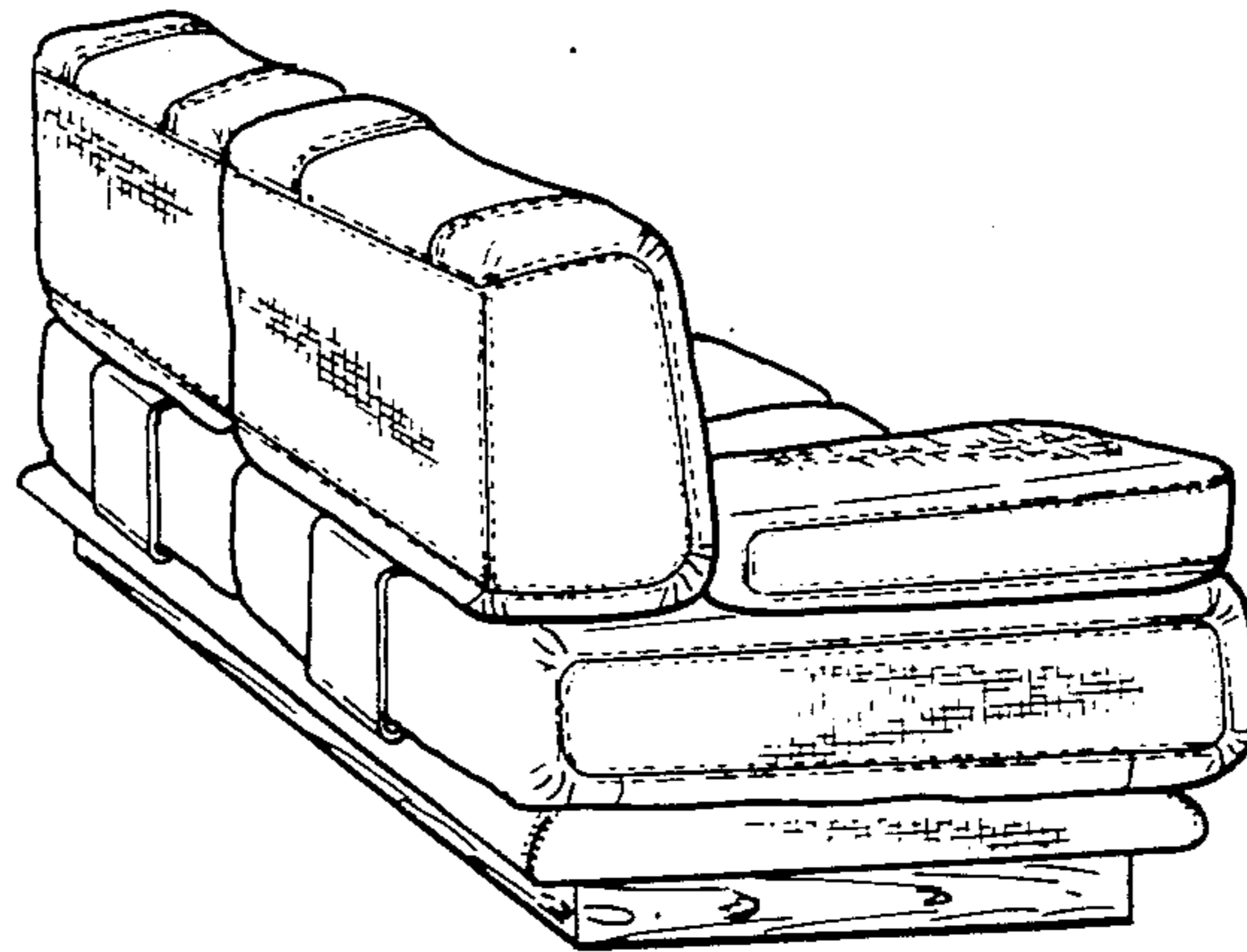

FIG. 15

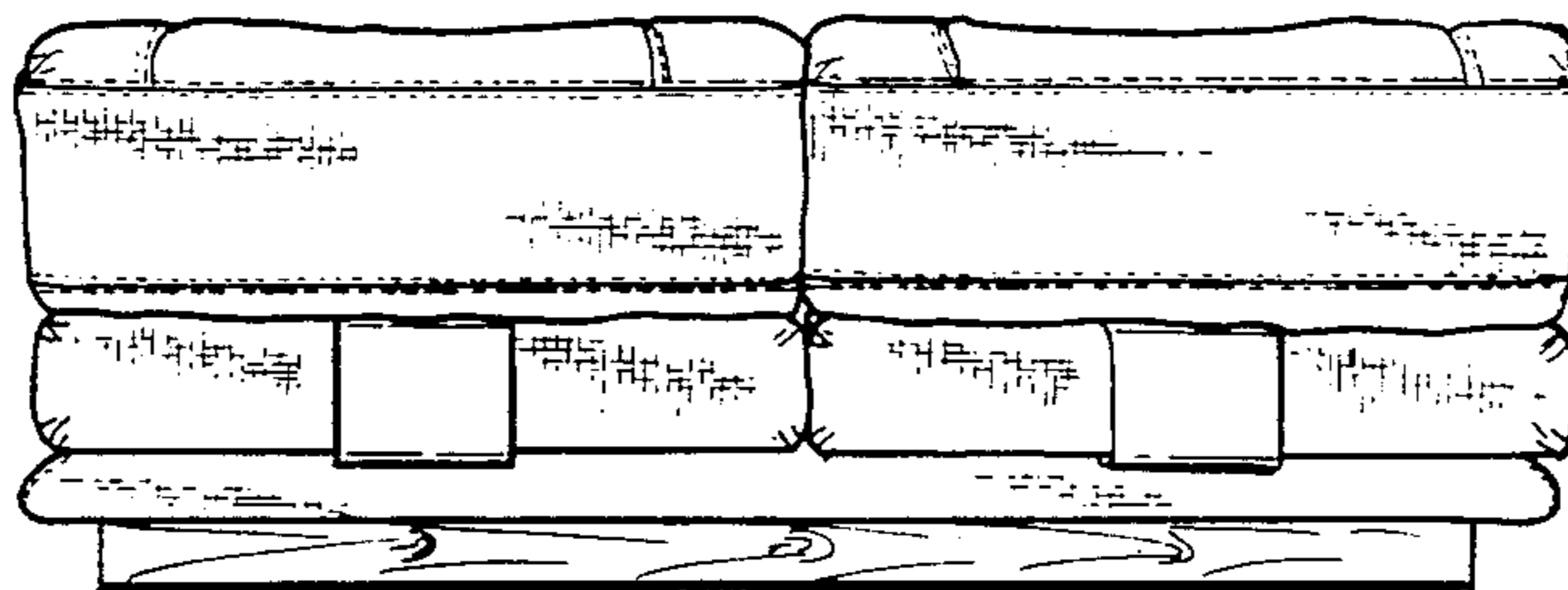
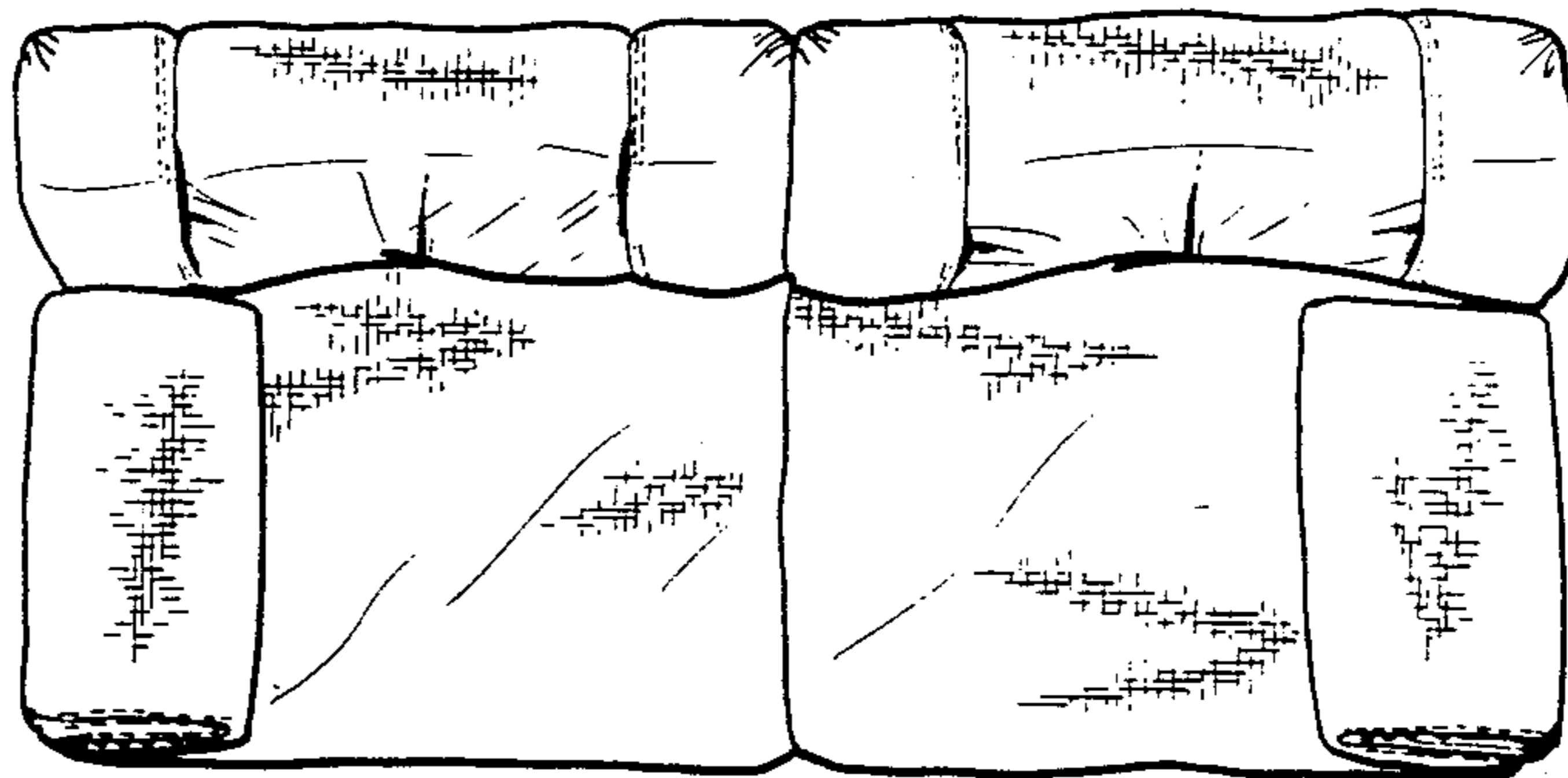

FIG. 16



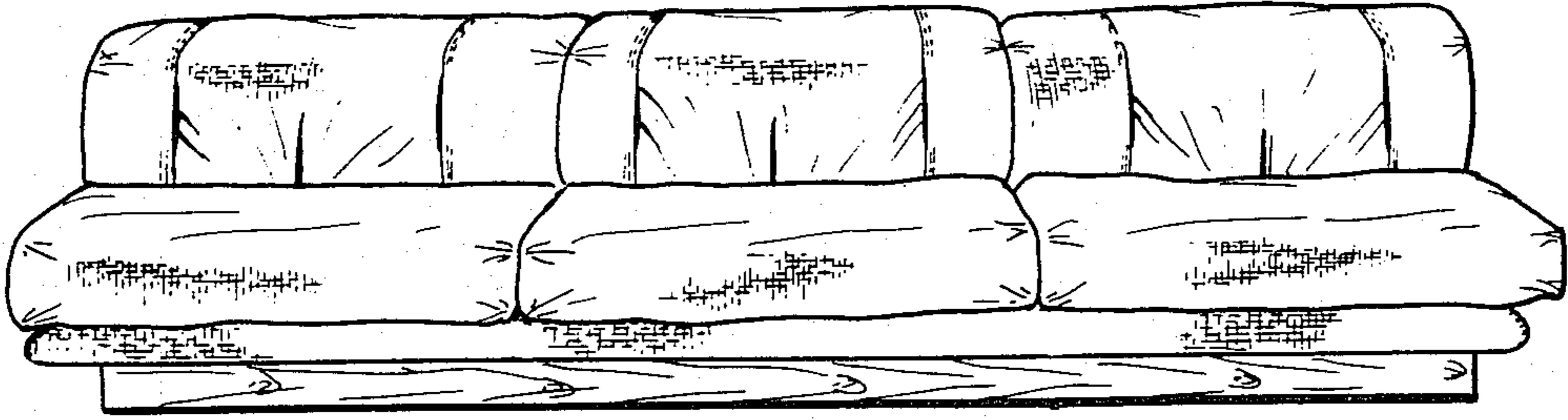

FIG. 17

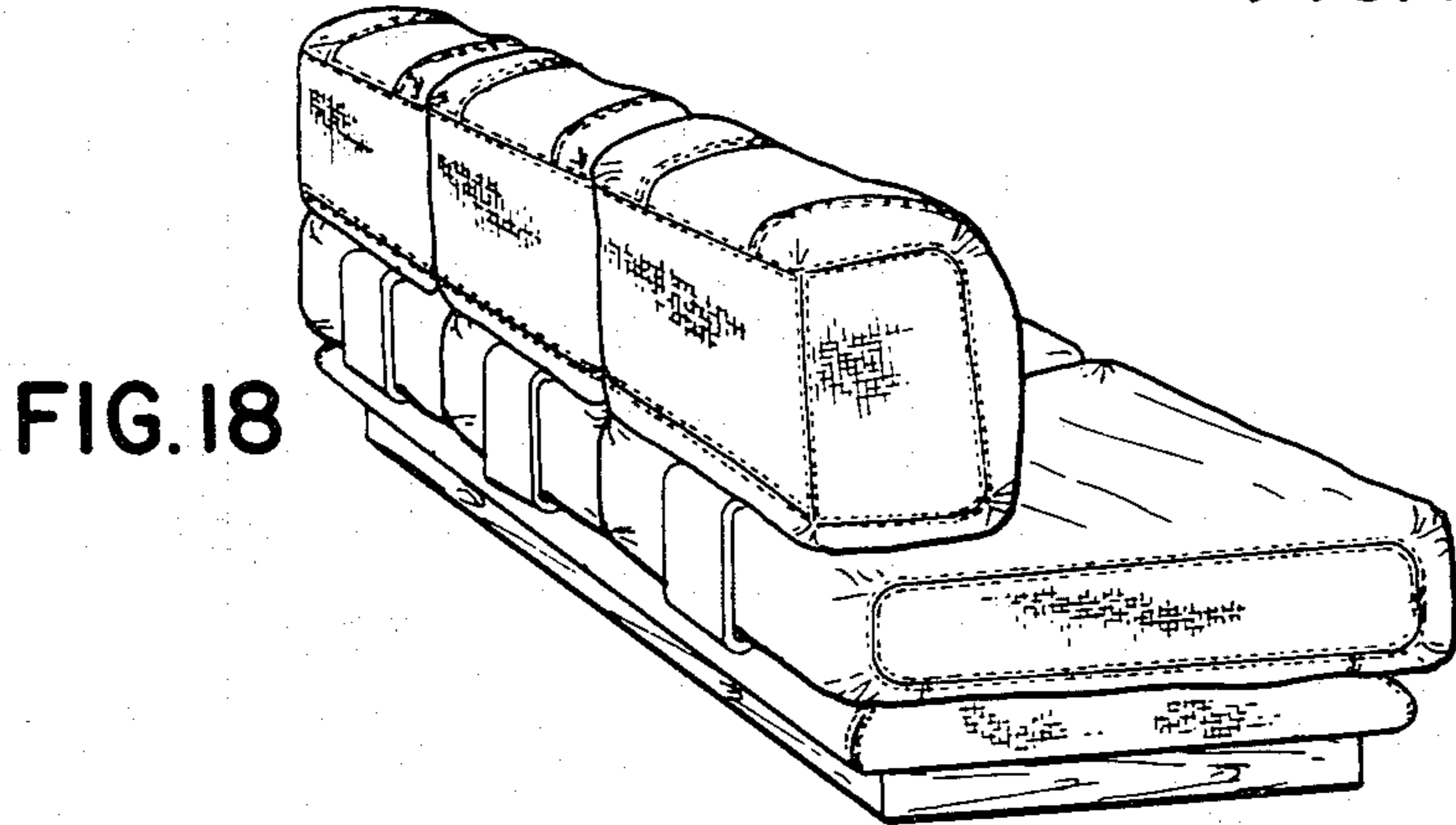

FIG. 18

FIG. 19

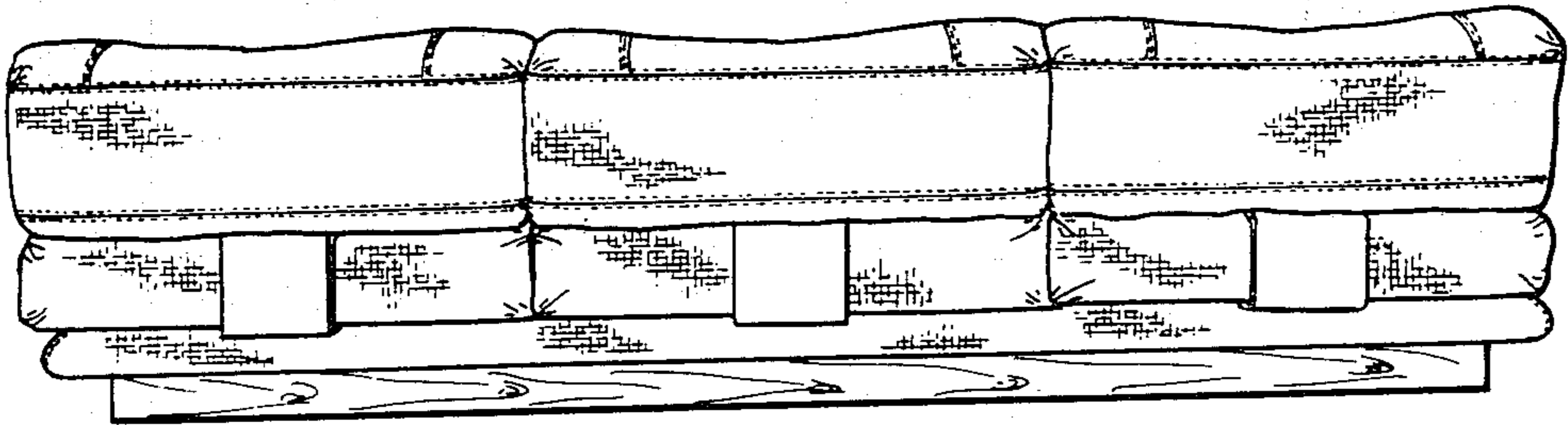
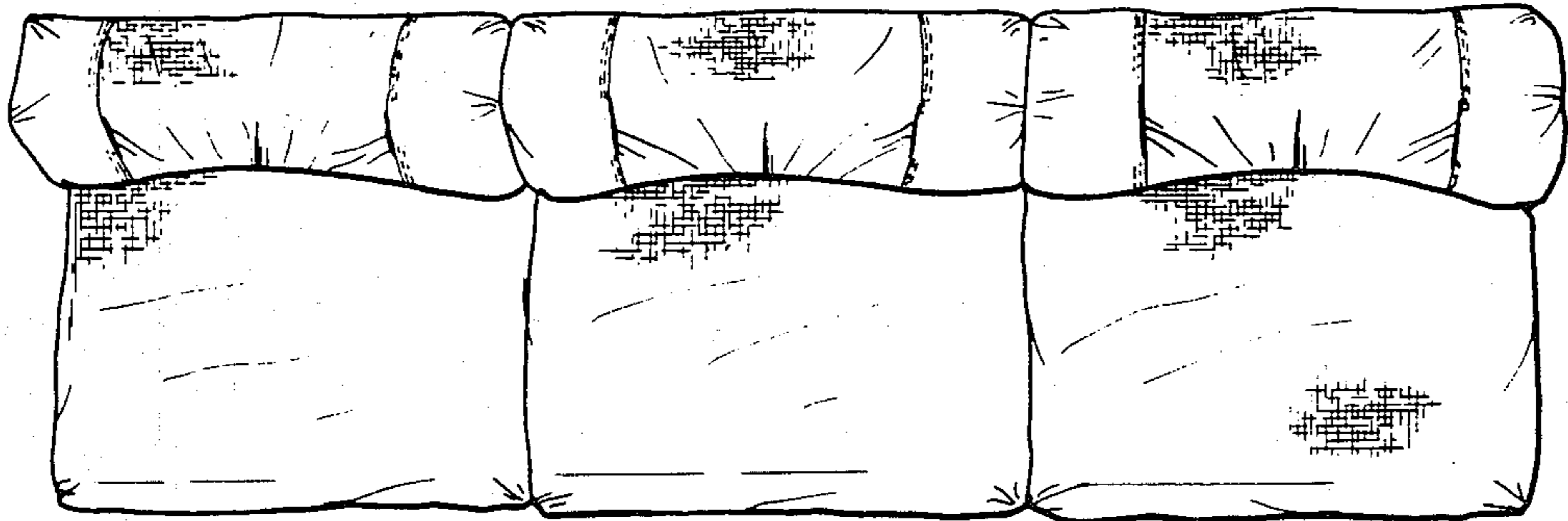

FIG. 20



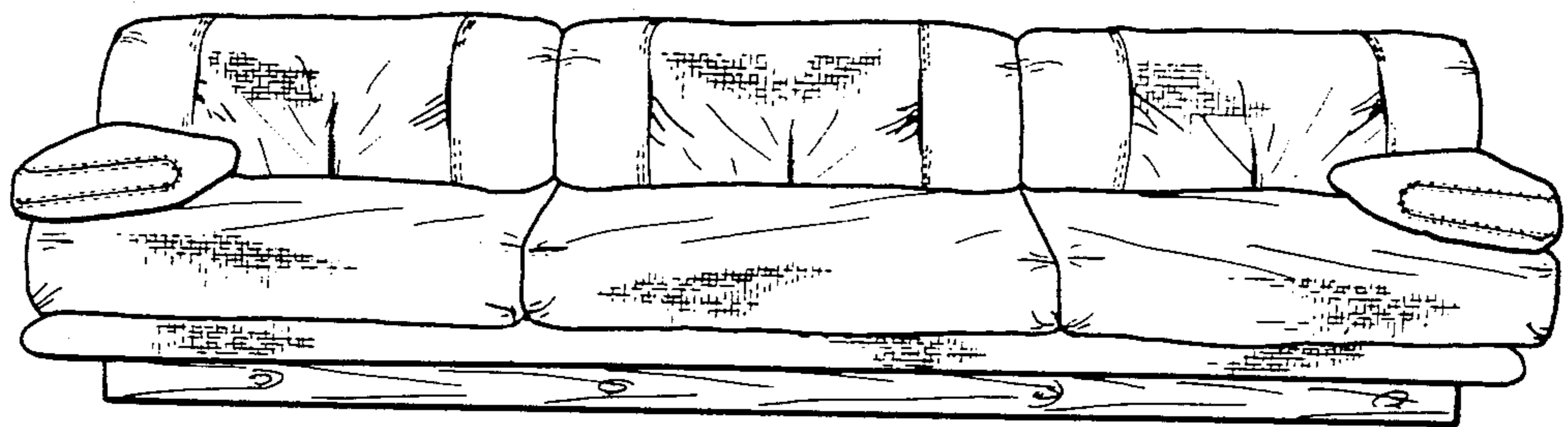

FIG. 21

FIG. 22

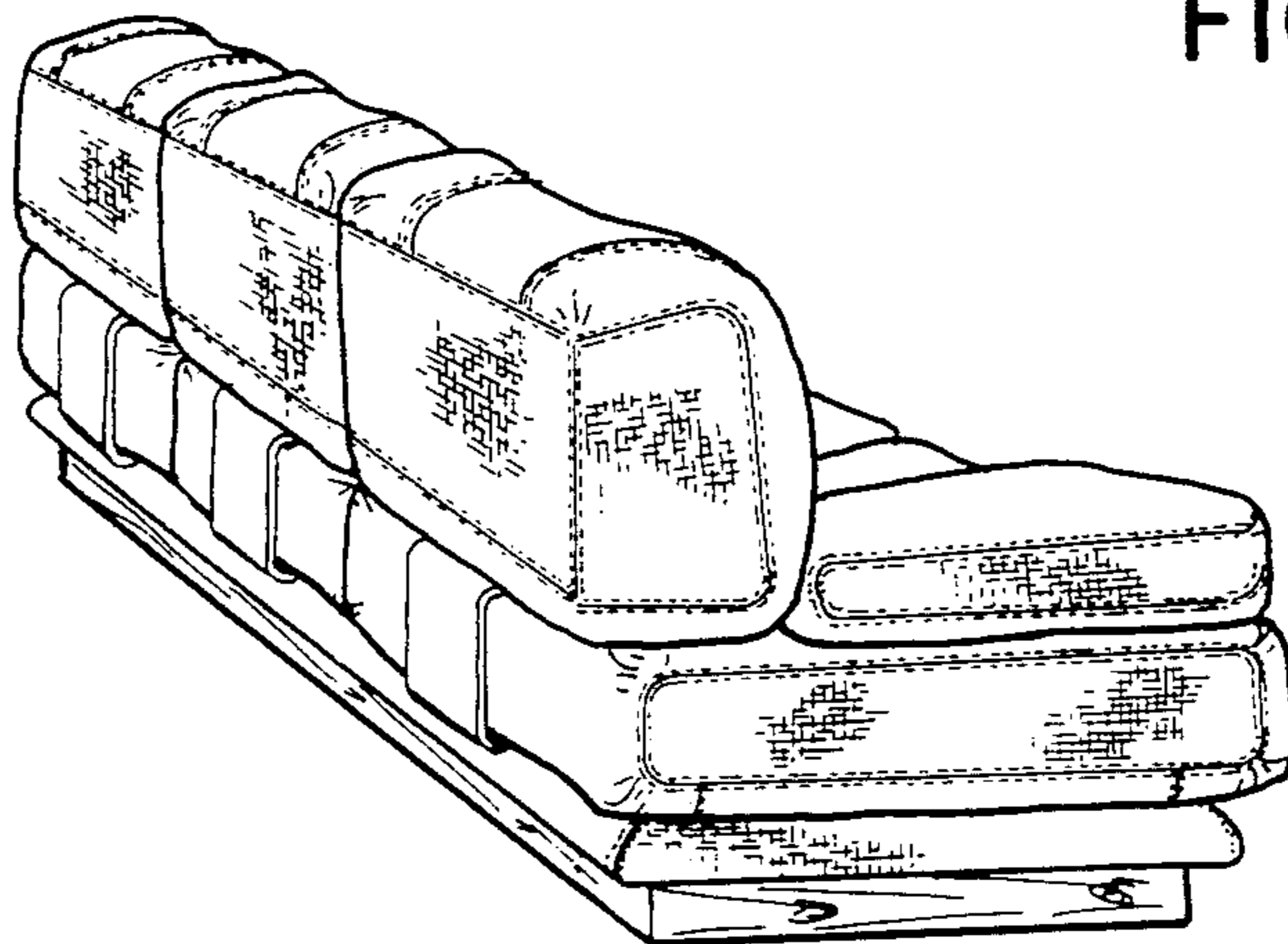

FIG. 23

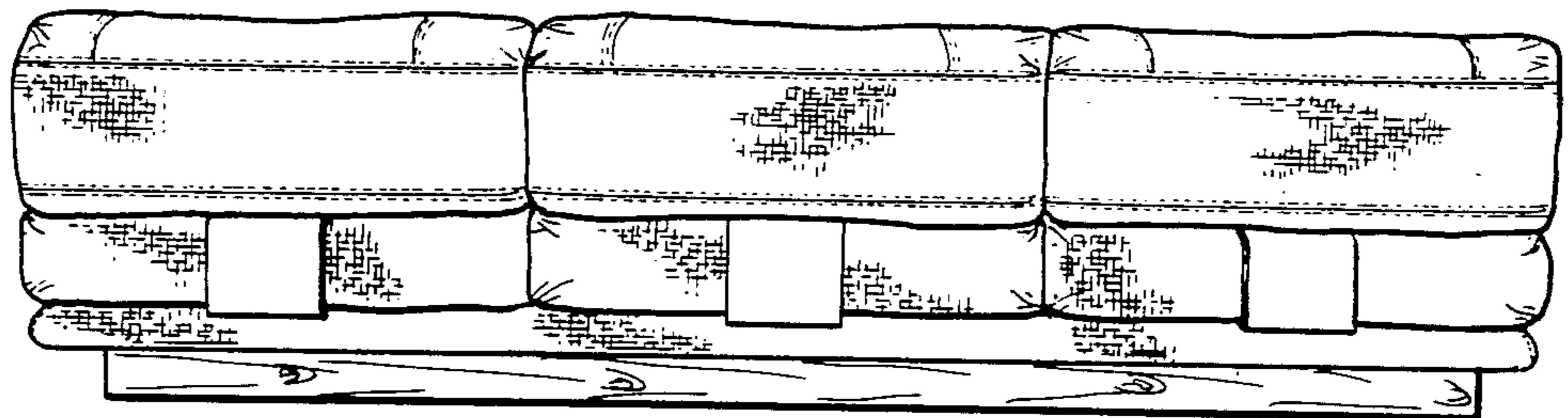

FIG. 24

