

[54] BOOK HOLDER

[76] Inventor: Robert L. Jensen, 10000 NE. 37th St., Vancouver, Wash. 98662

[**] Term: 14 Years

[21] Appl. No.: 404,624

[22] Filed: Aug. 2, 1982

[52] U.S. Cl. D6/419; D19/91

[58] Field of Search D6/180, 181, 184, 185, D6/138; 211/42, 43, 45, 13; 248/441 R, 441 A, 441 B, 441 C, 460, 454, 455, 457; D19/90, 91, 92

[56] References Cited

U.S. PATENT DOCUMENTS

D. 128,172	7/1941	Morgan	D6/184
D. 183,271	7/1958	Schuttler et al.	D6/184
D. 248,523	7/1978	Goldstein	D6/184
1,767,950	6/1930	Westbrook	248/454
2,041,017	5/1936	Pennington	D6/184 X

3,001,800	9/1961	Pearce	211/42 X
3,952,989	4/1976	Bannister-Hatcher	248/454 X

Primary Examiner—Carmen H. Vales
Attorney, Agent, or Firm—Klarquist, Sparkman, Campbell, Leigh & Winston

[57] CLAIM

The ornamental design for a book holder, as shown and described.

DESCRIPTION

FIG. 1 is a rear perspective view of a book holder showing my new design;
FIG. 2 is a top plan view thereof;
FIG. 3 is a bottom plan view thereof;
FIG. 4 is a right side elevational view thereof;
FIG. 5 is a left side elevational view thereof;
FIG. 6 is a front elevational view thereof; and
FIG. 7 is a rear elevational view thereof.
FIGS. 2-7 have been drawn at a reduced scale for convenience of illustration.

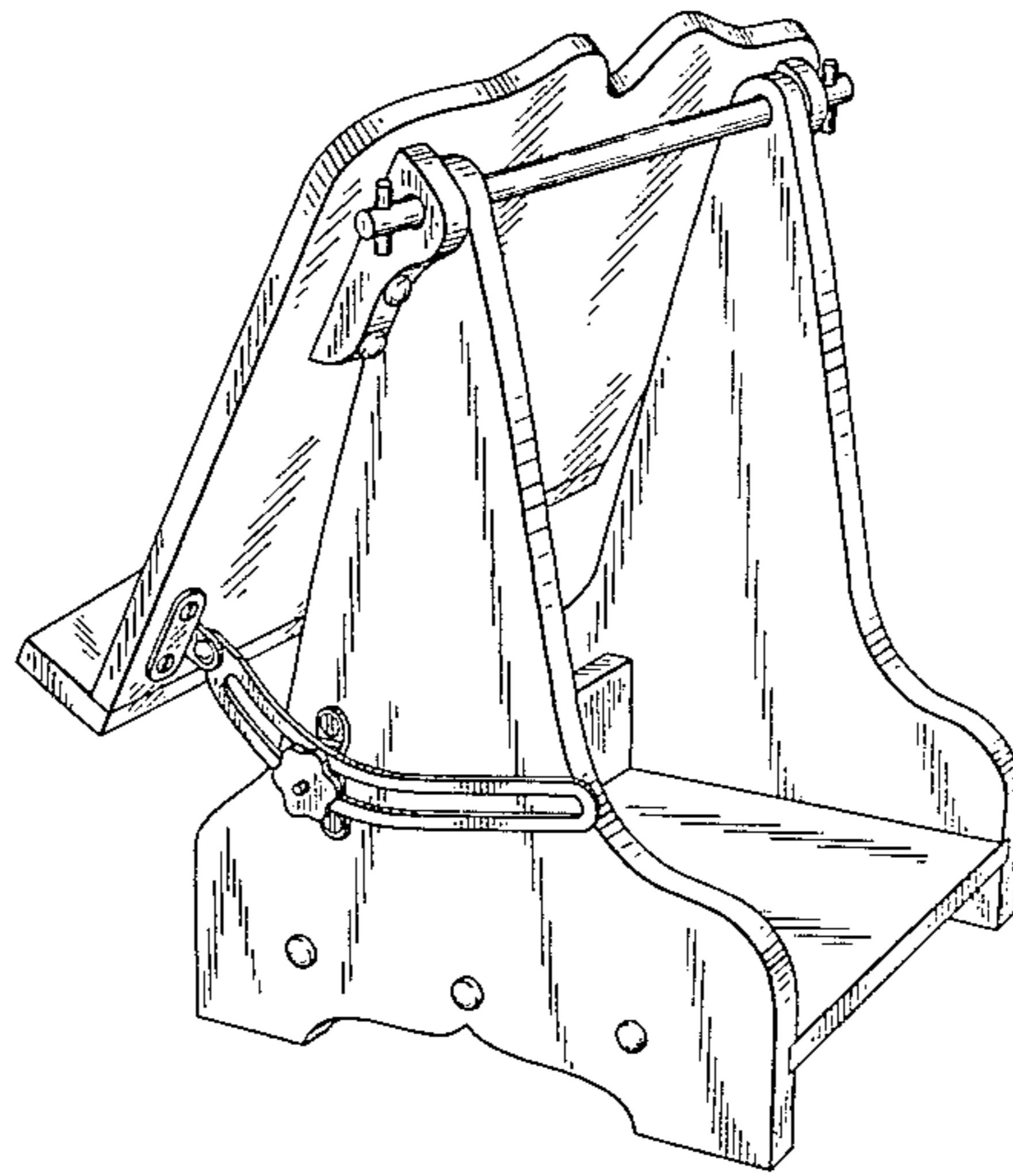

FIG. 1

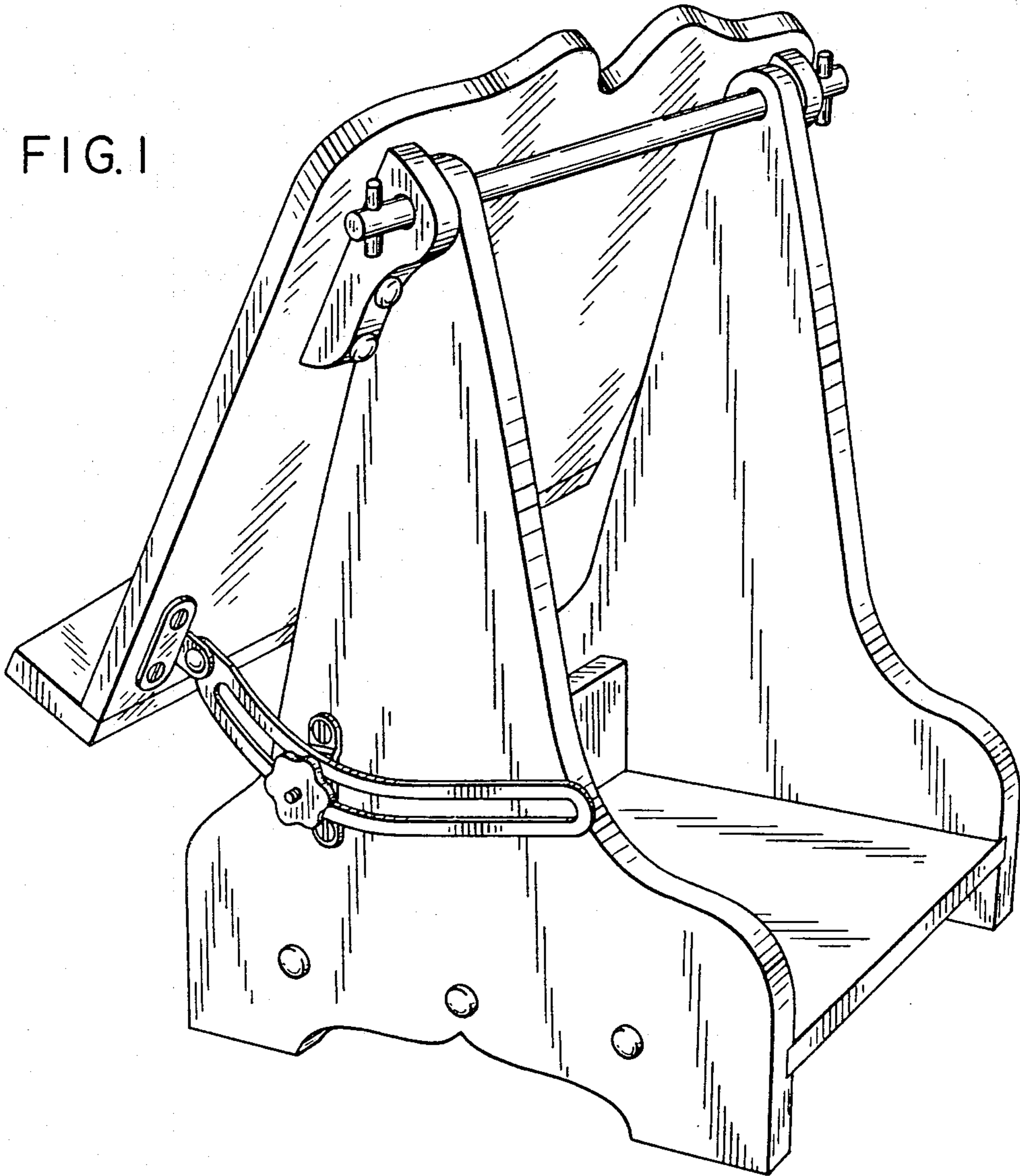

FIG. 2

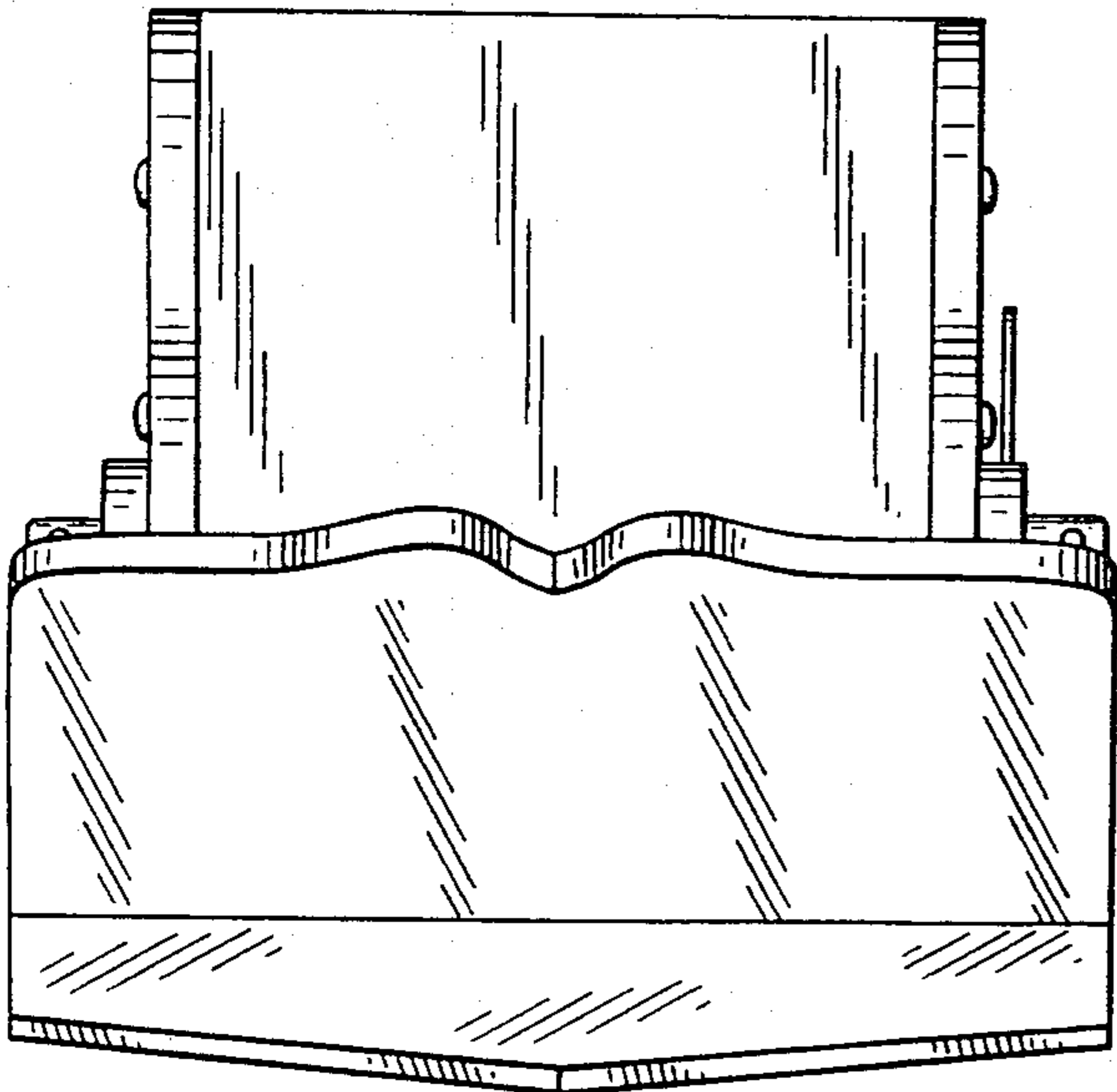

FIG. 3

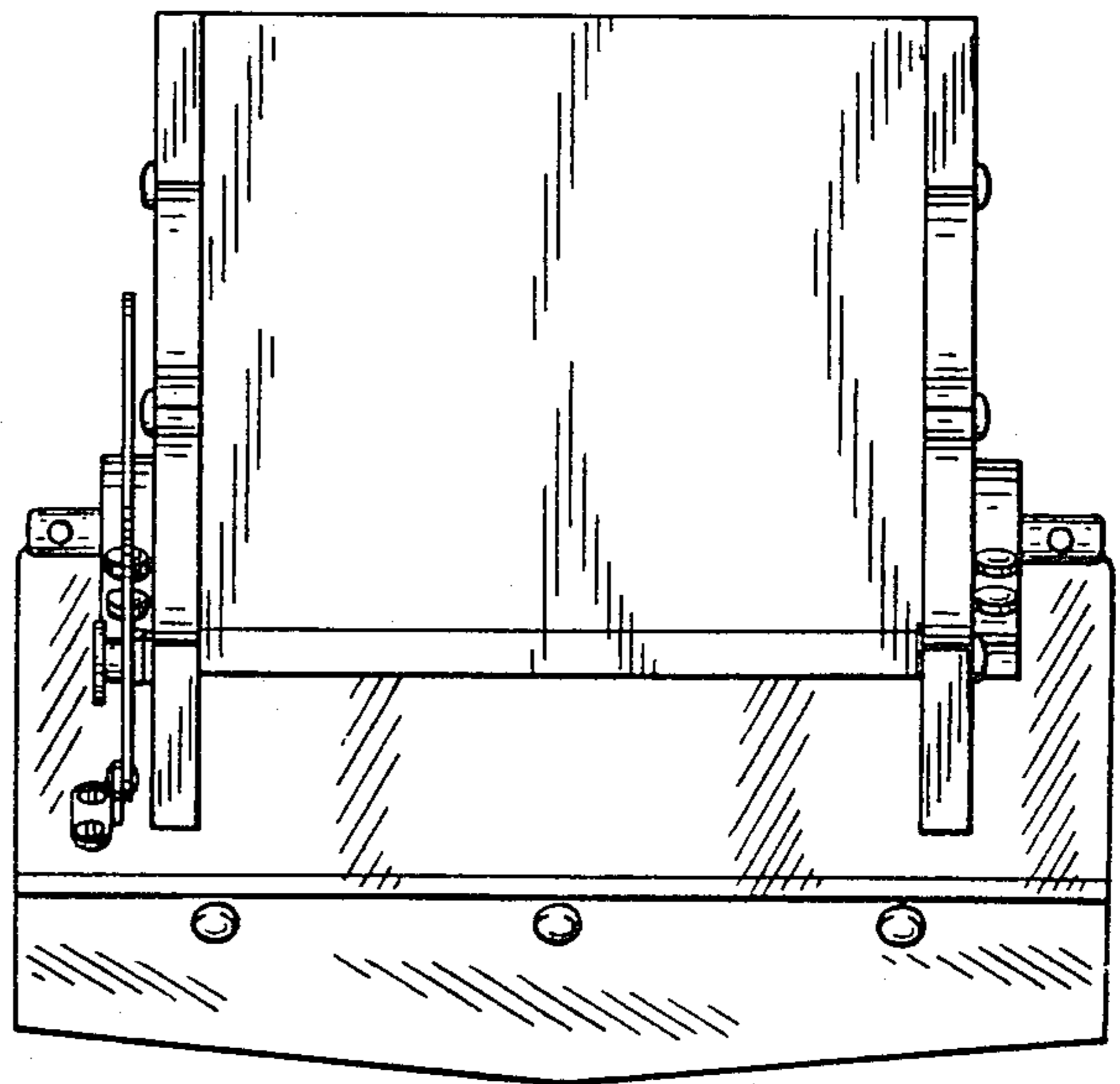

FIG. 4

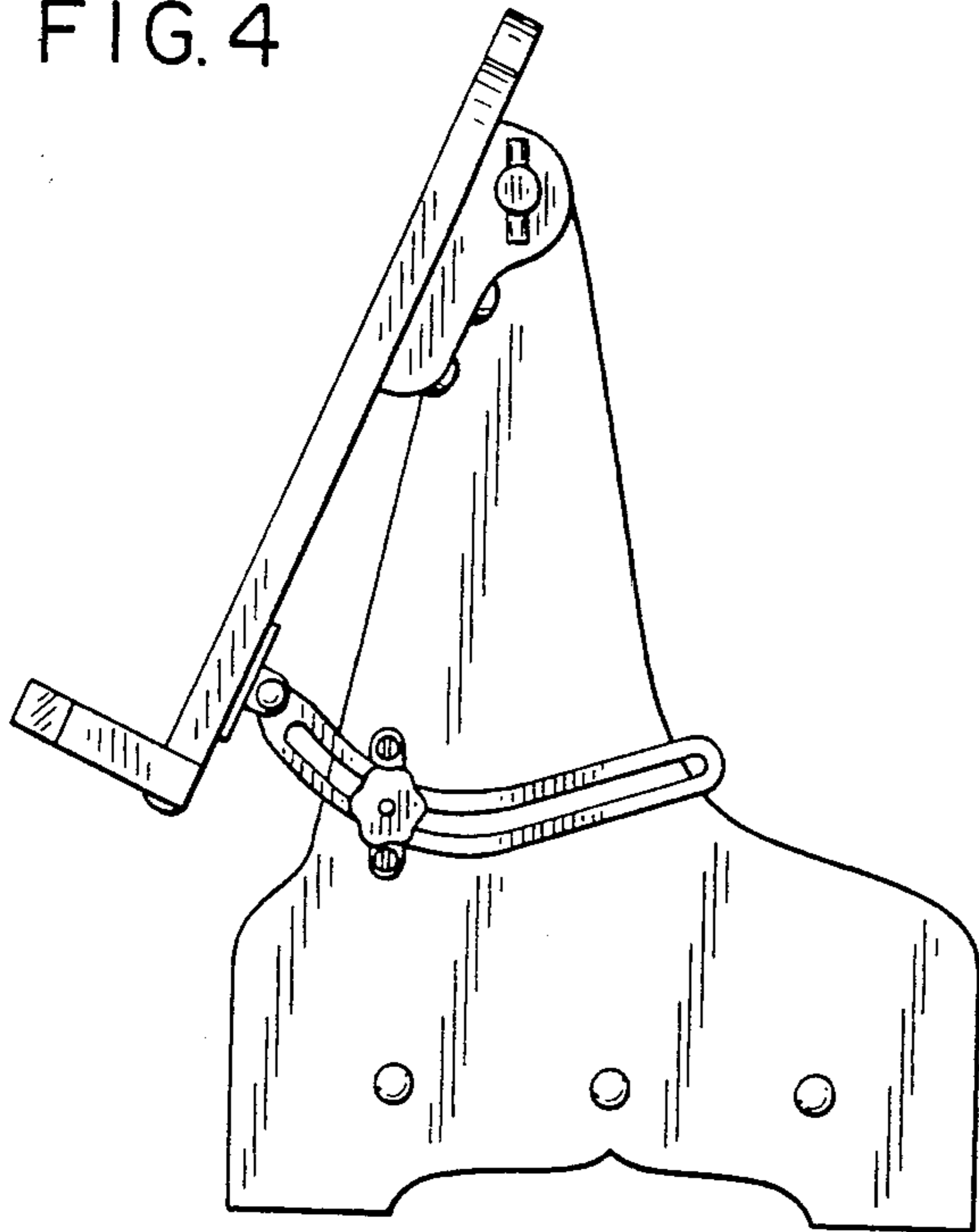

FIG. 5

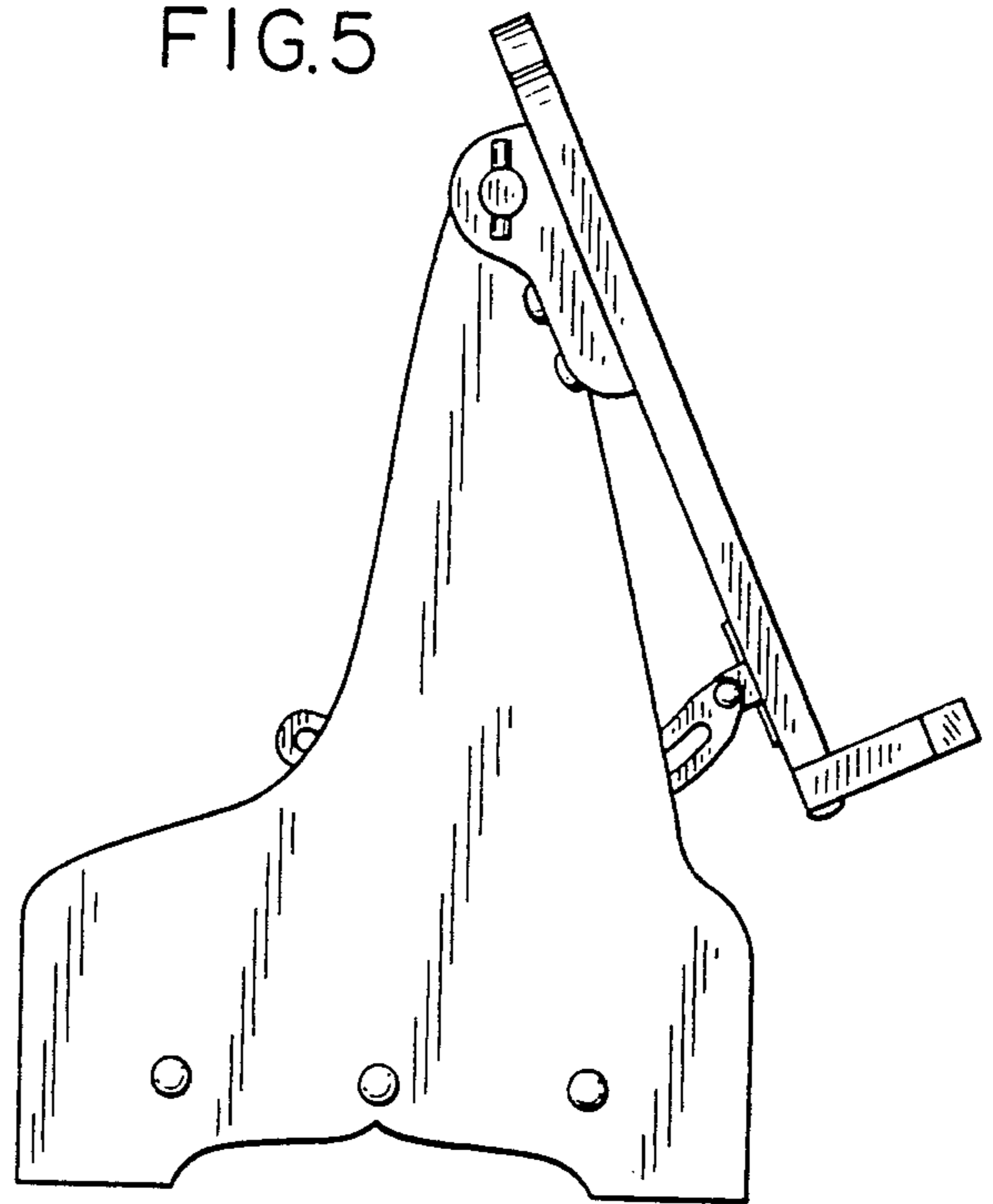

FIG. 6

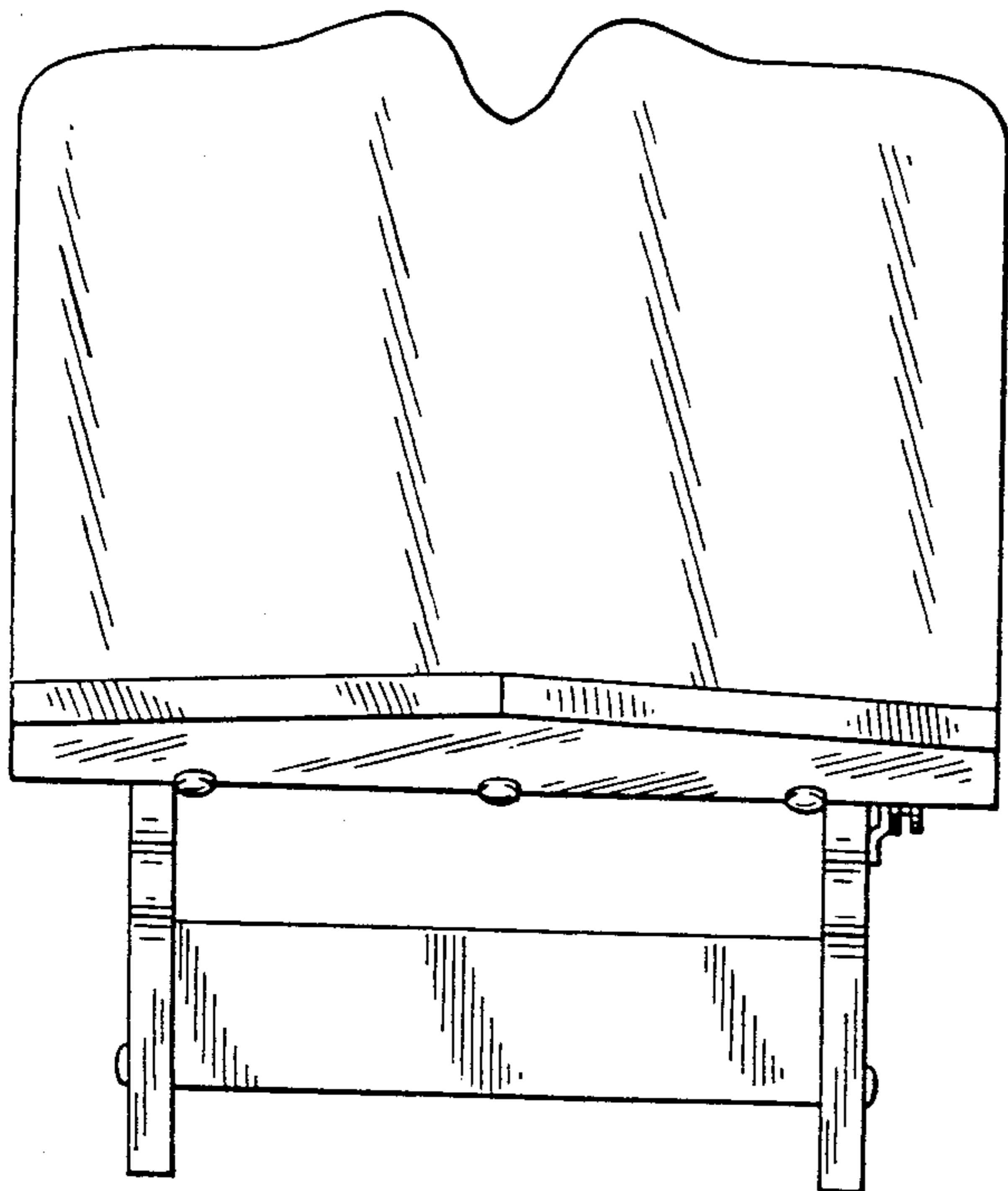

FIG. 7

