

United States Patent [19]

Morawski

[11] Patent Number: **Des. 278,525**

[45] Date of Patent: **** Apr. 23, 1985**

[54] FLOOR MAT FOR A VEHICLE

[76] Inventor: **Janusz Morawski**, P.O. Box 562,
Station "P", Toronto, Ontario,
Canada

[**] Term: **14 Years**

[21] Appl. No.: **256,721**

[22] Filed: **Apr. 23, 1981**

[30] **Foreign Application Priority Data**

Oct. 27, 1980 [CA] Canada 27-10-80-8

Nov. 5, 1980 [CA] Canada 05-11-80-5

[52] U.S. Cl. **D12/203**

[58] Field of Search D6/209; D12/203;
15/215; 296/1 F

[56] **References Cited**

U.S. PATENT DOCUMENTS

D. 171,301 1/1954 Kravitz 15/215 X
D. 178,819 9/1956 Barnes D12/203
3,488,081 1/1970 Nolen 296/1 F

OTHER PUBLICATIONS

"Rubbermaid Specialty Products" Catalog, ©1978, p.
2, top left mat.

Primary Examiner—Jane E. Corrigan

[57] **CLAIM**

The ornamental design for a floor mat for a vehicle, as
shown and described.

DESCRIPTION

FIG. 1 is a front, top and right side perspective view of
a floor mat for a vehicle showing my new design;

FIG. 2 is a top plan view;

FIG. 3 is a right side elevational view;

FIG. 4 is a front elevational view;

FIG. 5 is a rear elevational view; and

FIG. 6 is a bottom plan view.

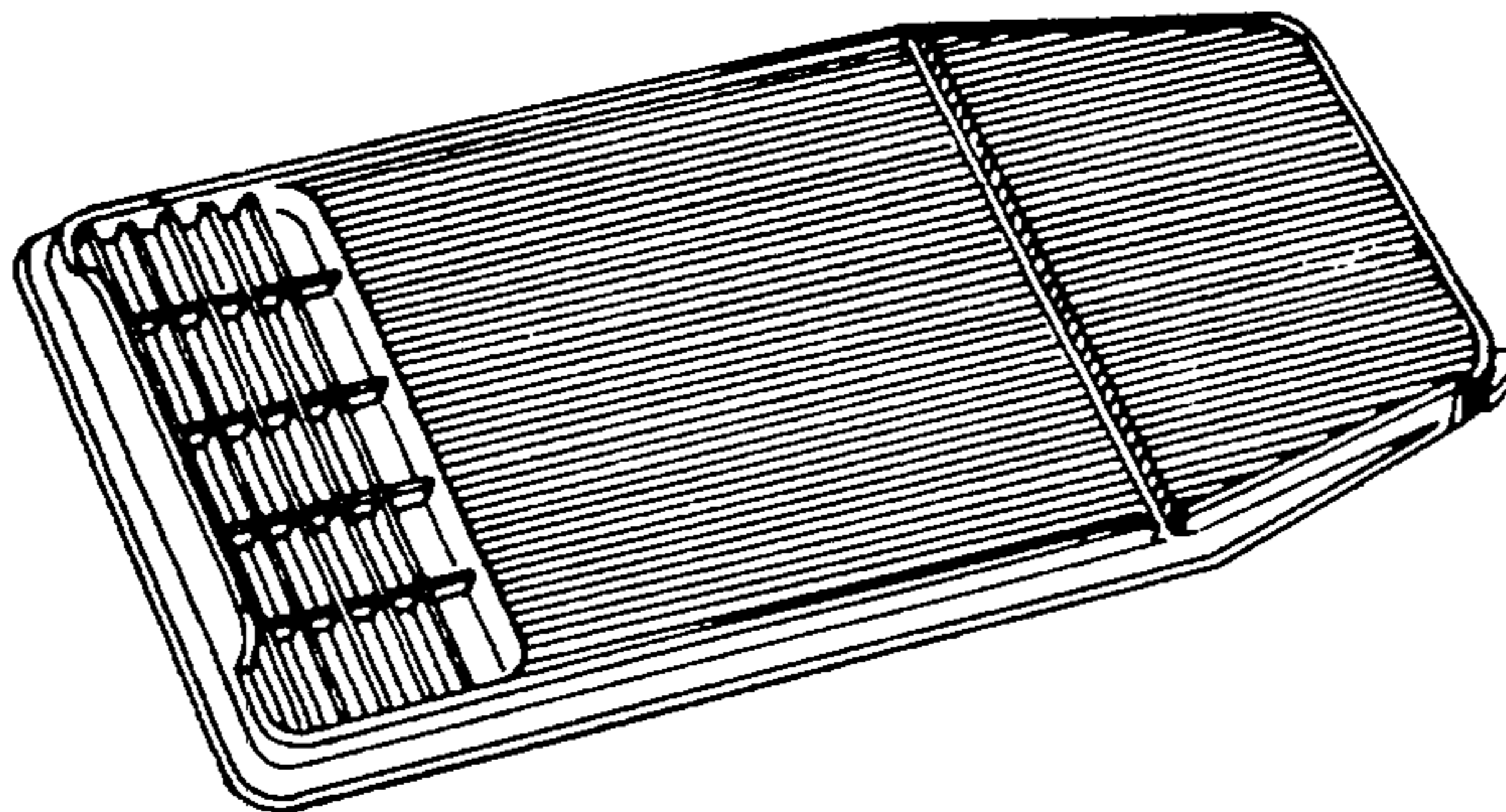

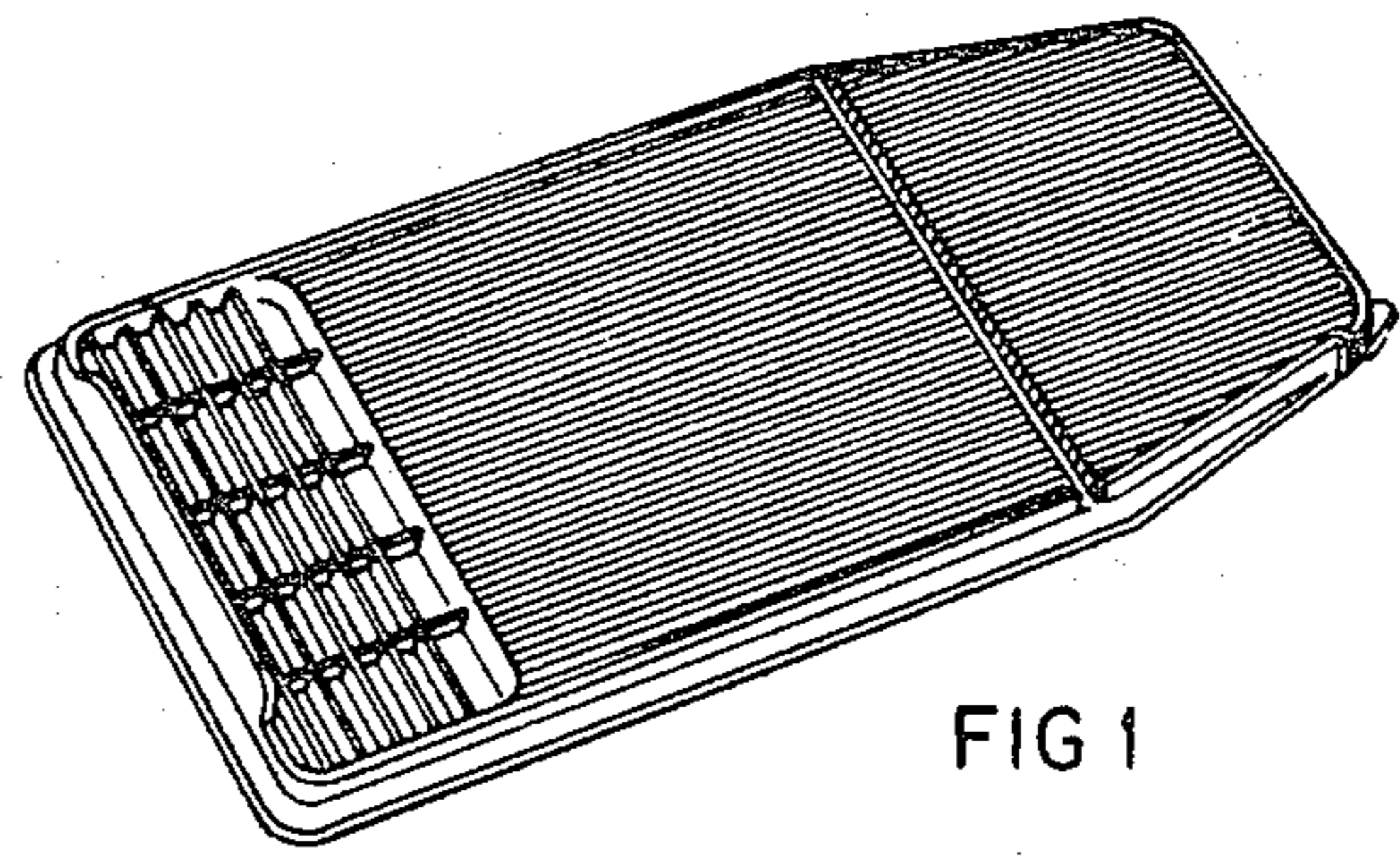

FIG 1

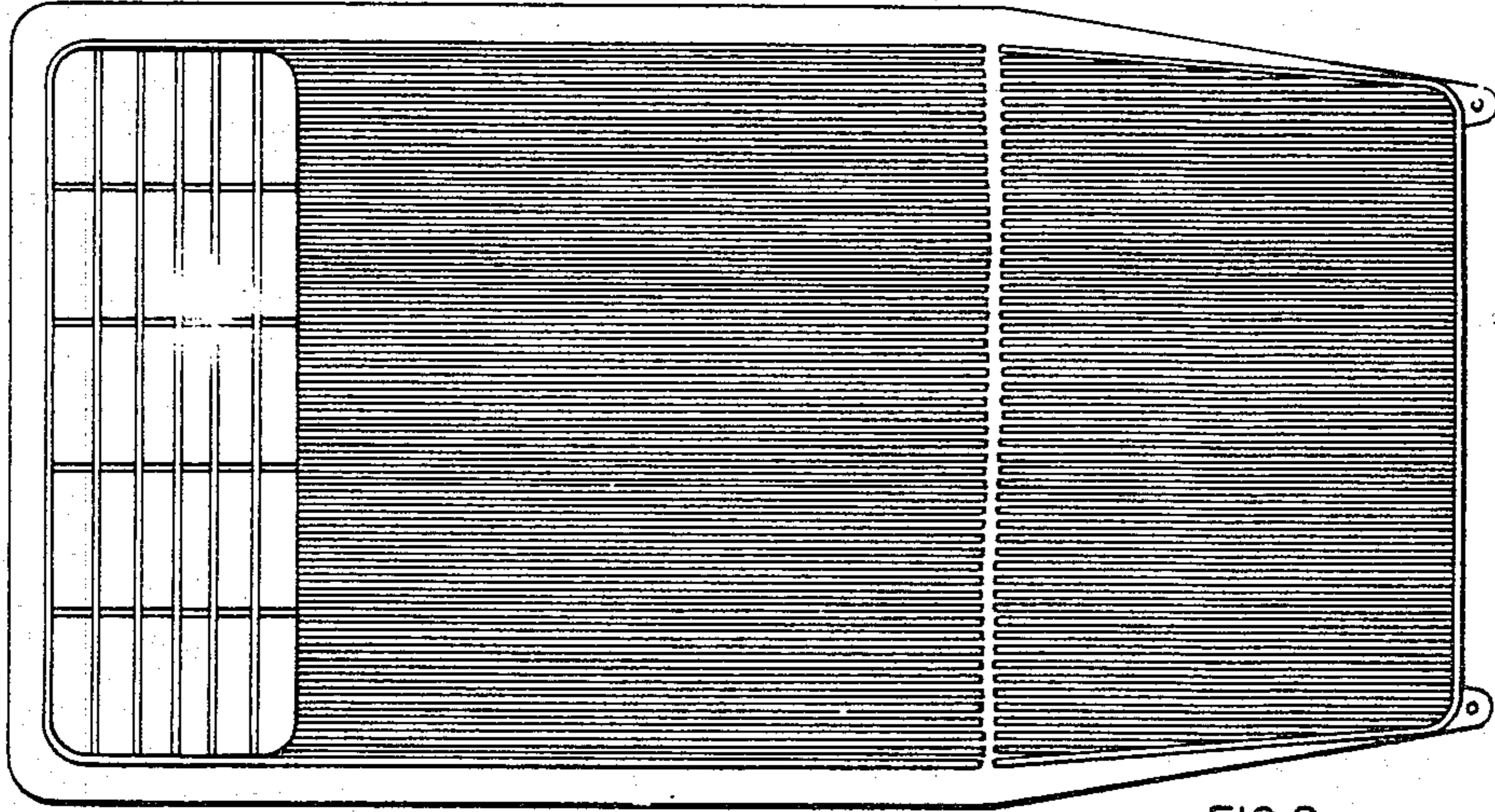

FIG 2

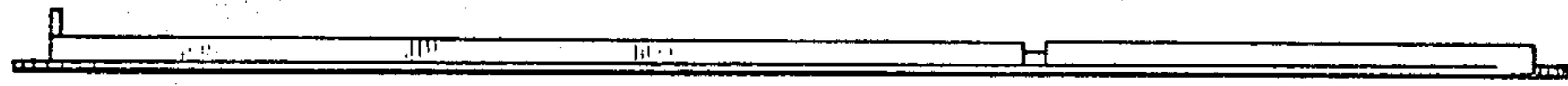

FIG 3

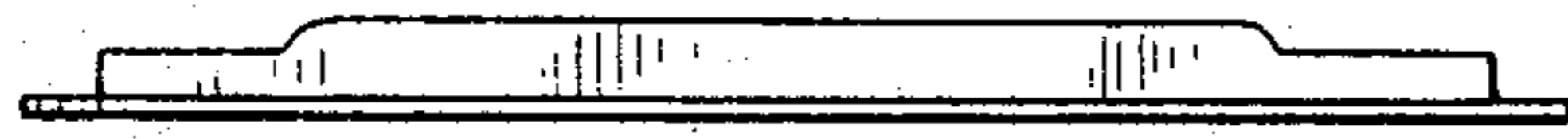

FIG 4

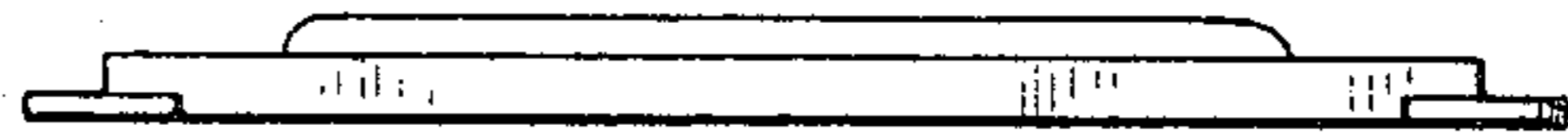

FIG 5

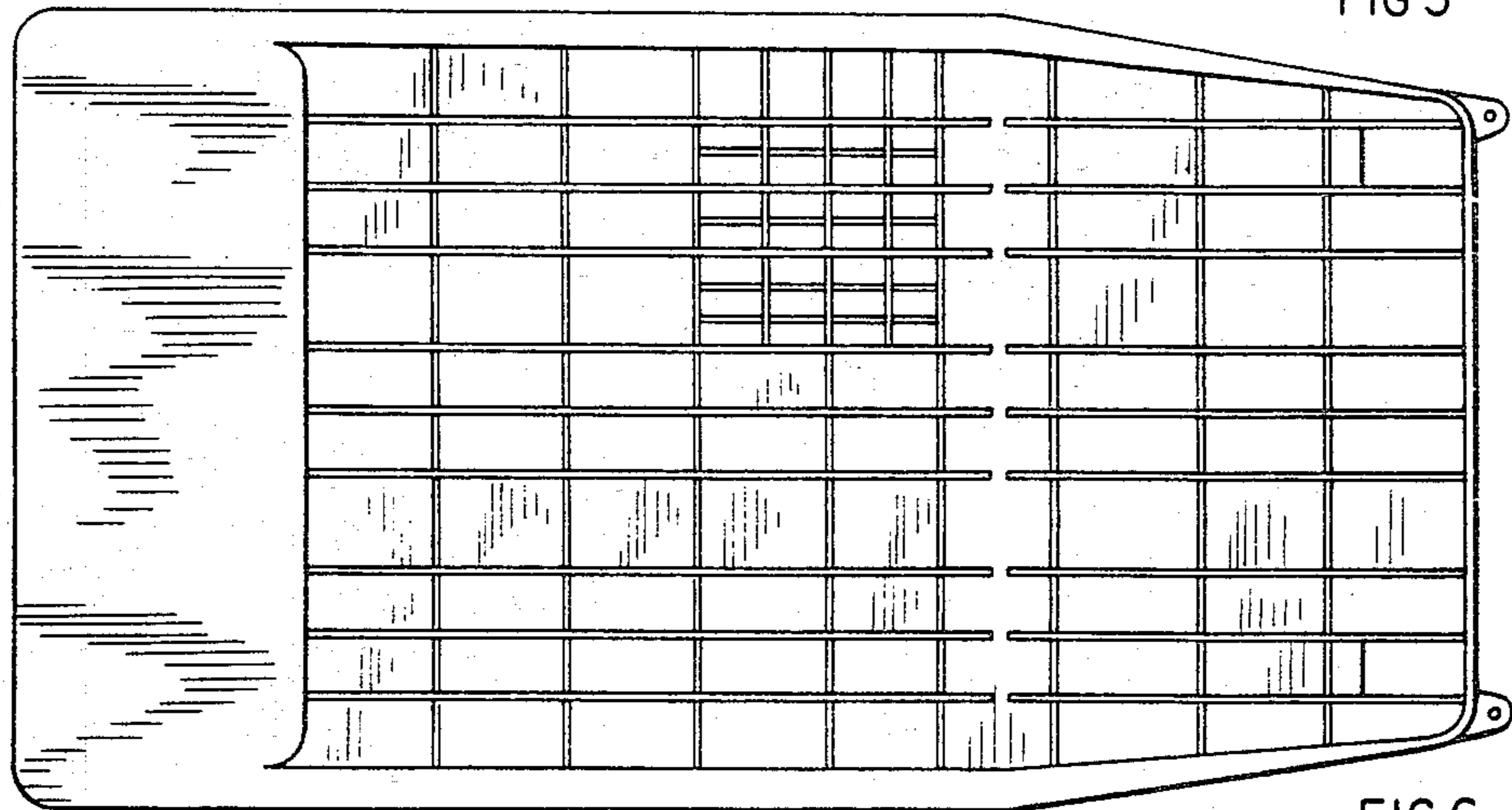

FIG 6