

[54] **EASEL FOR PRONE INDIVIDUAL**

[76] **Inventor: Marcian C. Hausman, R.R. 3,
Tuscola, Ill. 61953**

[**] **Term: 14 Years**

[21] **Appl. No.: 405,710**

[22] **Filed: Aug. 4, 1982**

[52] **U.S. Cl. D6/310**

[58] **Field of Search D6/180, 18, 155, 156,
D6/184; 248/441 R, 451, 452, 454, 460**

[56] **References Cited**

U.S. PATENT DOCUMENTS

- D. 255,193 6/1980 Heitz D6/18 X
- D. 264,412 5/1982 Vega D6/180
- D. 272,025 1/1984 Goutchat D6/180
- 4,378,102 3/1983 Portis, Jr. et al. D6/180 X

Primary Examiner—Bruce W. Dunkins
Attorney, Agent, or Firm—Wood, Dalton, Phillips,
Mason & Rowe

[57] **CLAIM**

The ornamental design for the easel for prone individual, as shown and described.

DESCRIPTION

FIG. 1 is a left front perspective view of the easel for prone individual showing my new design;
FIG. 2 is a front elevation view thereof;
FIG. 3 is a rear elevation view thereof;
FIG. 4 is a left side elevation view thereof;
FIG. 5 is a top view thereof taken along 5—5 of FIG. 4;
FIG. 6 is a bottom view thereof taken along line 6—6 of FIG. 4;
FIG. 7 is a right side elevation view thereof.

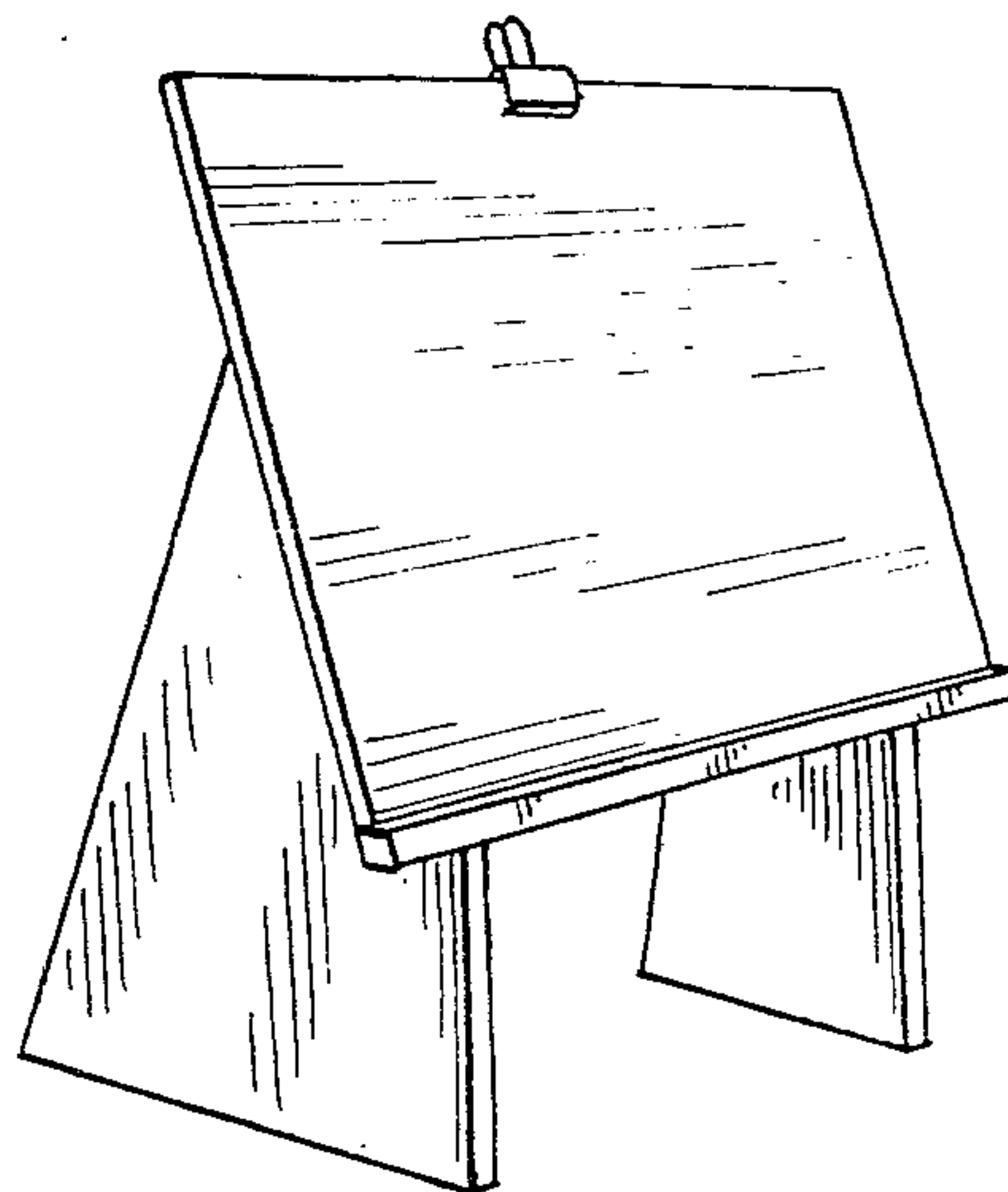

FIG. 1

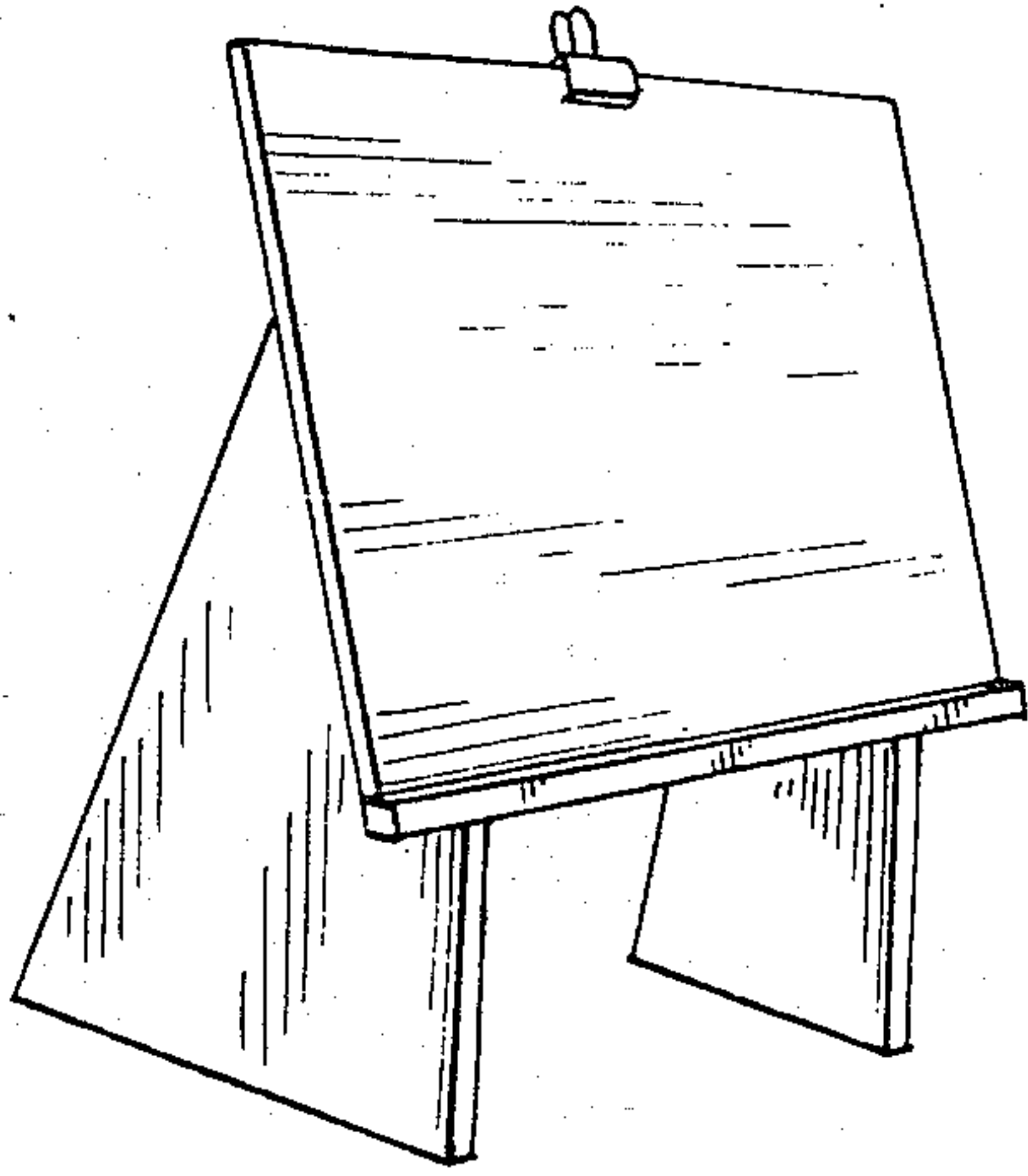

FIG. 2

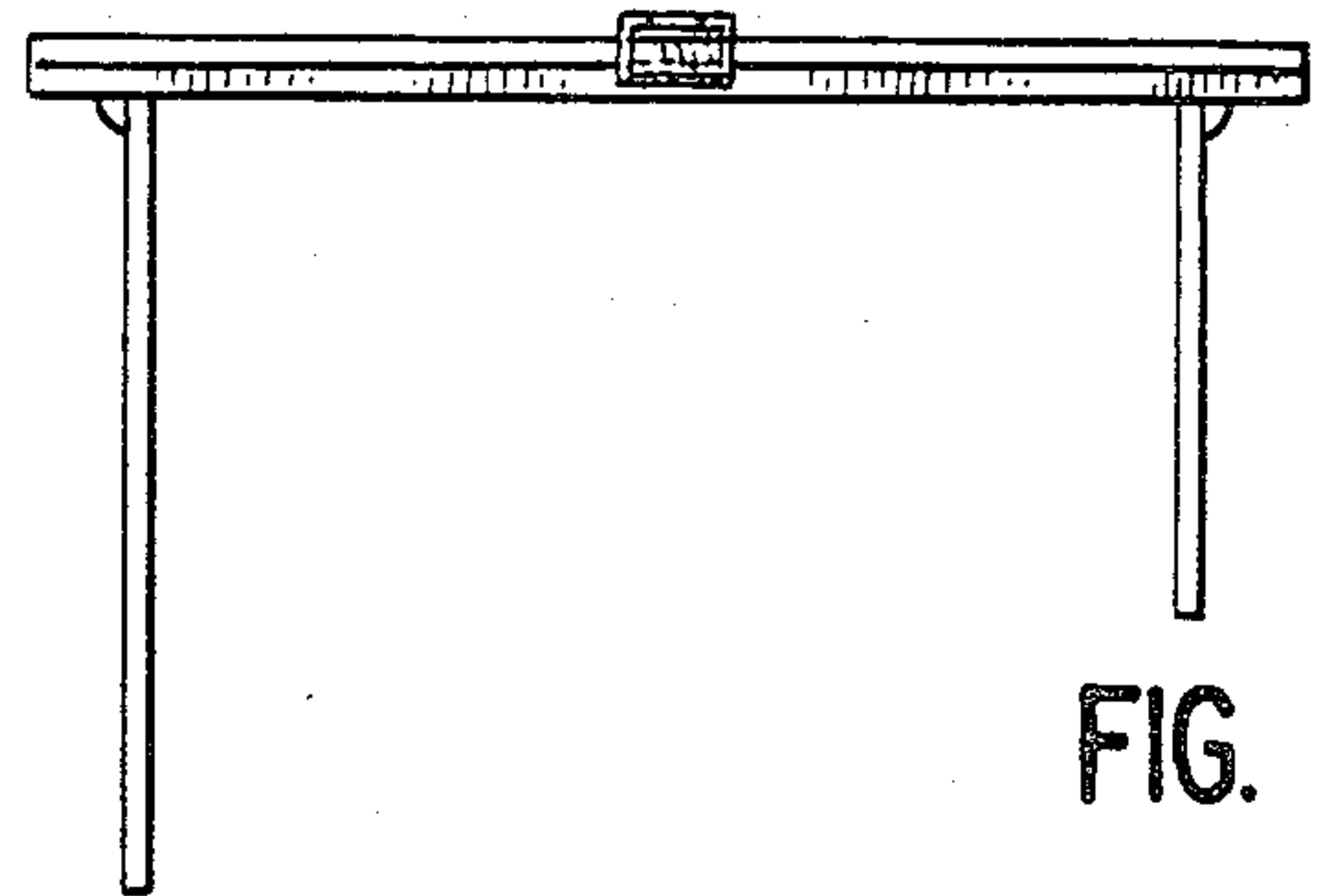
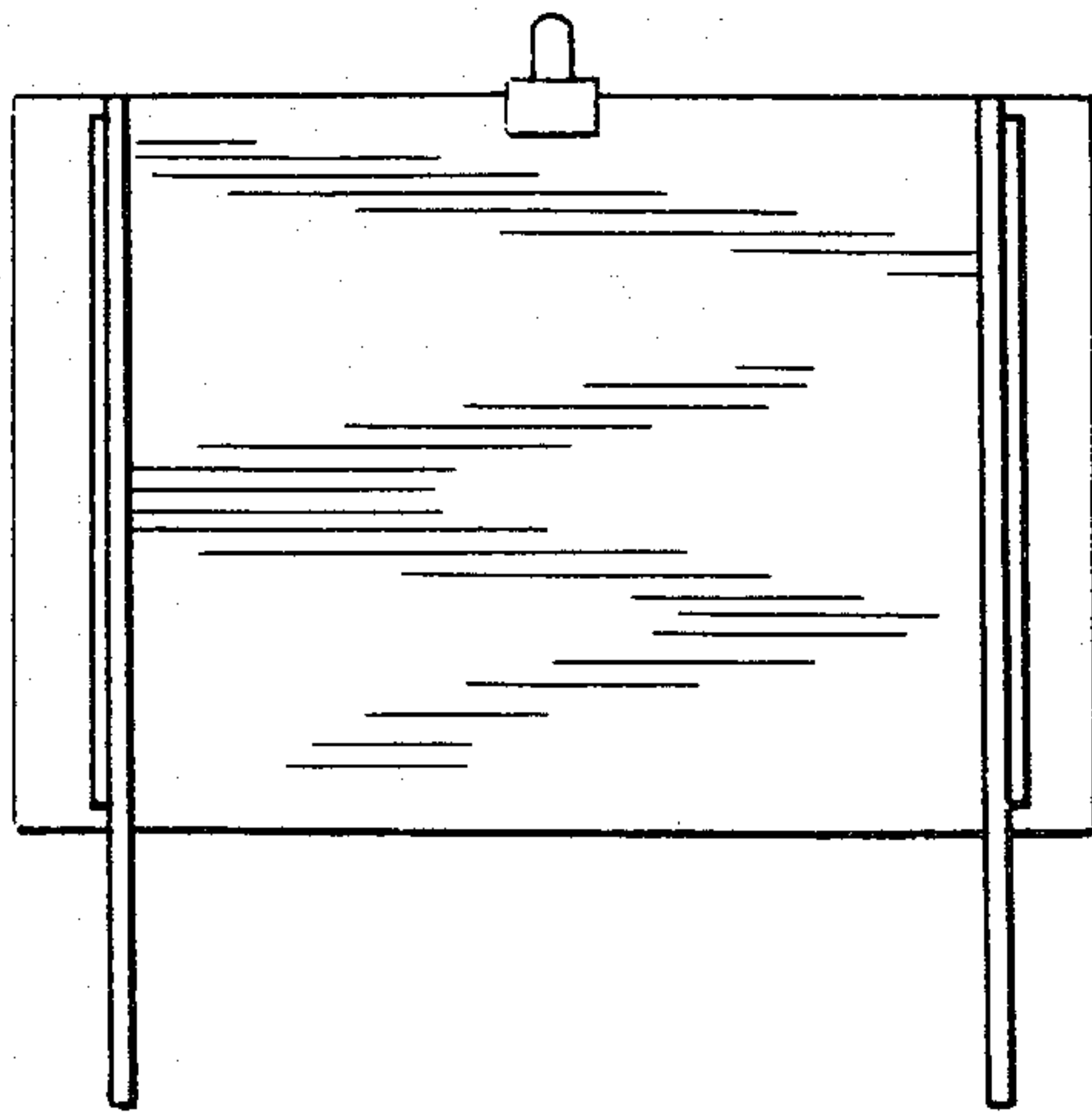
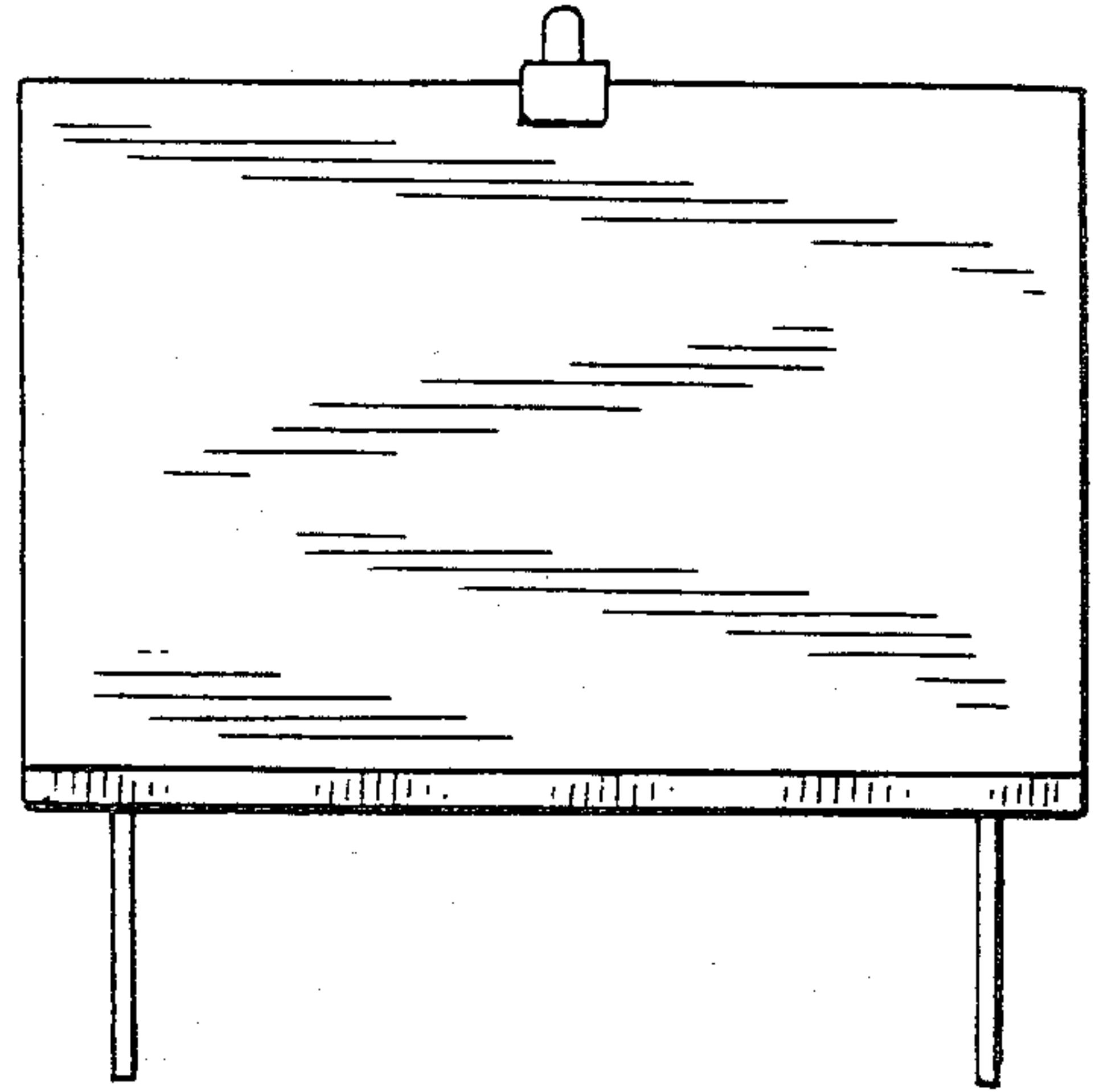

FIG. 5

FIG. 3

FIG. 6

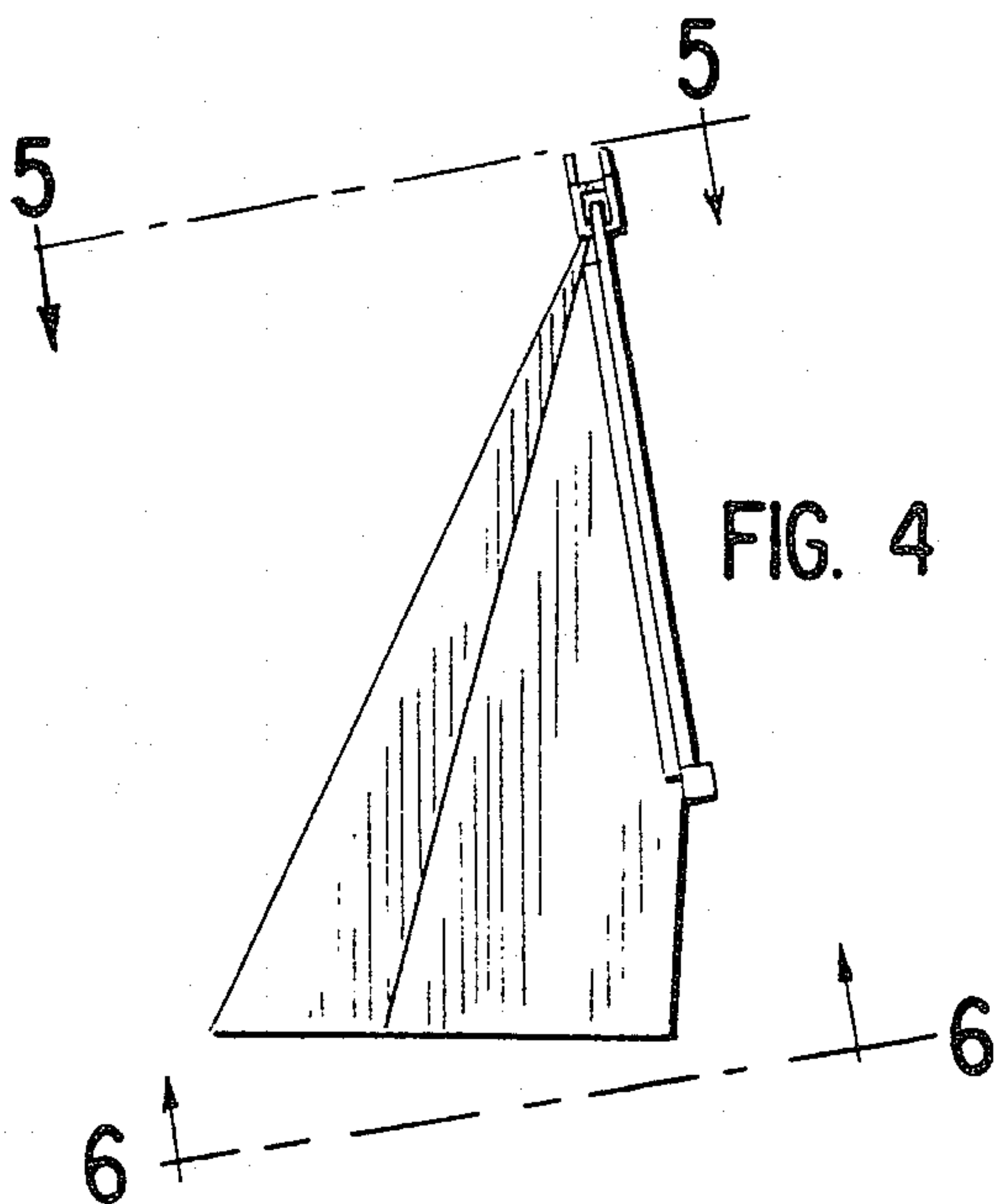
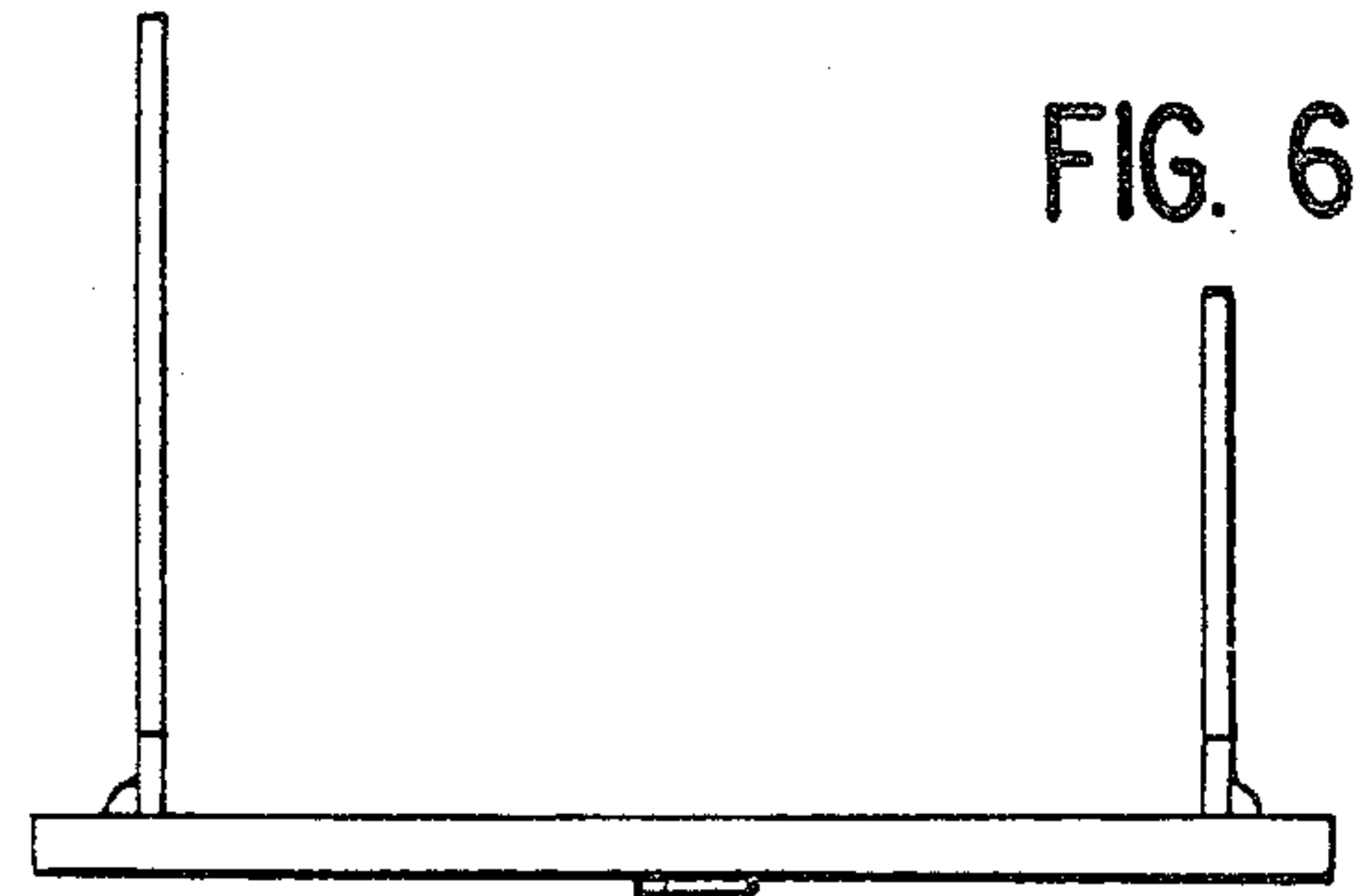

FIG. 4

FIG. 7

