

[54] COMBINED MAILBOX AND SIGNAL

[76] Inventor: Edward E. Ross, Rte. 5, Box 900, Warrensburg, Mo. 64093

[**] Term: 14 Years

[21] Appl. No.: 445,527

[22] Filed: Nov. 30, 1982

[52] U.S. Cl. D99/29

[58] Field of Search D99/28, 29, 33; 232/33, 232/34, 35; D194/168; D10/109, 113

[56] References Cited

U.S. PATENT DOCUMENTS

816,200	3/1906	Wheeler	232/34
2,480,469	8/1949	Horn	232/35
3,270,956	9/1966	Mullner	232/35
3,386,649	6/1968	Joyce	232/34
4,089,460	5/1978	Mellard	232/34
4,147,292	3/1979	Fisher	232/34 X

Primary Examiner—Bernard Ansher
Assistant Examiner—Terry Pfeffer
Attorney, Agent, or Firm—Kokjer, Kircher, Bradley, Wharton, Bowman & Johnson

[57] CLAIM

The ornamental design for a combined mailbox and signal, as shown and described.

DESCRIPTION

FIG. 1 is a top, front, left side perspective view of a combined mailbox and signal showing my new design; FIG. 2 is a front elevation thereof; FIG. 3 is a left side elevation thereof; FIG. 4 is a rear elevation thereof; FIG. 5 is a top plan view thereof; FIG. 6 is a right side elevation thereof; and FIG. 7 is a perspective view thereof with the signal shown in a released position. The undisclosed bottom portion is plane and unornamented.

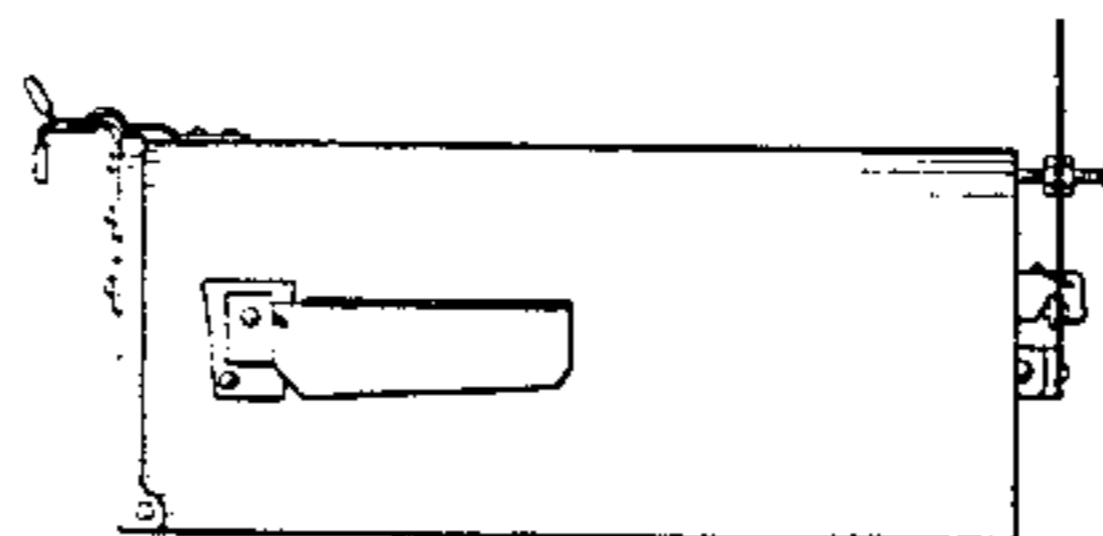
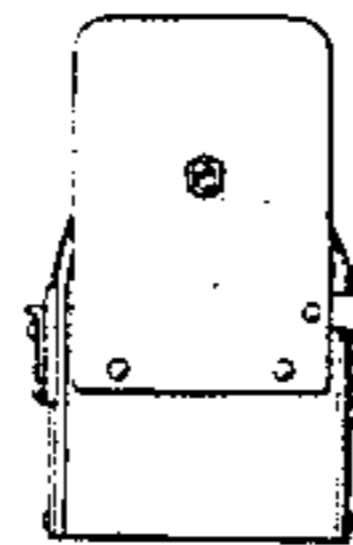
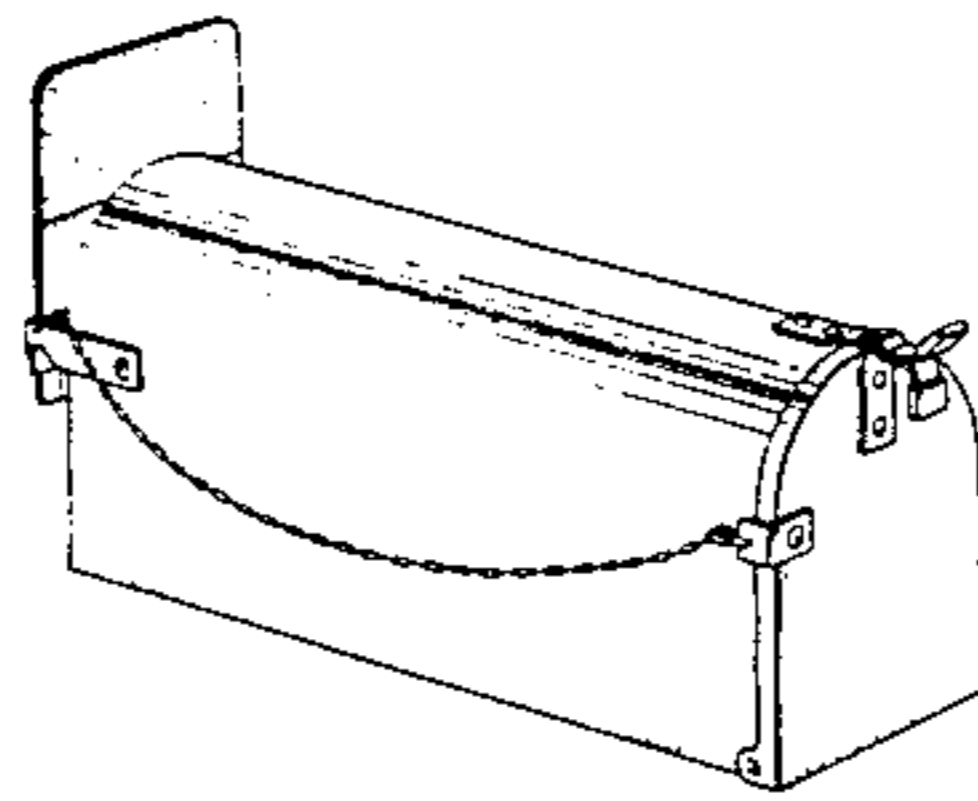

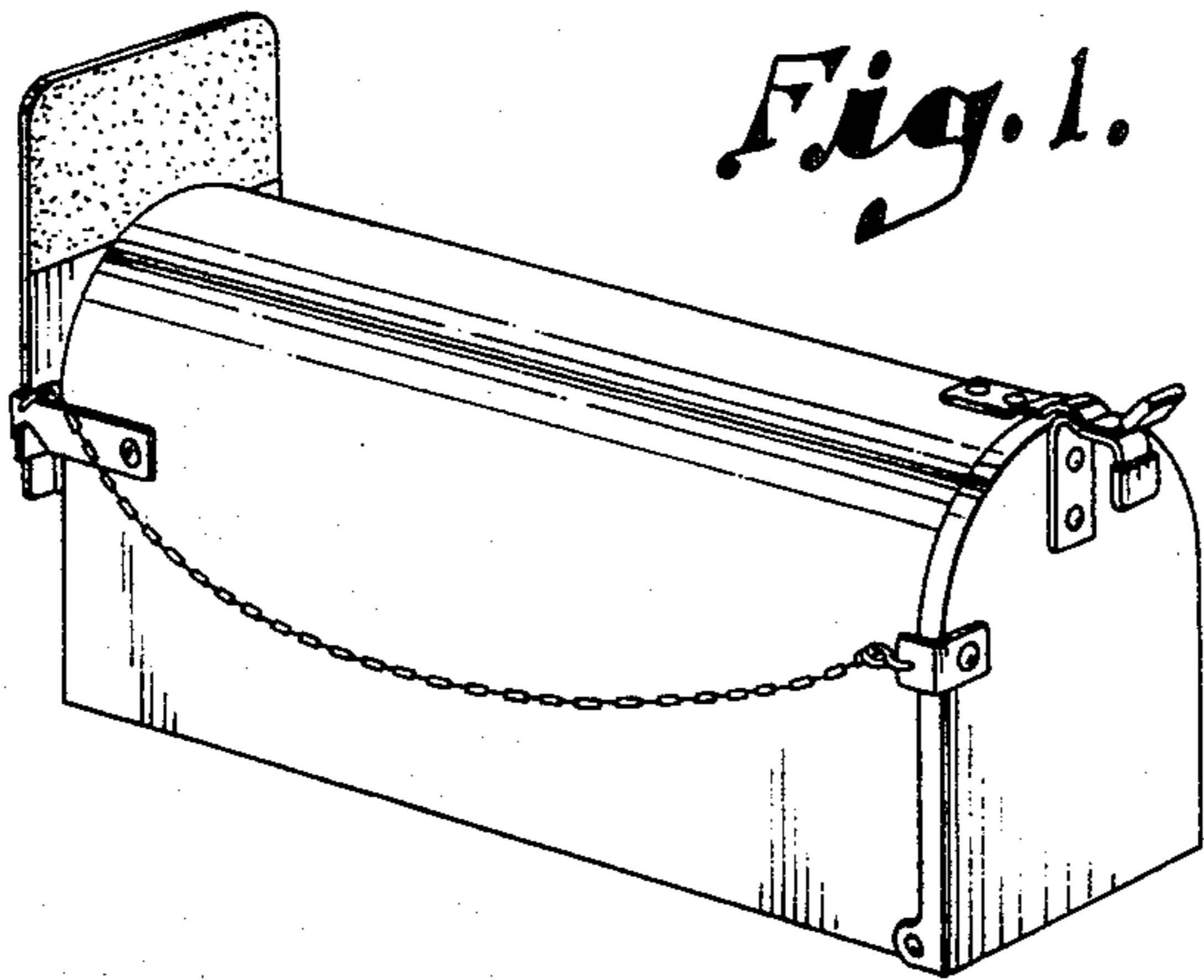

Fig. 2.

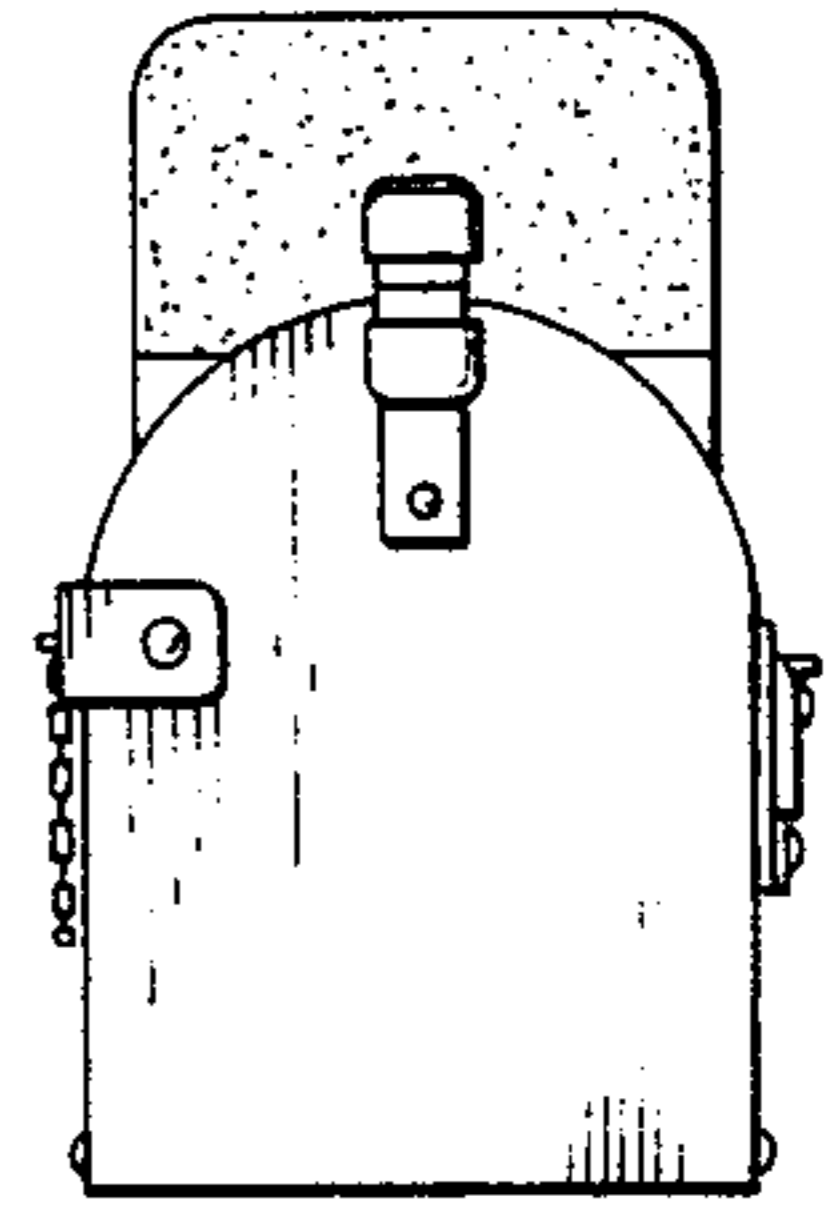

Fig. 3.

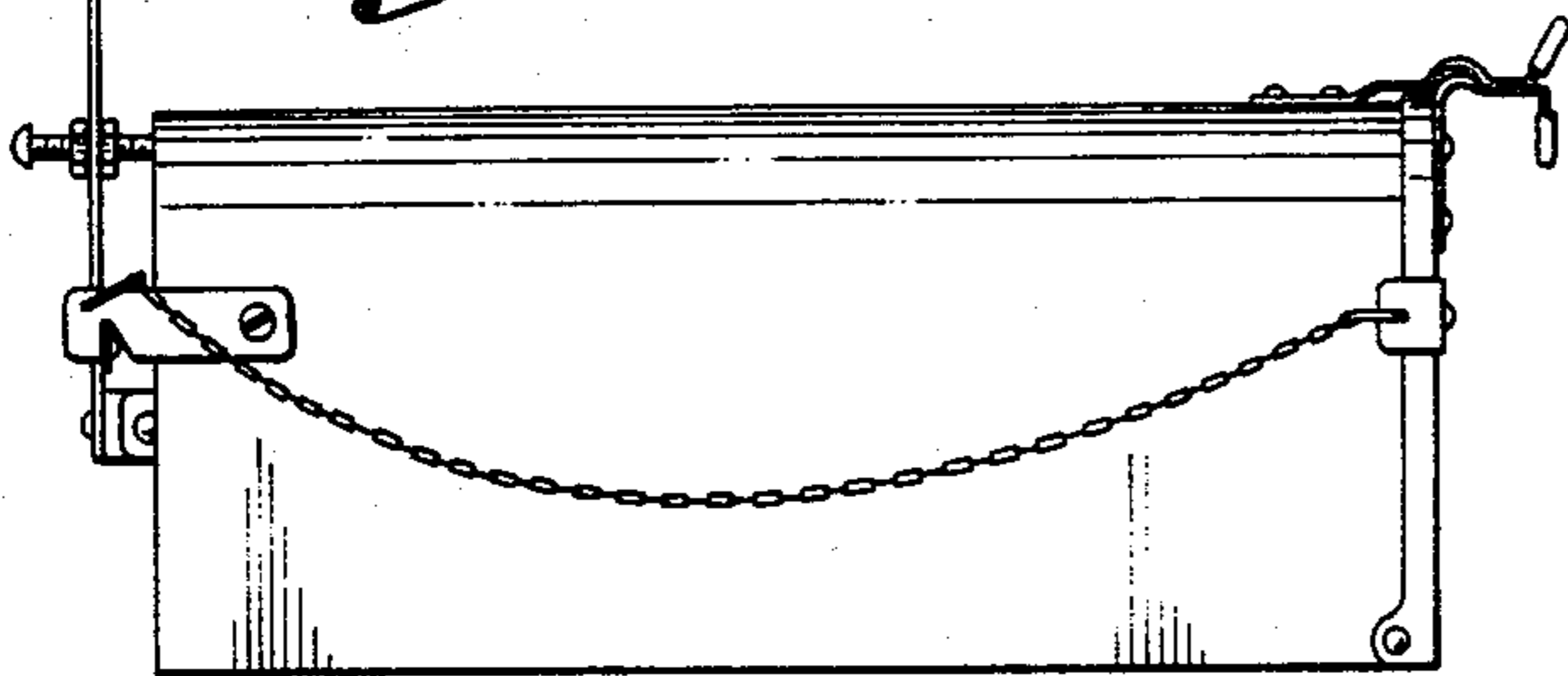

Fig. 4.

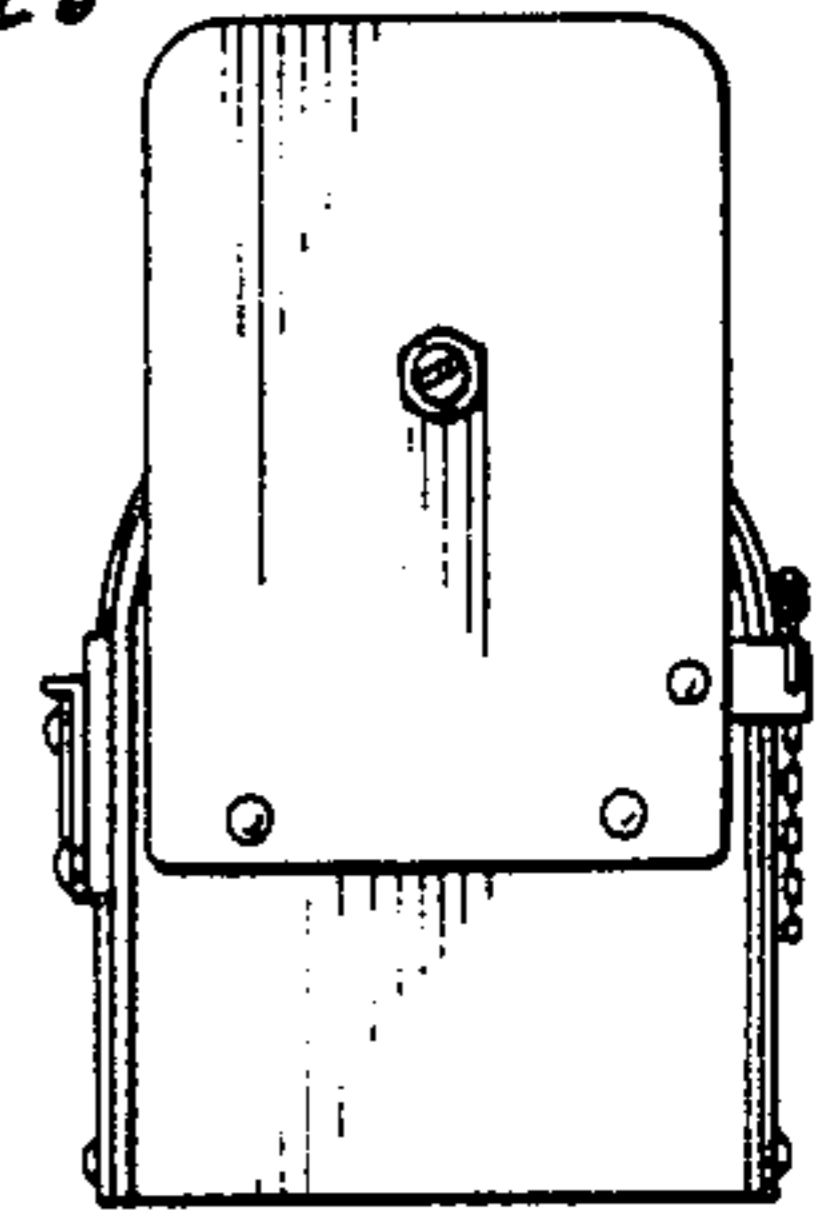

Fig. 5.

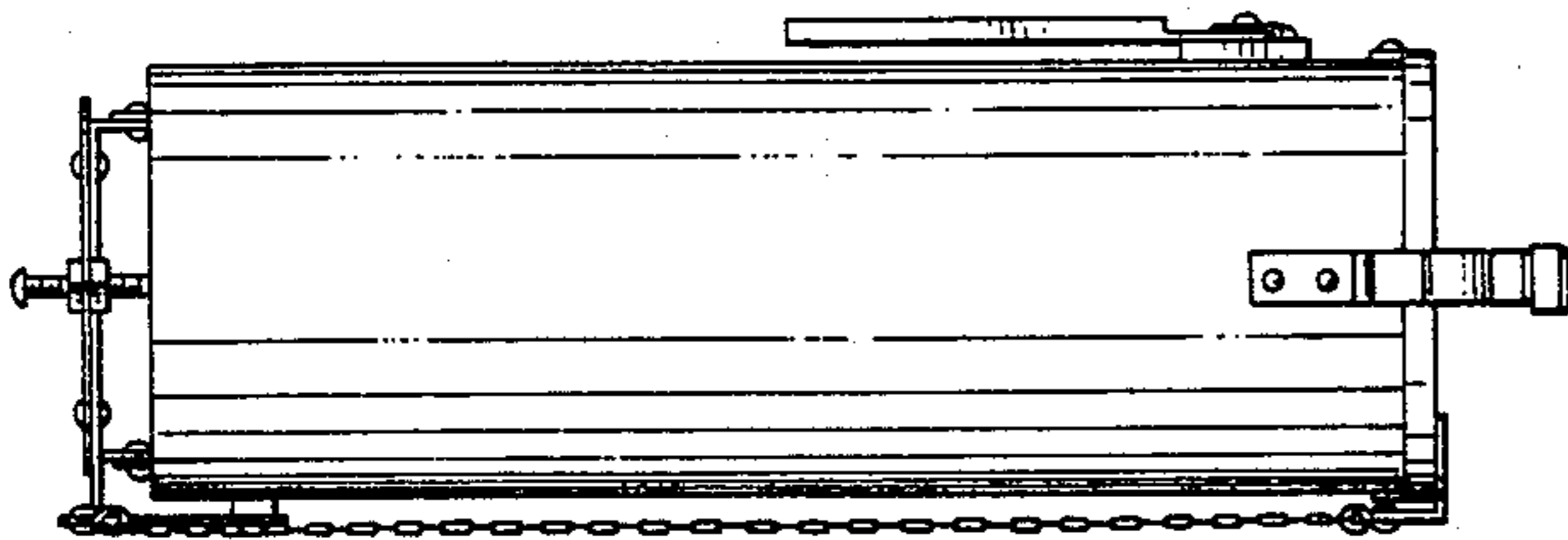

Fig. 6.

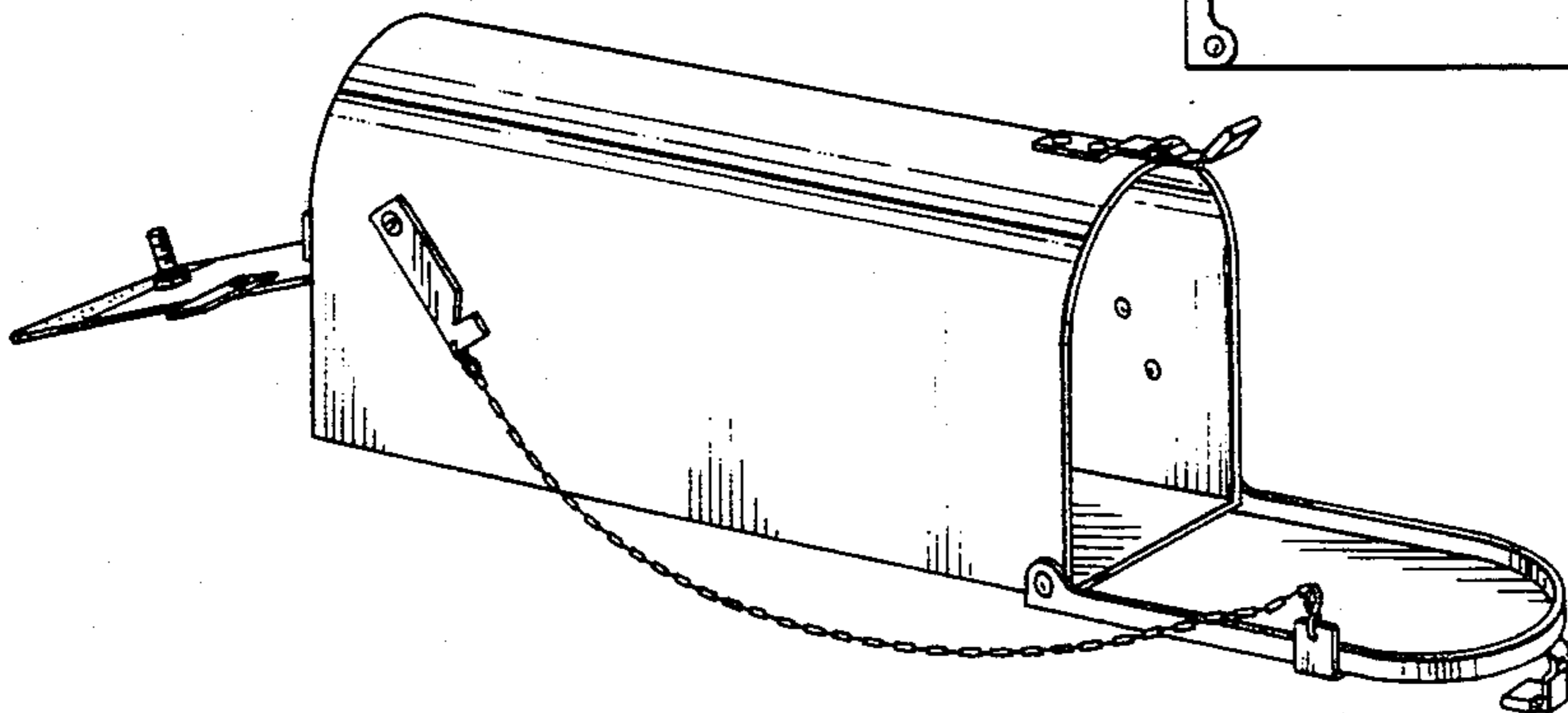
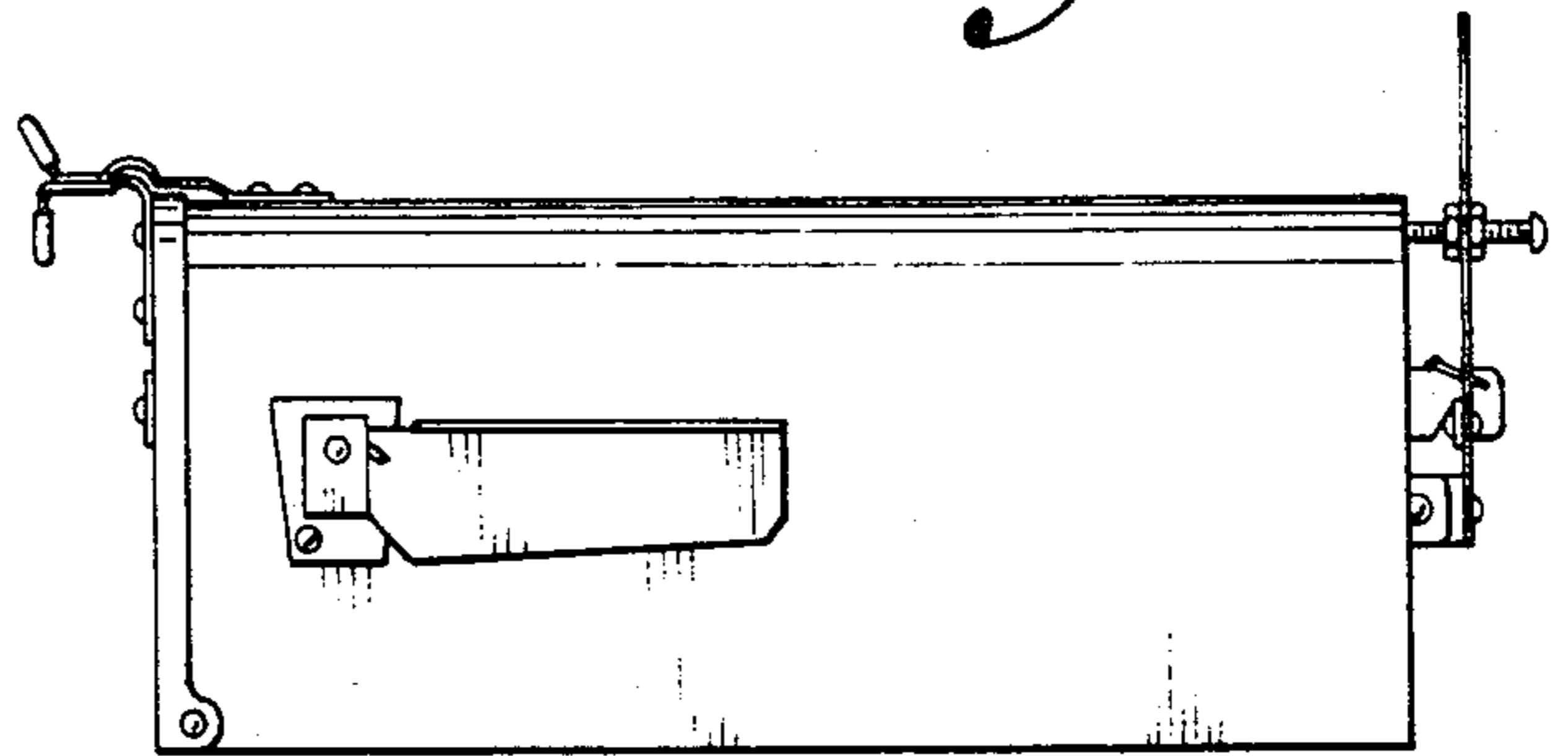

Fig. 7.