

[54] **CUTTING TOOL HOLDER**

[76] Inventor: **Joseph A. Shampang**, 676 New Britain Ave., Rocky Hill, Conn. 06067

[**] Term: **14 Years**

[21] Appl. No.: **562,826**

[22] Filed: **Dec. 19, 1983**

[52] U.S. Cl. **D8/98; D8/99**

[58] Field of Search **D8/98, 99, 100; D7/138, D7/142; 30/164.9, 164.95; 407/81, 82, 83, 84, 90**

[56] **References Cited**

U.S. PATENT DOCUMENTS

751,054	2/1904	Carr	407/83
966,755	8/1910	Kuhn	407/81
1,245,959	11/1917	O'Gara	407/81 X
2,170,590	8/1939	Hiscock	407/84 X

2,516,595	7/1950	Seafeld	407/83
4,220,428	9/1980	Suzuki	407/82 X

Primary Examiner—Susan J. Lucas
Assistant Examiner—Clare E. Heflin
Attorney, Agent, or Firm—McCormick, Paulding & Huber

[57] **CLAIM**

The ornamental design for a cutting tool holder, as shown and described.

DESCRIPTION

FIG. 1 is a front, top and left side perspective view of a cutting tool showing my new design.
FIG. 2 is a top plan view thereof.
FIG. 3 is a front elevational view thereof.
FIG. 4 is a bottom plan view thereof.
FIG. 5 is a rear elevational view thereof.
FIG. 6 is a left-hand end view thereof.
FIG. 7 is a right-hand end view thereof.

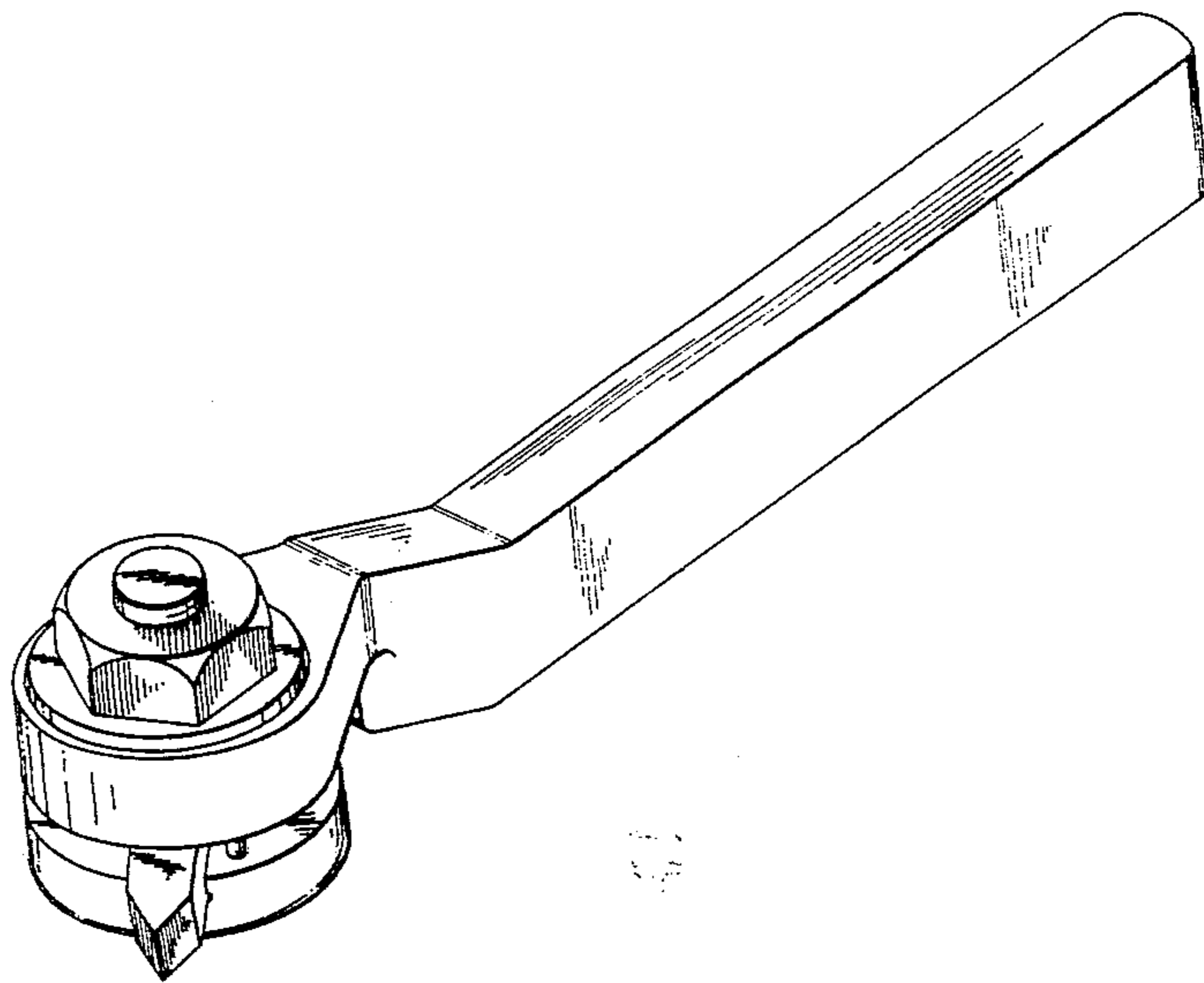

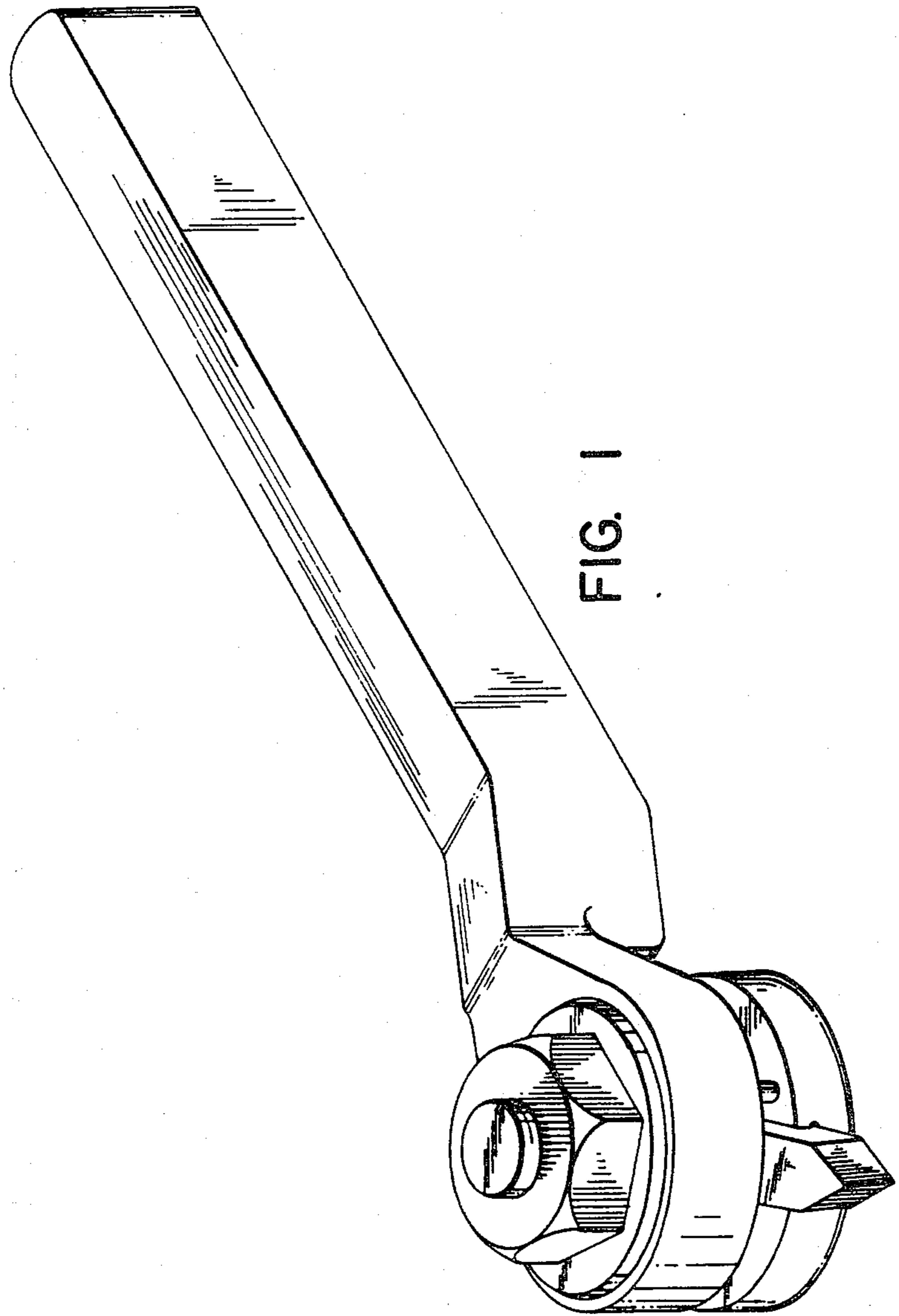

FIG. 1

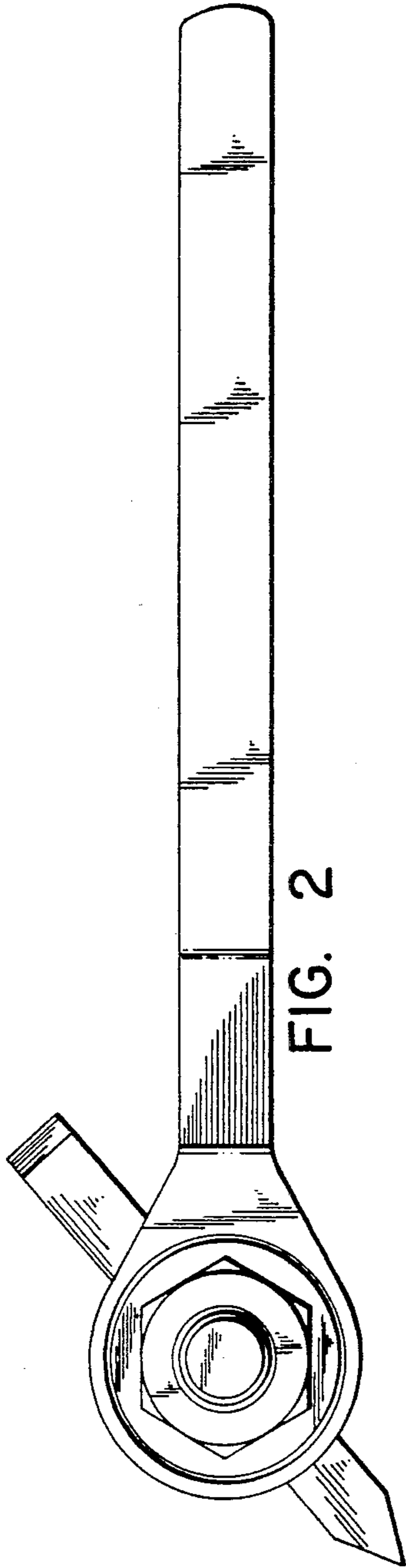

FIG. 2

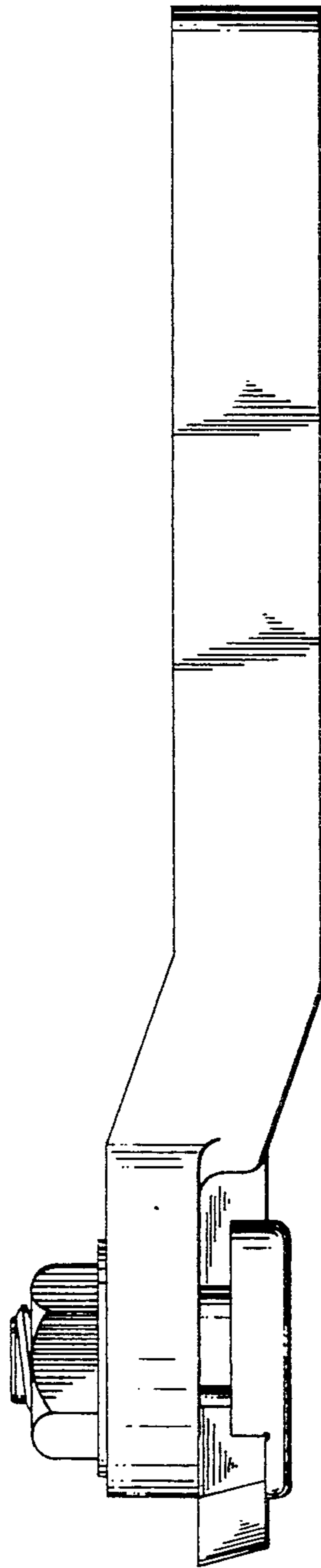

FIG. 3

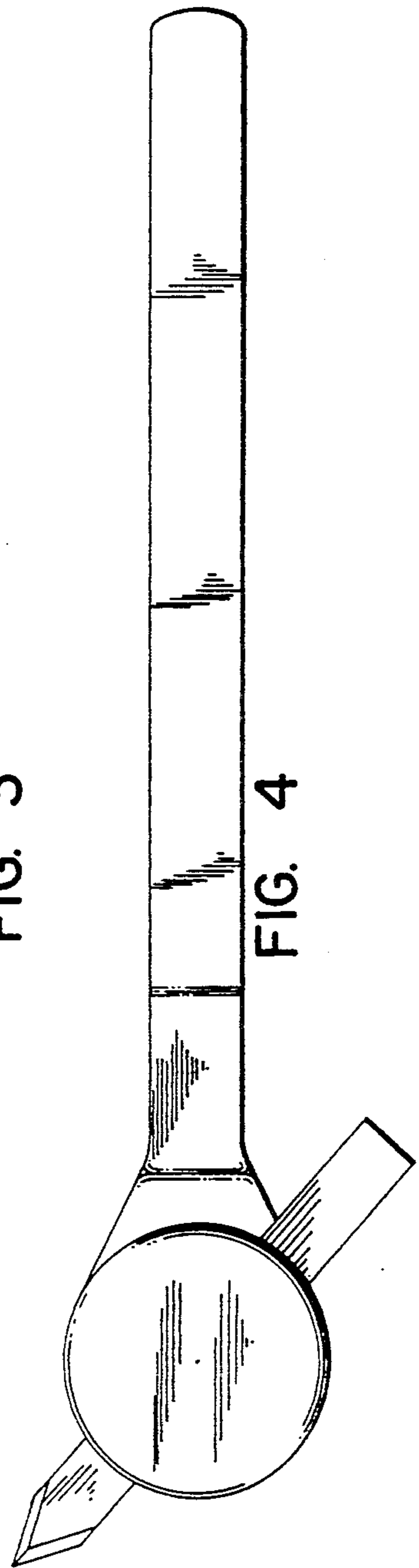

FIG. 4

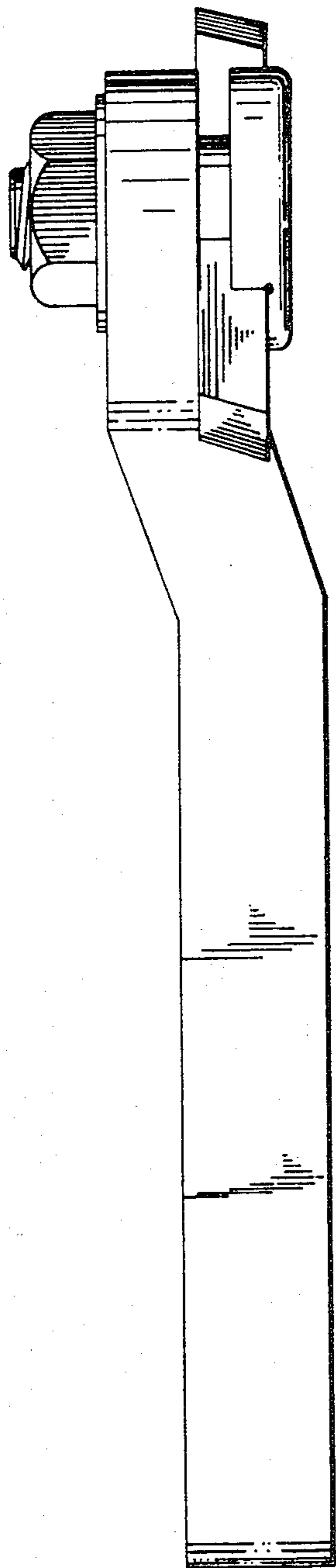

FIG. 5

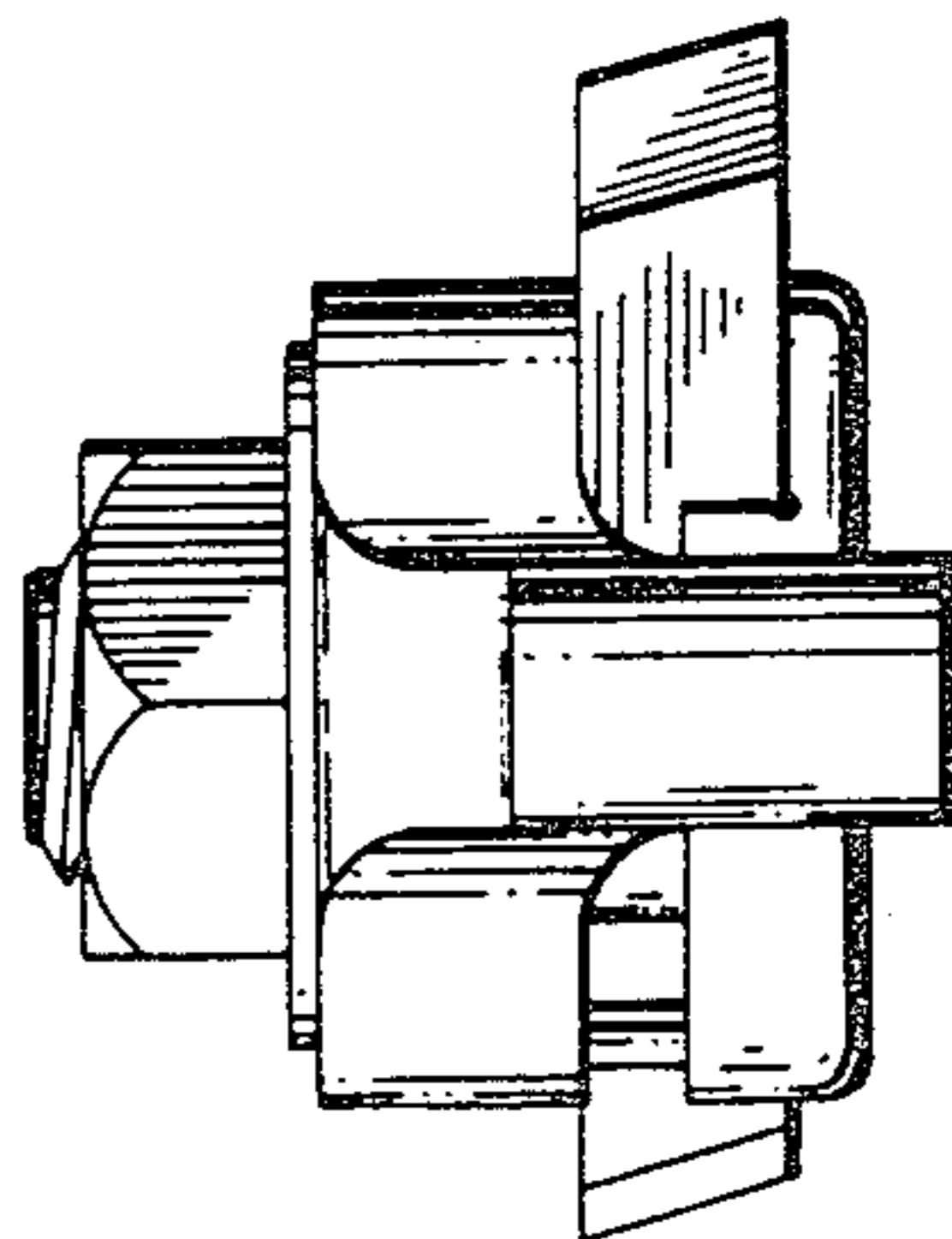

FIG. 7

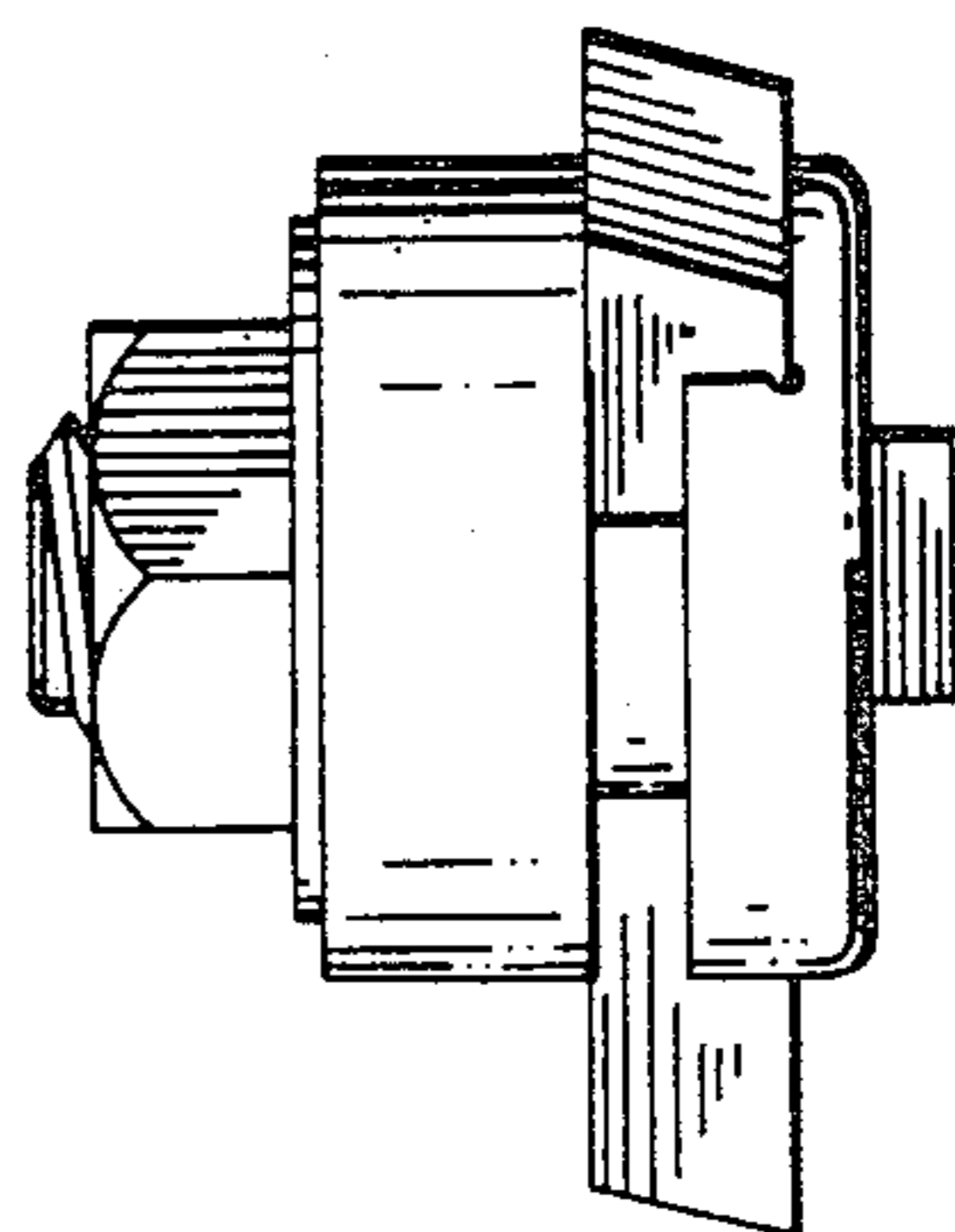

FIG. 6