

[54] INFLATABLE DOME HAT

[75] Inventor: Timothy J. Saari, Rosemount, Minn.

[73] Assignee: Jack Carmichael Advertising, Inc., Minneapolis, Minn.

[\*\*] Term: 14 Years

[21] Appl. No.: 446,641

[22] Filed: Dec. 3, 1982

[52] U.S. Cl. .... D2/244

[58] Field of Search ..... D2/230, 239, 244, 250, D2/256, 253, 231; 2/171, 198, 171.3, DIG. 6, 10, 11, 197; 272/8 R, 8 N

[56] References Cited

U.S. PATENT DOCUMENTS

D. 177,484	4/1956	Schaghman et al. ....	D2/239
D. 266,370	10/1982	Boden .....	D2/244
735,790	8/1903	Meerza .....	2/171.3
2,593,188	4/1952	Rikelman .....	2/DIG. 10
2,684,484	7/1954	Rossmann .....	2/197
3,068,865	12/1962	Laszlo .....	D2/231 X
4,324,005	4/1982	Willis .....	2/DIG. 10 X

Primary Examiner—Carmen H. Vales

Attorney, Agent, or Firm—Merchant, Gould, Smith, Edell, Welter & Schmidt

[57] CLAIM

The ornamental design for an inflatable dome hat, substantially as shown.

DESCRIPTION

FIG. 1 is a front and top right perspective view of an inflatable dome hat showing my new design, as seen when worn;

FIG. 2 is a left side elevational view thereof;

FIG. 3 is a right side elevational view thereof;

FIG. 4 is a front elevational view thereof;

FIG. 5 is a rear elevational view thereof;

FIG. 6 is a top plan view thereof;

FIG. 7 is a bottom plan view thereof;

FIG. 8 is a front and top right perspective view similar to FIG. 1 in a deflated condition;

FIG. 9 is a left side elevational view thereof;

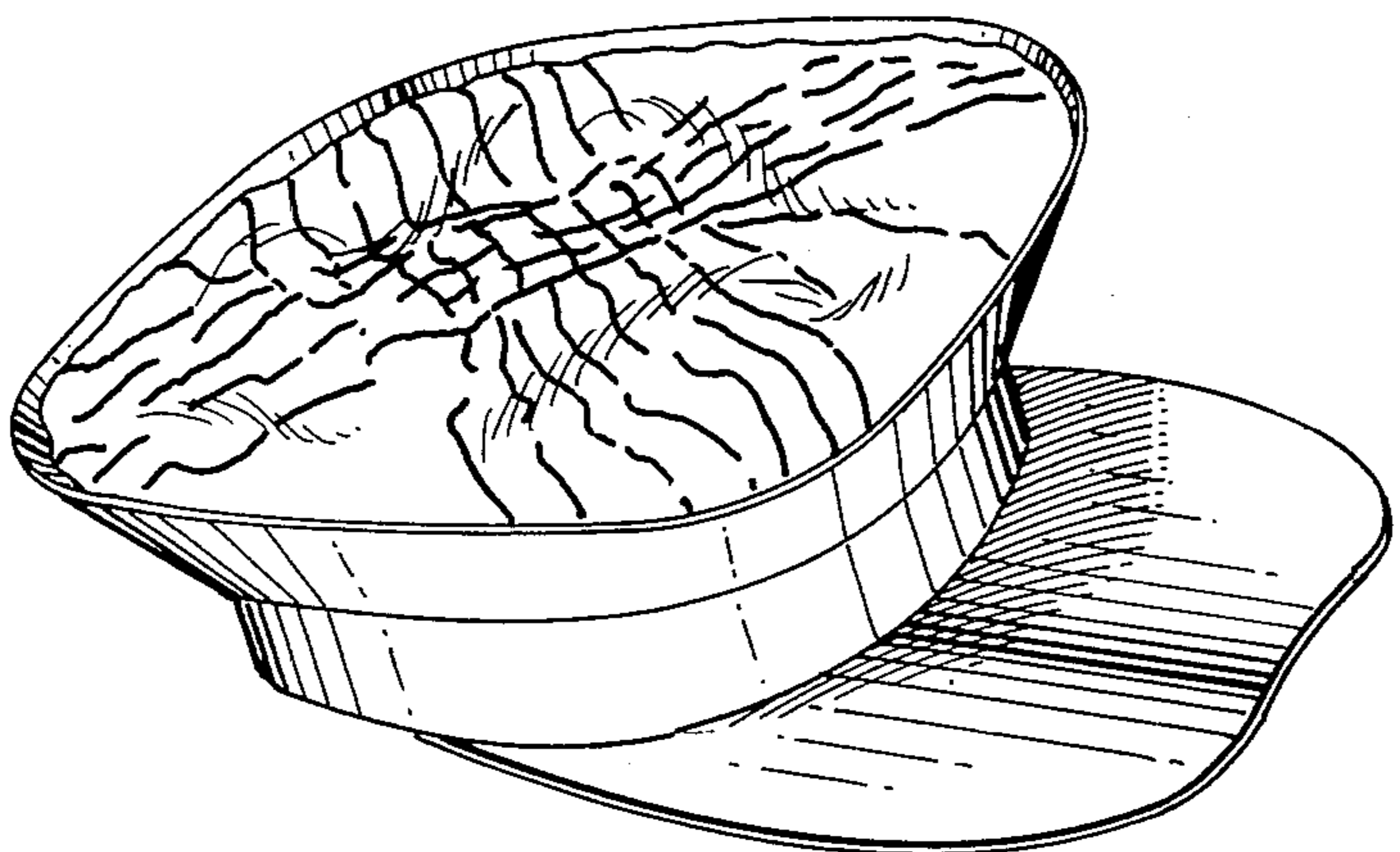
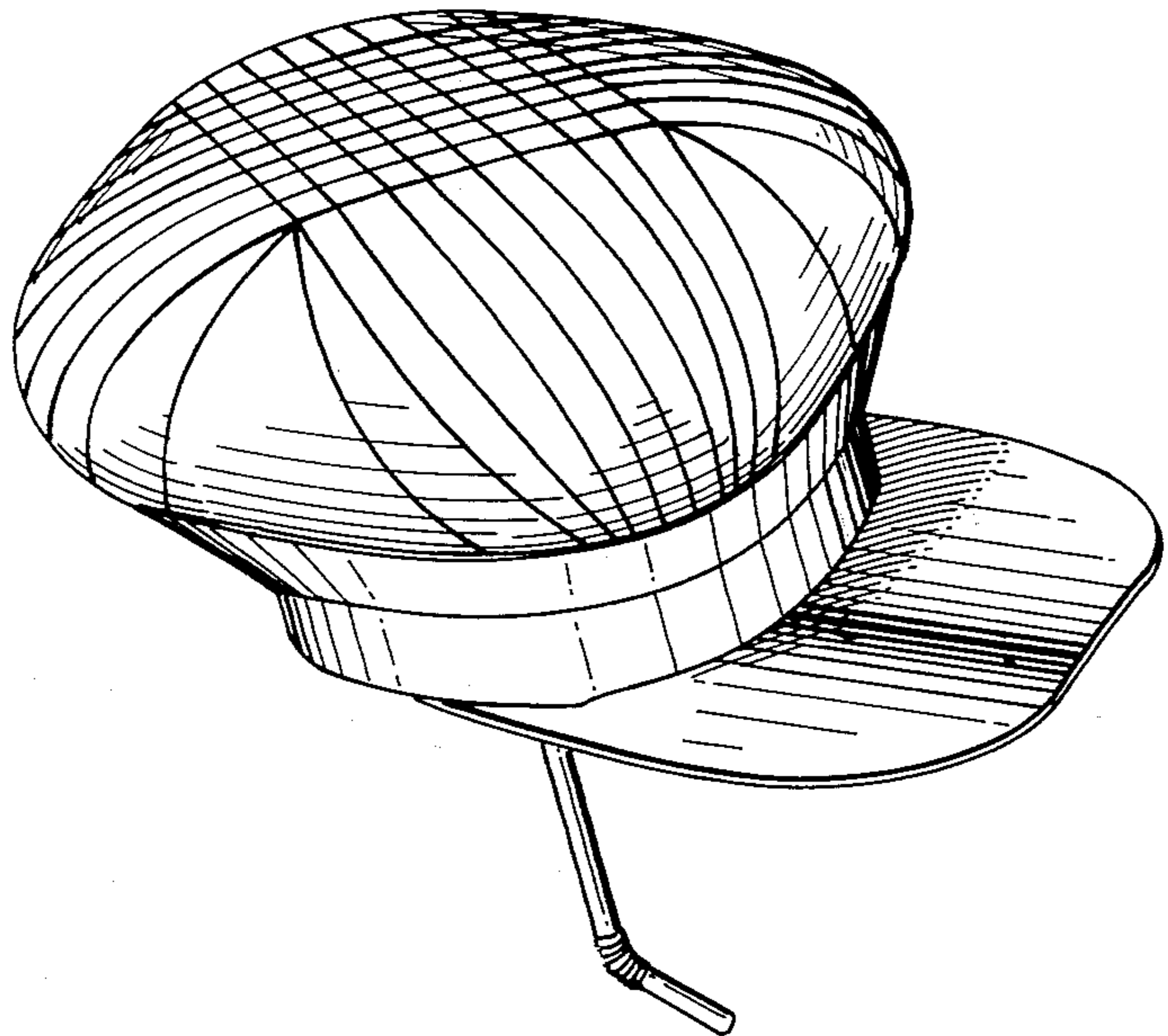
FIG. 10 is a right side elevational view thereof;

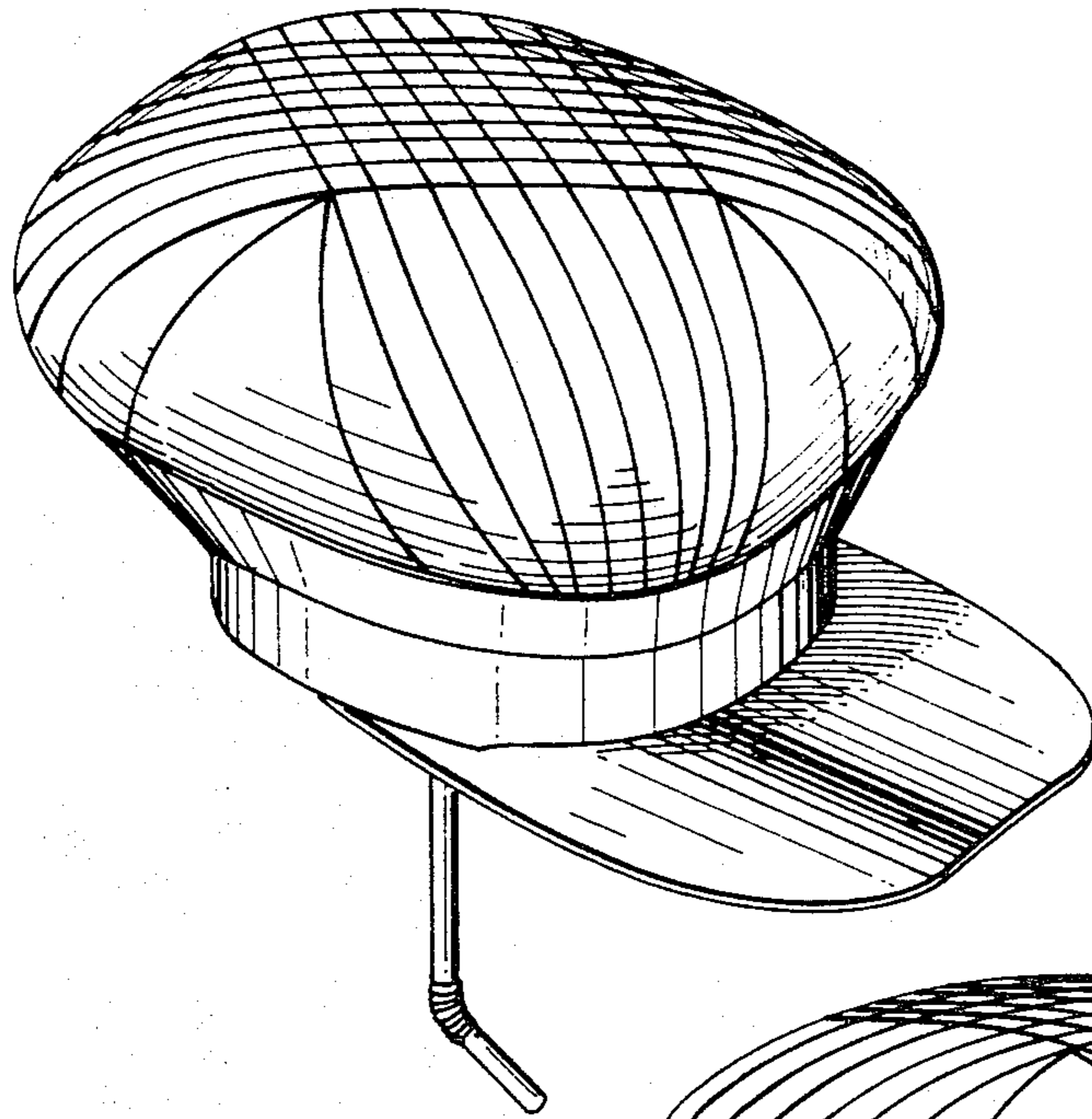
FIG. 11 is a front elevational view thereof;

FIG. 12 is a rear elevational view thereof;

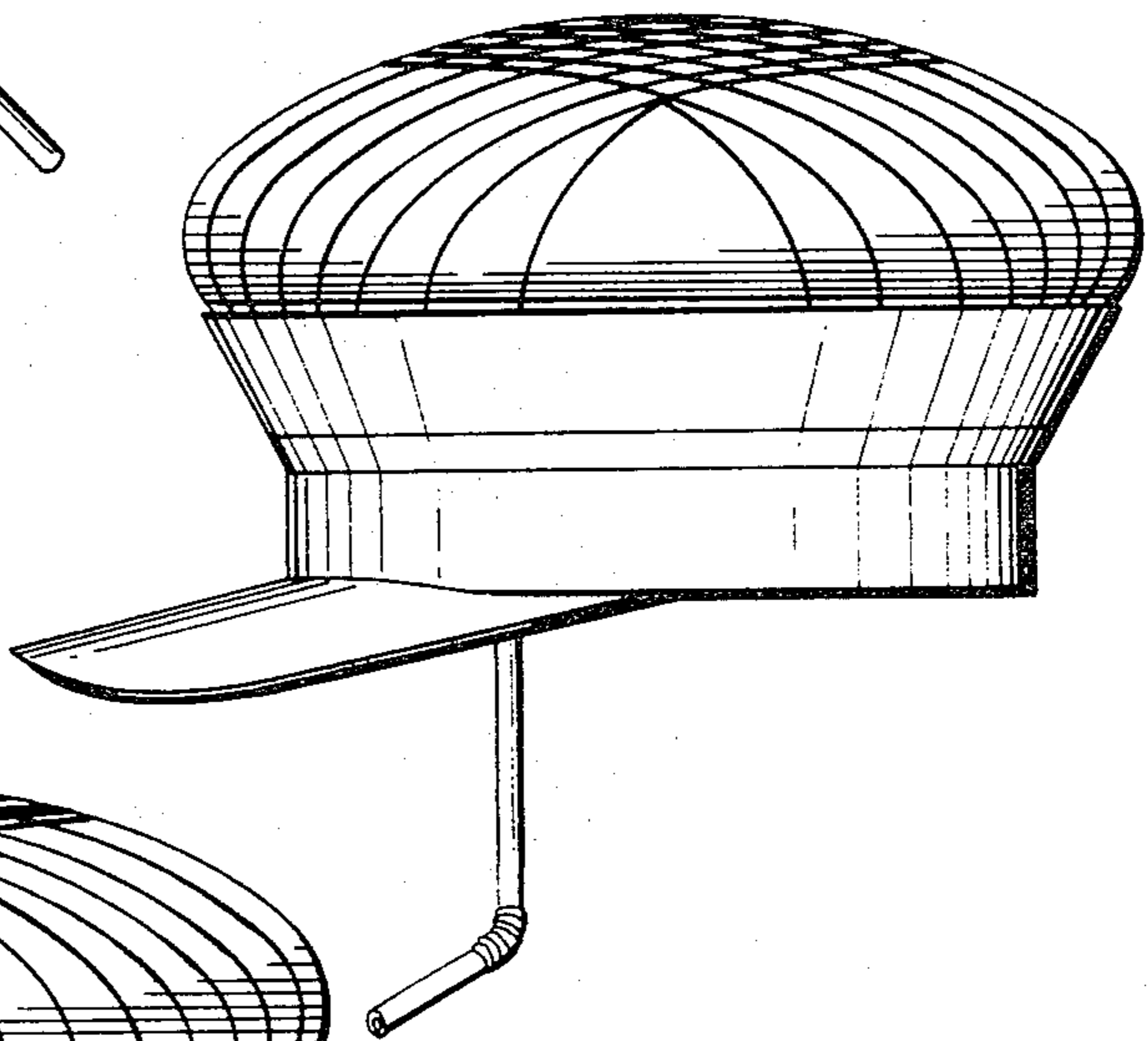
FIG. 13 is a top plan view thereof; and

FIG. 14 is a bottom plan view thereof.

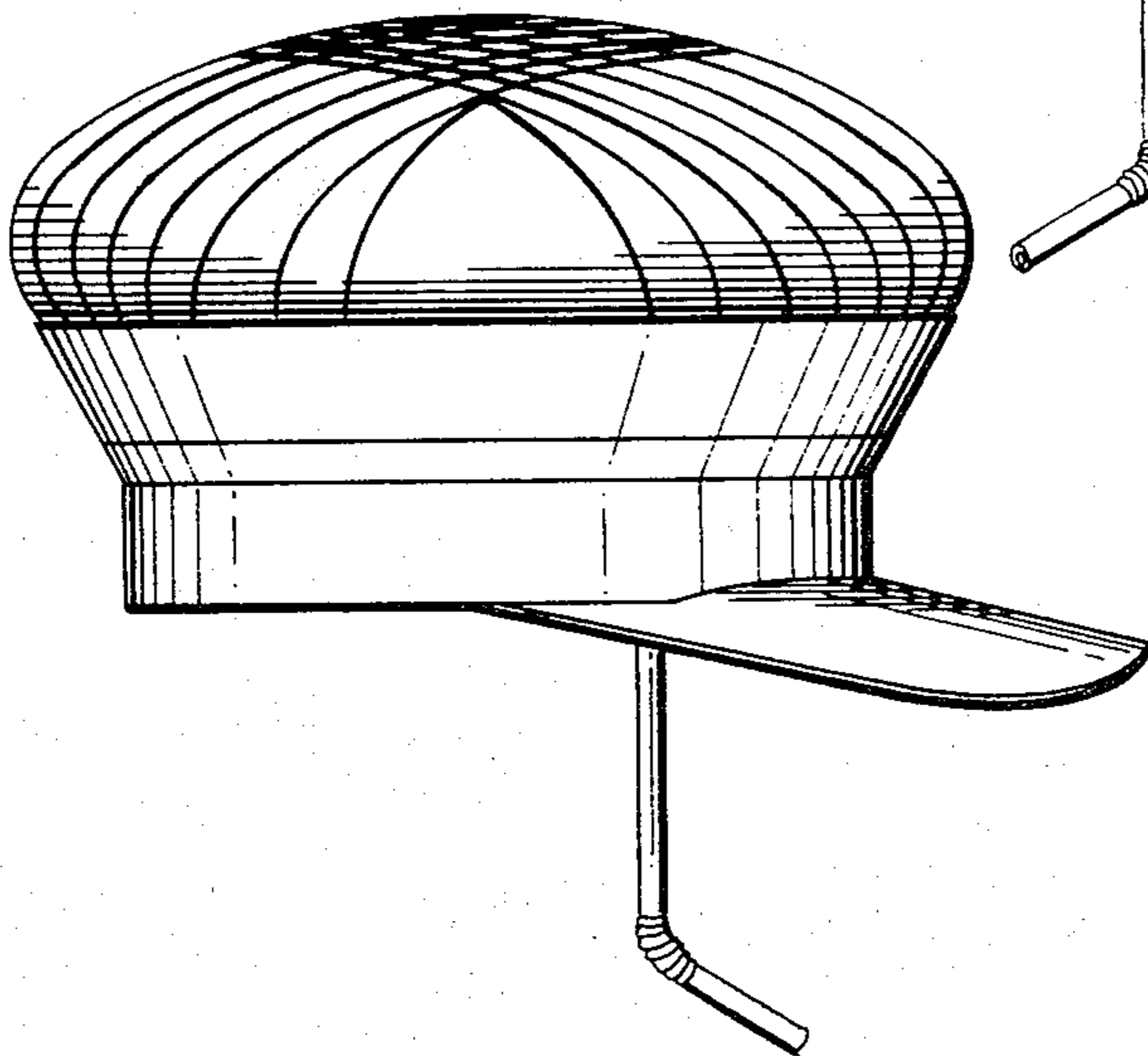




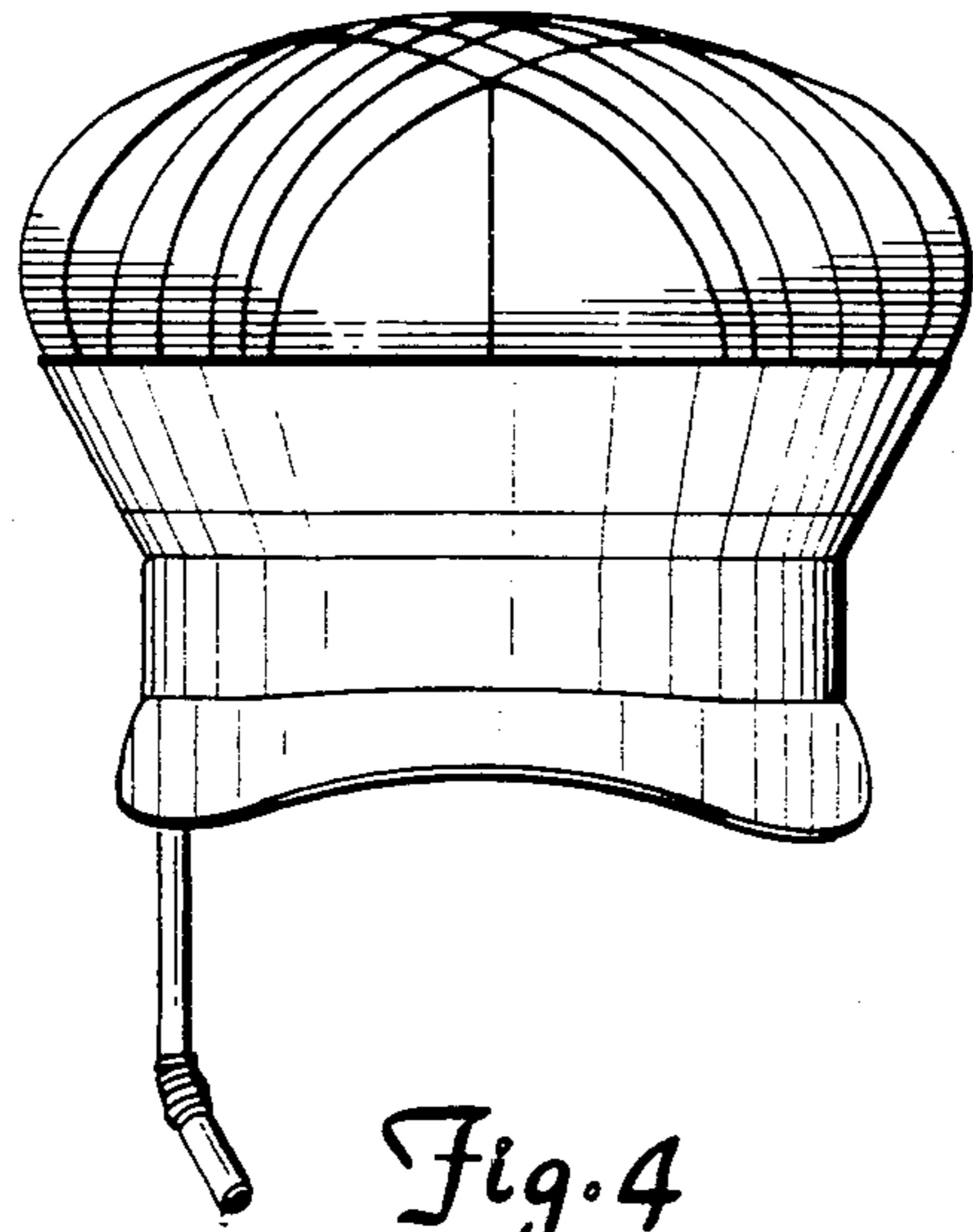
*Fig. 1*



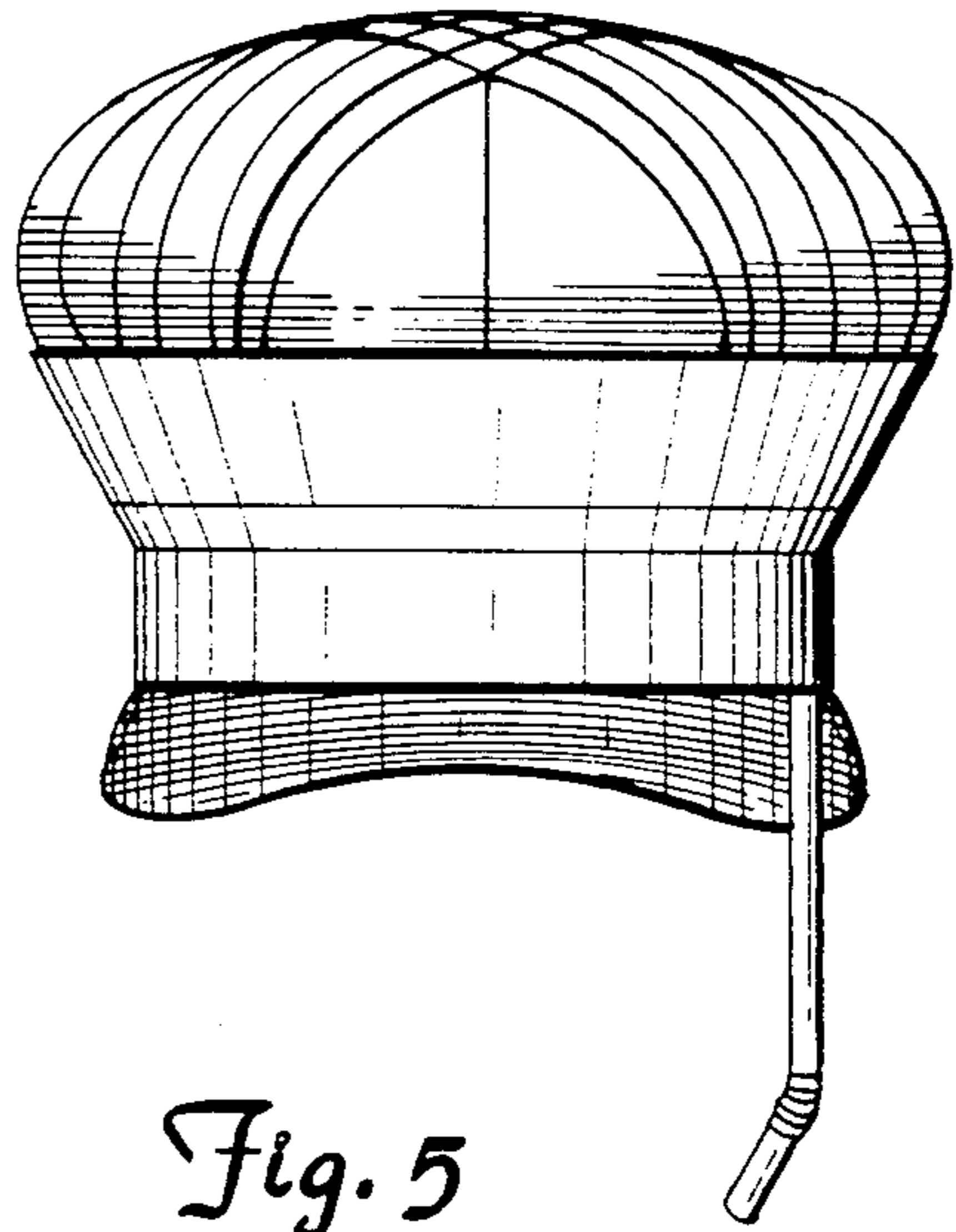
*Fig. 2*



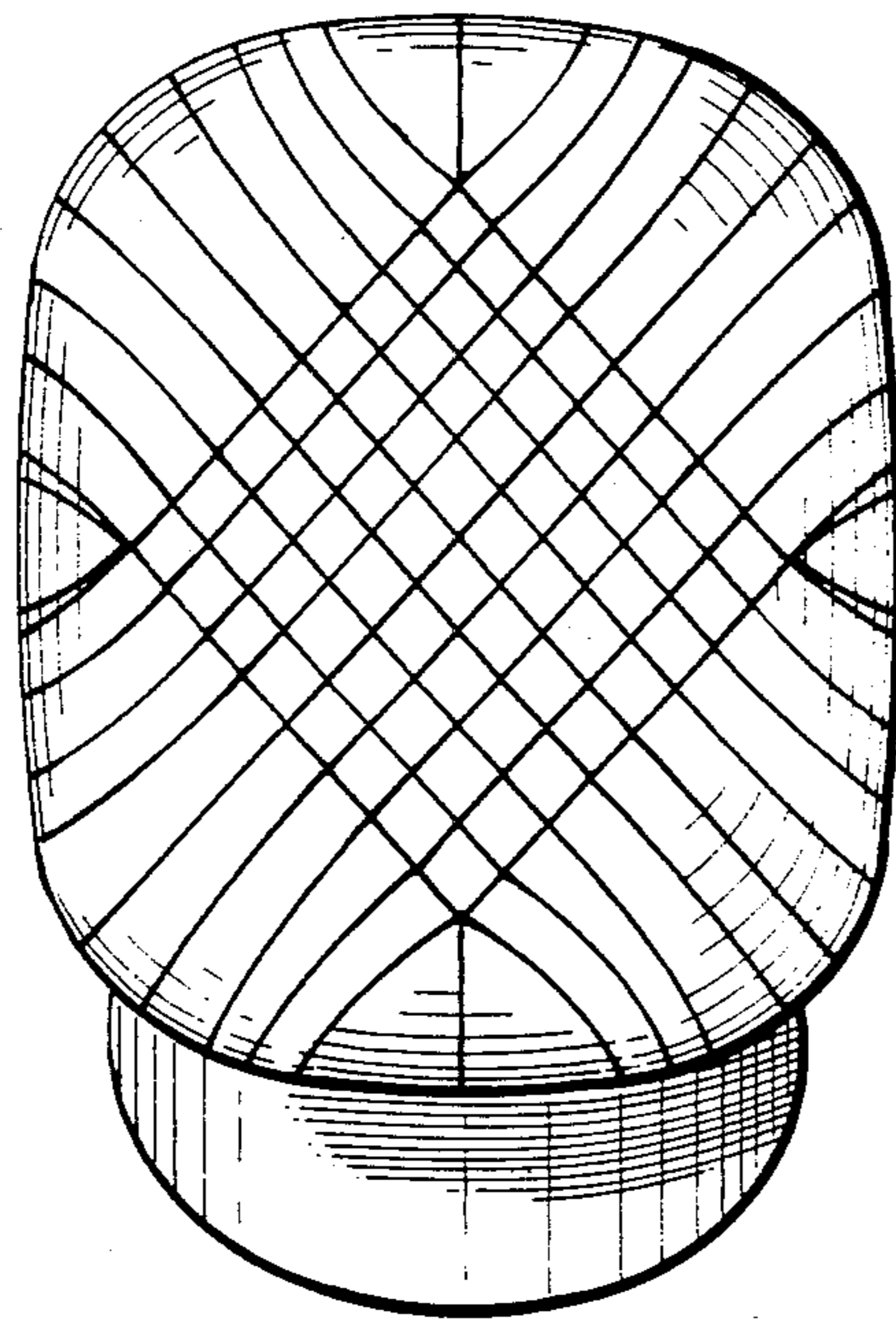
*Fig. 3*



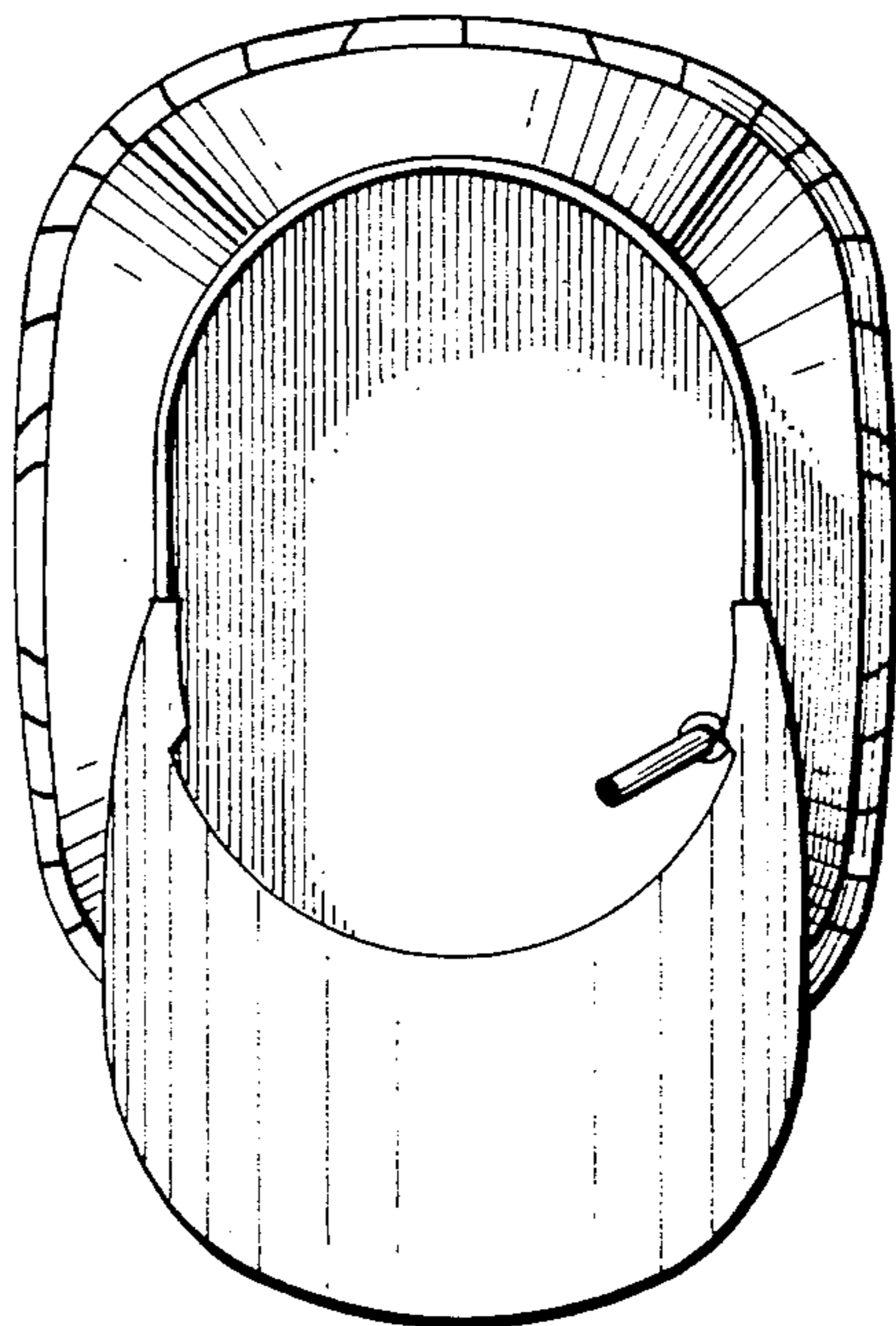
*Fig. 4*



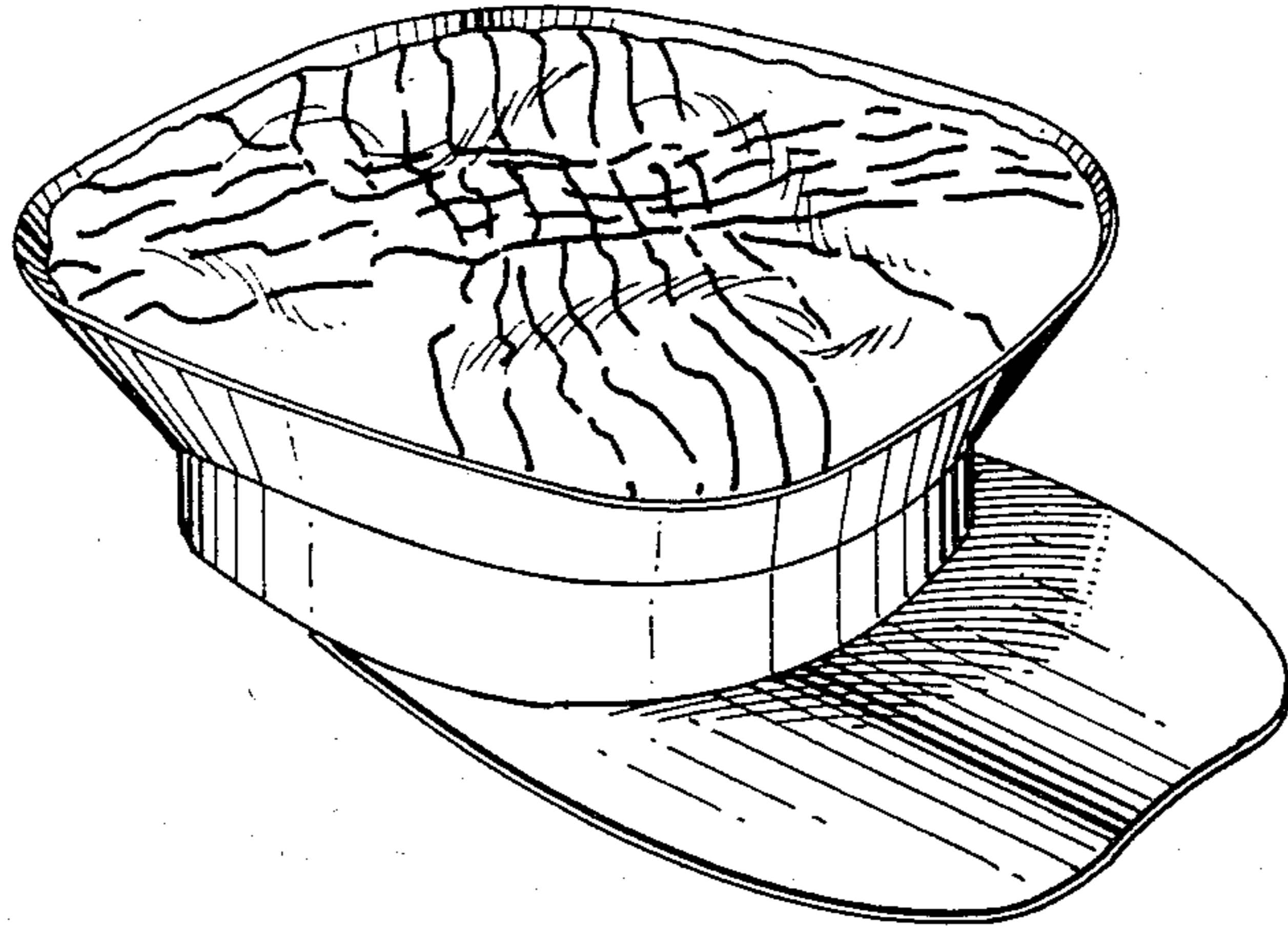
*Fig. 5*



*Fig. 6*

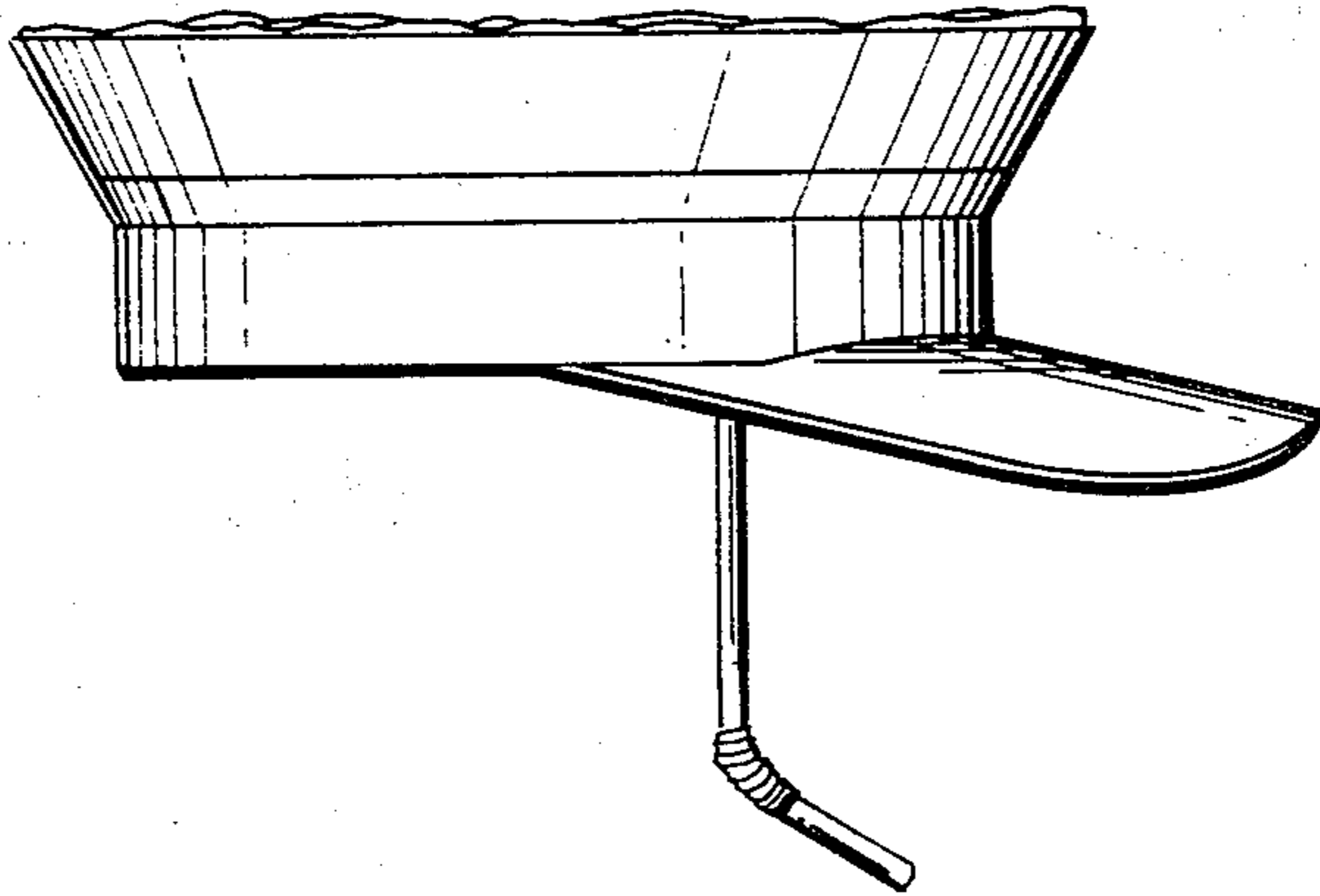
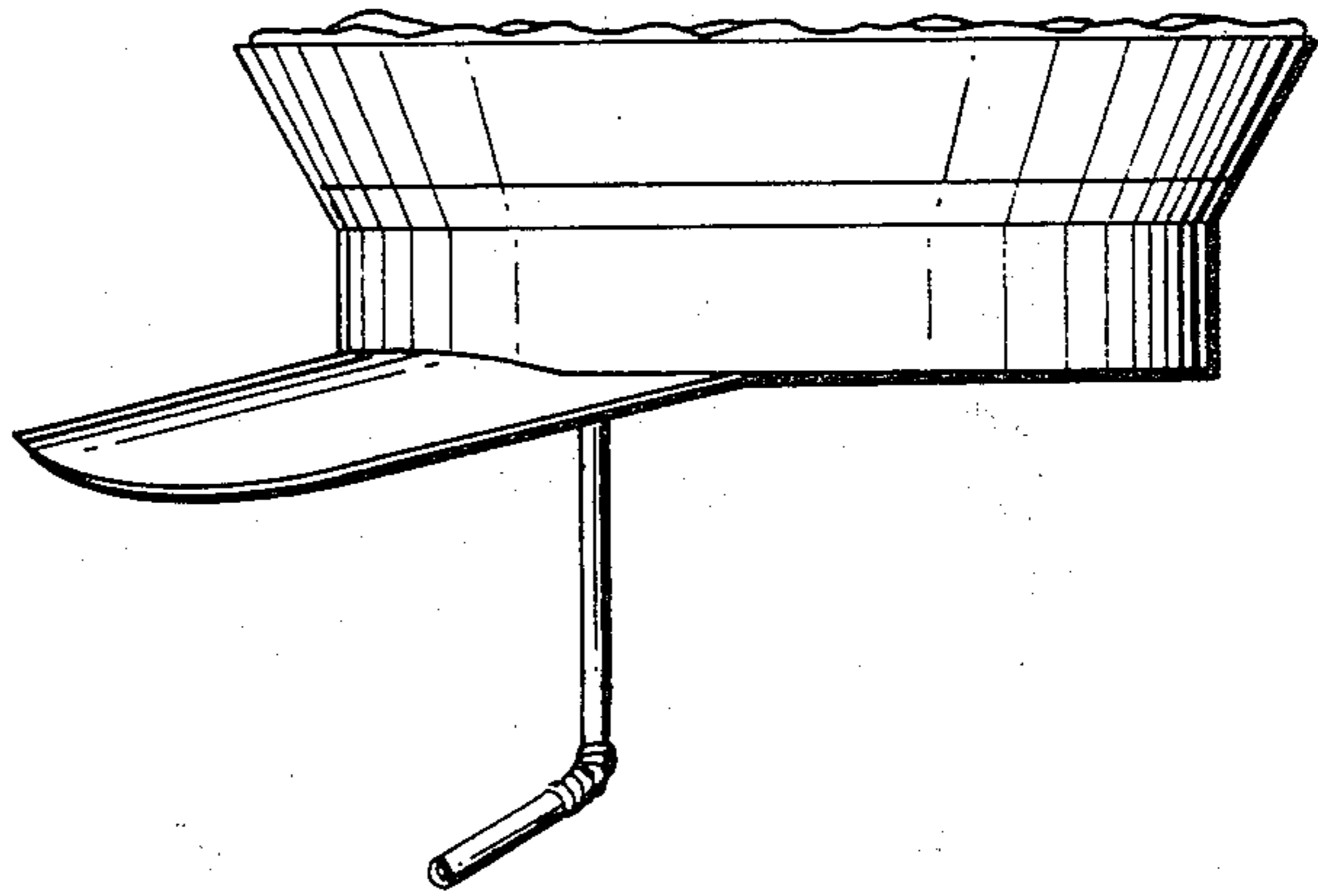


*Fig. 7*



*Fig. 8*

*Fig. 9*



*Fig. 10*

