

United States Patent [19]

Mahowald

[11] Patent Number: **Des. 278,354**

[45] Date of Patent: **** Apr. 9, 1985**

[54] **RACK FOR HANGING SOFT COVER BOOKS**

[76] Inventor: **John E. Mahowald**, 1401 Klepper Ave., Kingsburg, Calif. 93631

[**] Term: **14 Years**

[21] Appl. No.: **514,560**

[22] Filed: **Jul. 18, 1983**

[52] U.S. Cl. **D19/91**

[58] Field of Search D6/185, 184, 142, 99, D6/100; D19/90, 91, 65, 75; 248/175, 441.0, 153, 340; 211/42, 181; 281/15 A; 312/184, 233; 383/9

[56] **References Cited**

U.S. PATENT DOCUMENTS

- D. 170,098 7/1953 Swanson D6/184
- D. 212,291 9/1968 Hamilton D6/85
- D. 246,593 12/1977 Paquette D19/91

- D. 253,775 12/1979 Lar Rieu D19/91
- 4,175,602 11/1979 Cavalaris 383/9

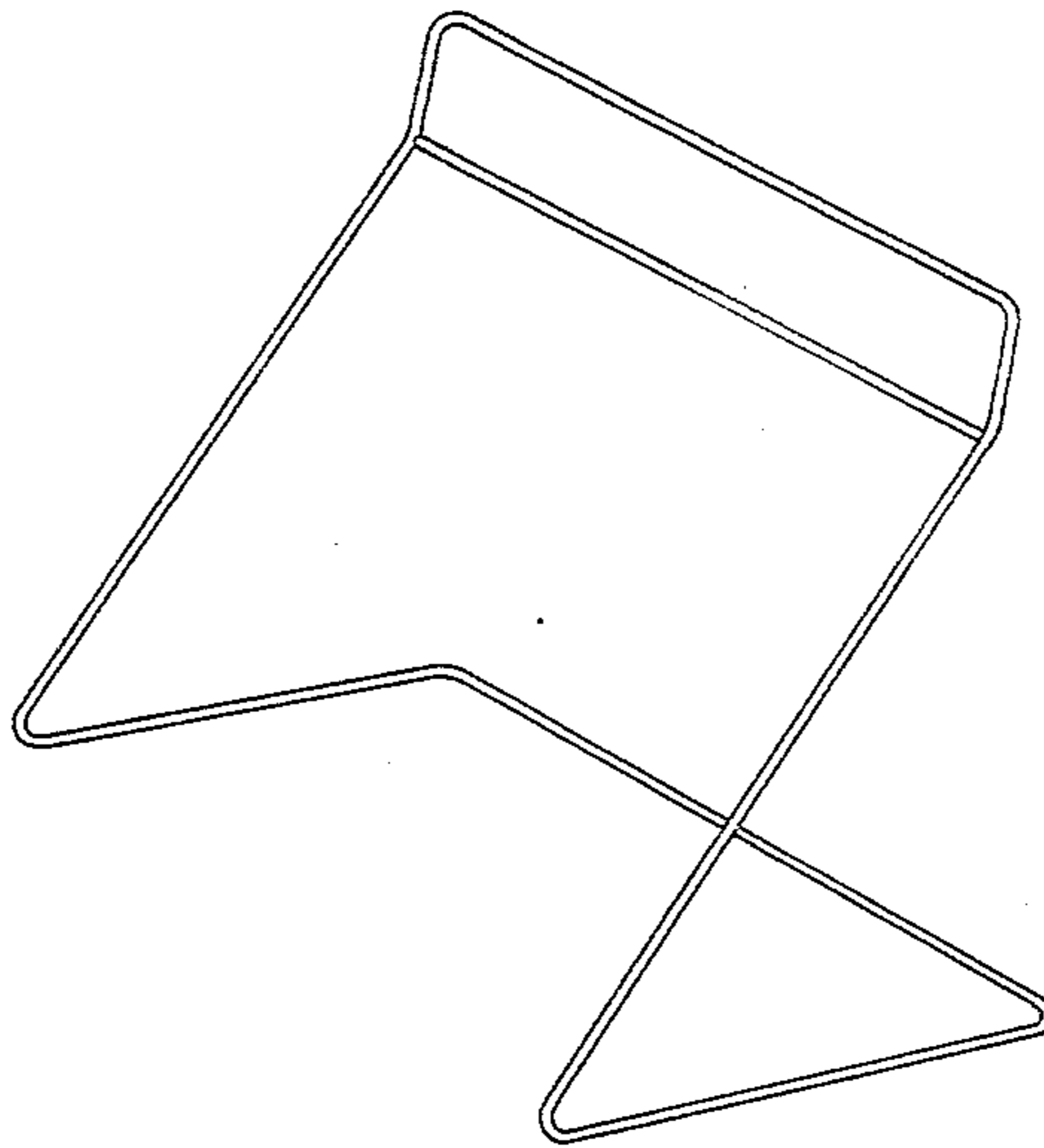
Primary Examiner—George P. Word
Attorney, Agent, or Firm—Manfred M. Warren; Robert B. Chickering; Glen R. Grunewald

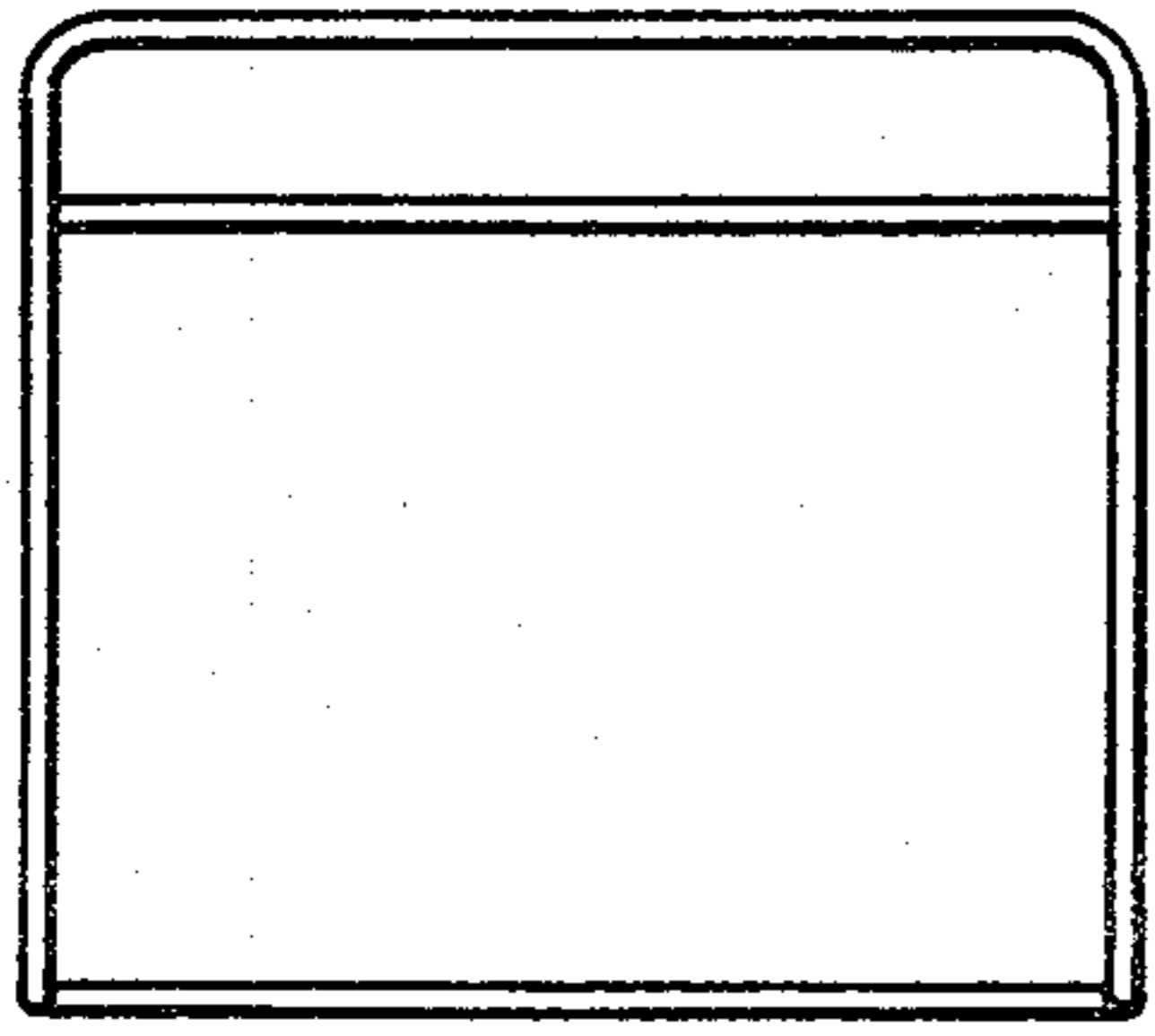
[57] **CLAIM**

The ornamental design for a rack for hanging soft cover books, as shown and described.

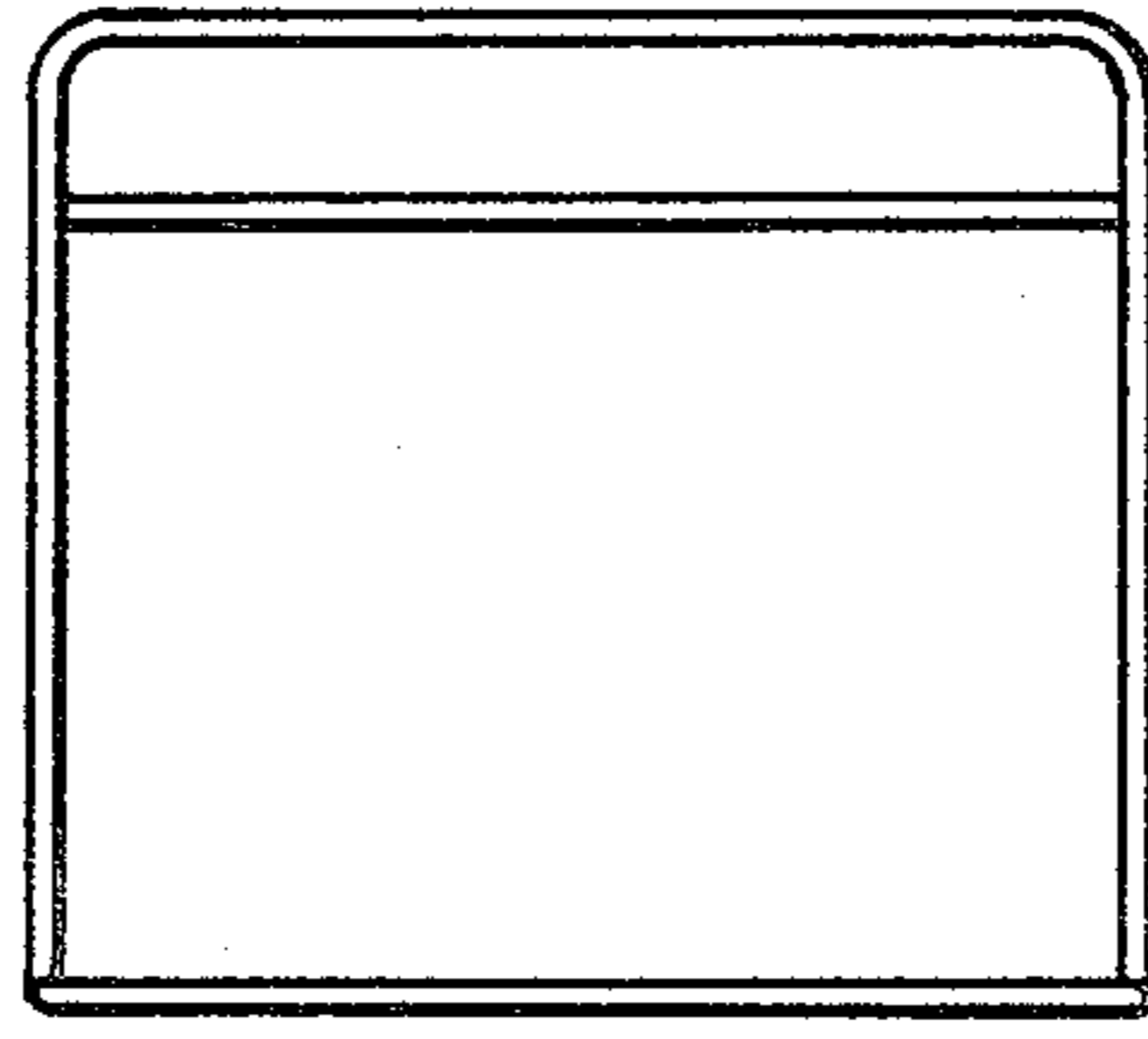
DESCRIPTION

FIG. 1 is a front elevational of a rack for hanging soft cover books showing my new design; FIG. 2 is a rear elevational thereof; FIG. 3 is a right side elevational thereof; FIG. 4 is a left side elevational thereof; FIG. 5 is a top plan view thereof; FIG. 6 is a bottom plan view thereof; and FIG. 7 is a perspective view thereof having a larger scale than FIGS. 1-6 inclusive.

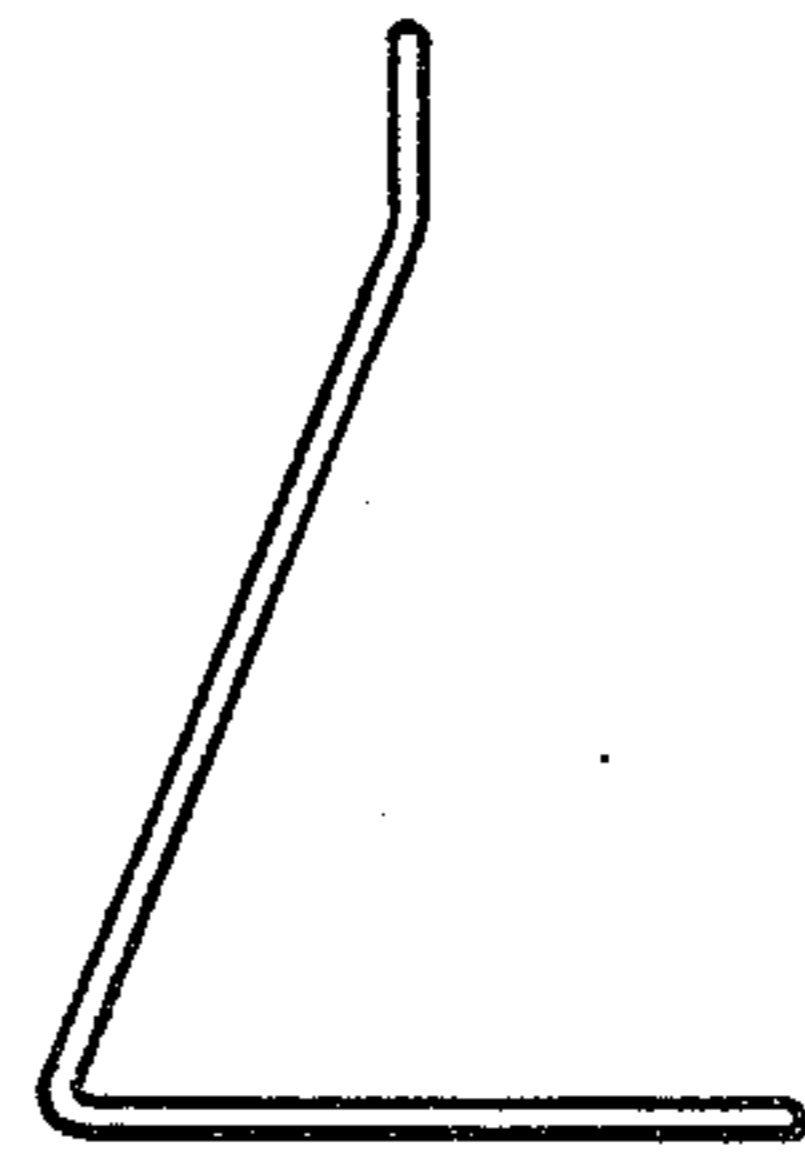




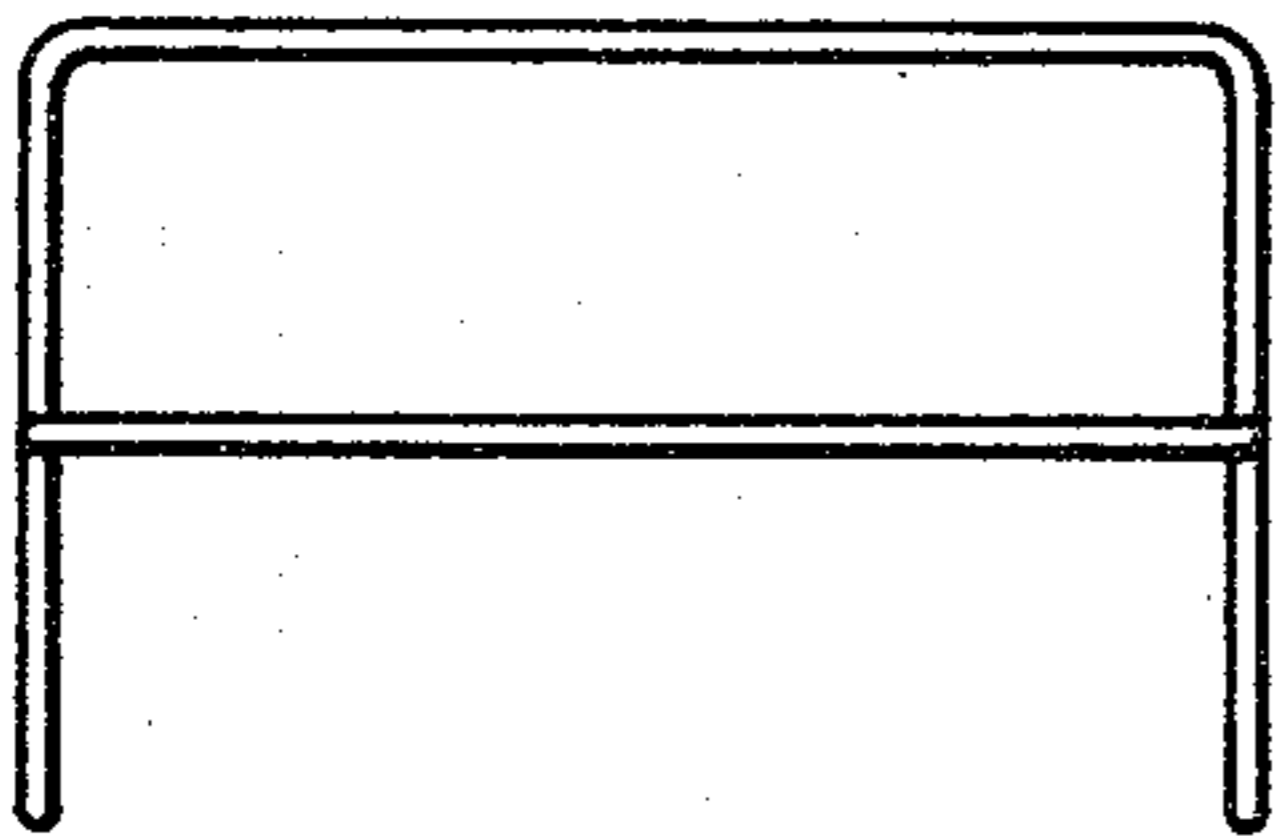
FIG_1



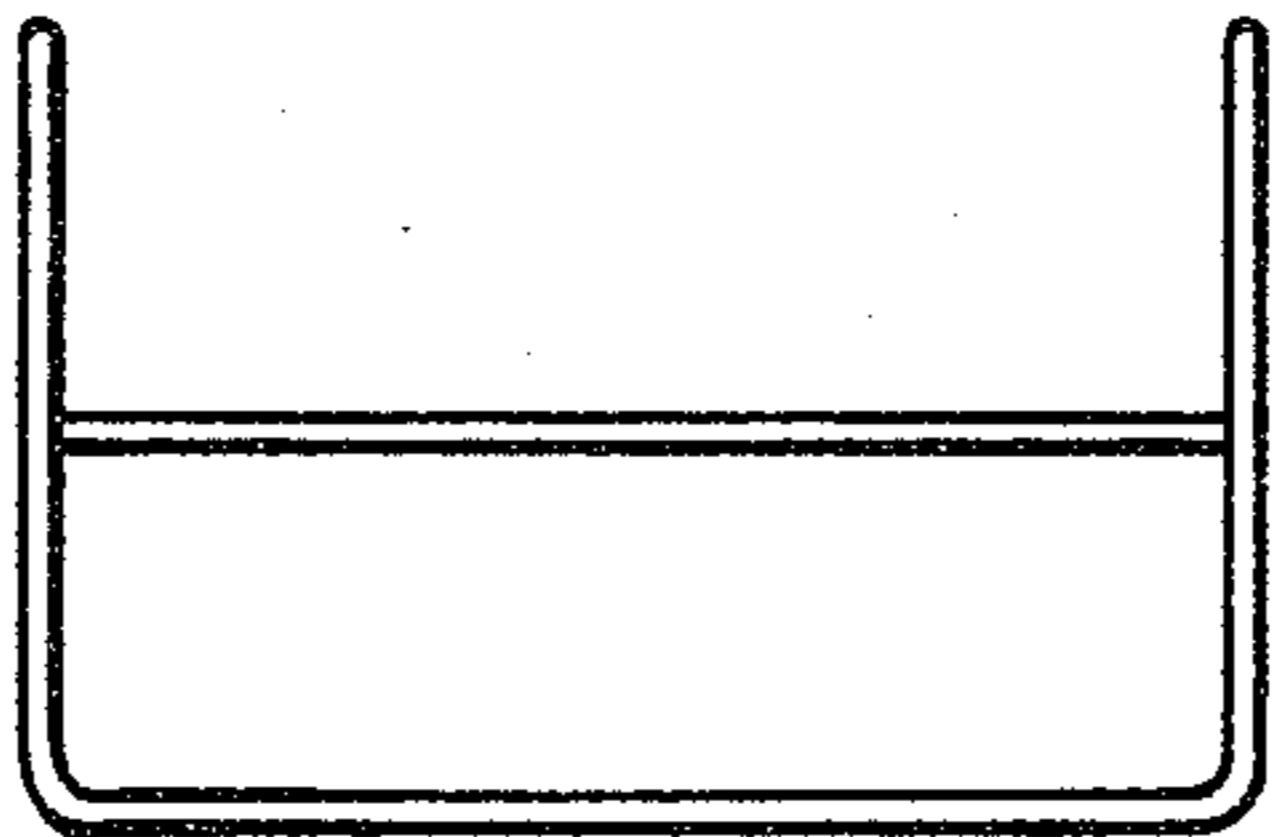
FIG_2



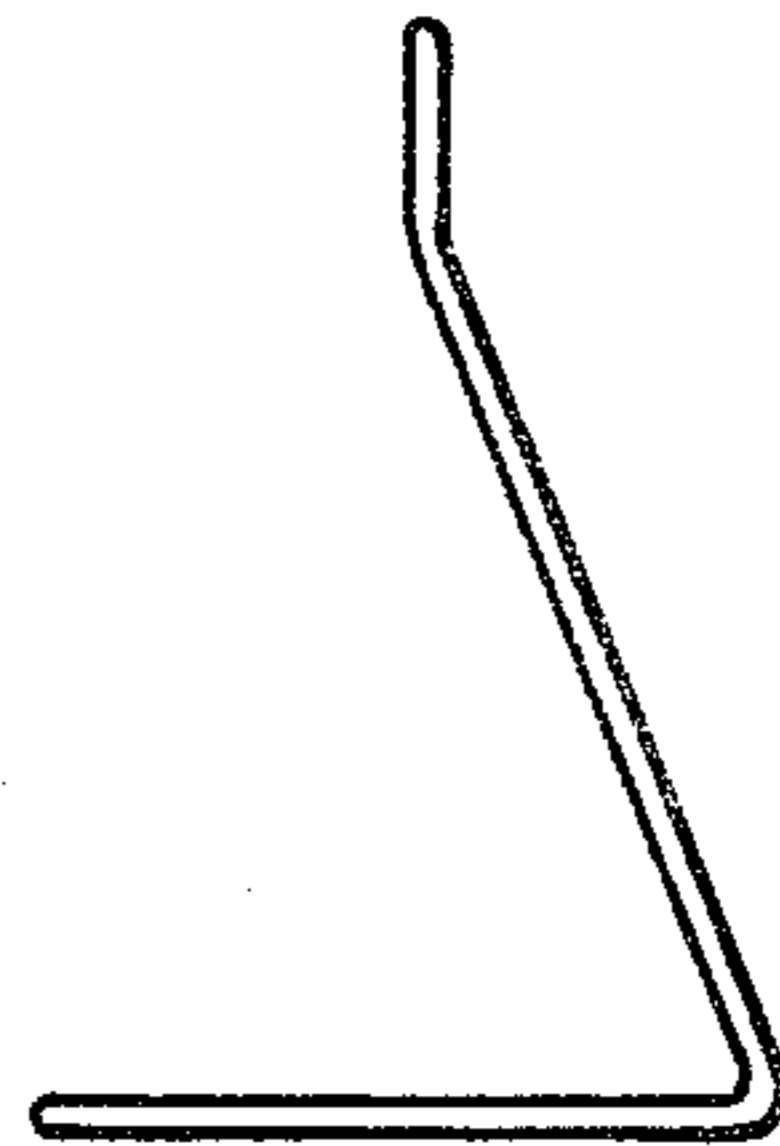
FIG_3



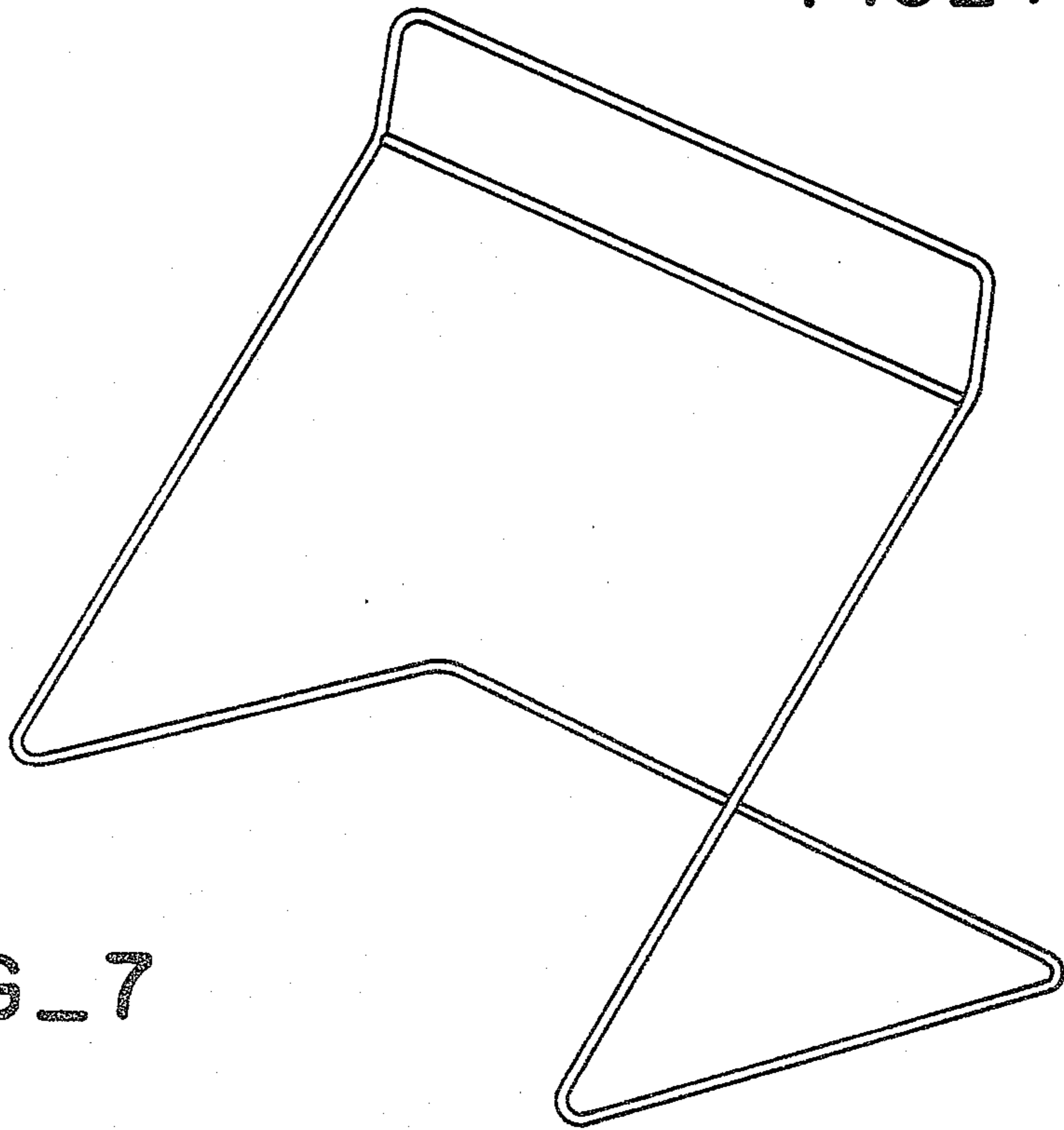
FIG_5



FIG_6



FIG_4



FIG_7