

[54] TELEPHONE

[75] Inventor: Ronald C. Banko, North Wales, Pa.

[73] Assignee: Comdial Telephone Systems, Inc.,
Charlottesville, Va.

[**] Term: 14 Years

[21] Appl. No.: 461,574

[22] Filed: Jan. 27, 1983

[52] U.S. Cl. D14/58; D14/53;
D14/56

[58] Field of Search D14/52, 53, 100, 54,
D14/106, 58, 59, 60, 61, 62; 179/179, 178, 90
K, 100 R, 100 C, 100 D, 100 L, 101, 146 R, 147

[56] References Cited

U.S. PATENT DOCUMENTS

D. 248,300	6/1978	Hirasawa et al.	D14/53
D. 257,772	1/1981	Fukutani	D14/58
D. 266,667	10/1982	Bel	D14/58
D. 269,089	5/1983	Foggia et al.	D14/53
D. 269,674	7/1983	Hirota et al.	D14/53
D. 273,108	3/1984	Breger	D14/58

OTHER PUBLICATIONS

C & P brochure/AT&T Phone Center Phones, printed 3/77; Deskphone p. 2, bottom, 3rd phone from left end. Paper by Furlita et al: "Model S-1P Loudspeaker Telephone Set Design", 1979; p. 489.

Primary Examiner—Wallace R. Burke
Assistant Examiner—Horace B. Fay
Attorney, Agent, or Firm—Christie, Parker & Hale

[57] CLAIM

The ornamental design for a telephone, substantially as shown and described.

DESCRIPTION

FIG. 1 is an isometric view of a desk top embodiment of a telephone showing my new design with the handset off hook;

FIG. 2 is a top plan view thereof with the handset off hook;

FIG. 3 is a top plan view thereof with the handset on hook;

FIGS. 4 and 5 are respectively front elevational views of the design as illustrated in FIGS. 2 and 3;

FIGS. 6 and 7 are respectively right and left side elevational views of the design as illustrated in FIG. 3;

FIG. 8 is a rear elevational view of the design as illustrated in FIG. 3;

FIG. 9 is an isometric view looking towards the top and right side of an upright second embodiment of the telephone design intended for wall mounting;

FIG. 10 is a top plan view of the second embodiment with the handset on hook;

FIGS. 11 and 12 are left and right side elevational views of the second embodiment as shown in FIG. 10; and

FIG. 13 is a bottom plan view of the second embodiment with the handset on hook.

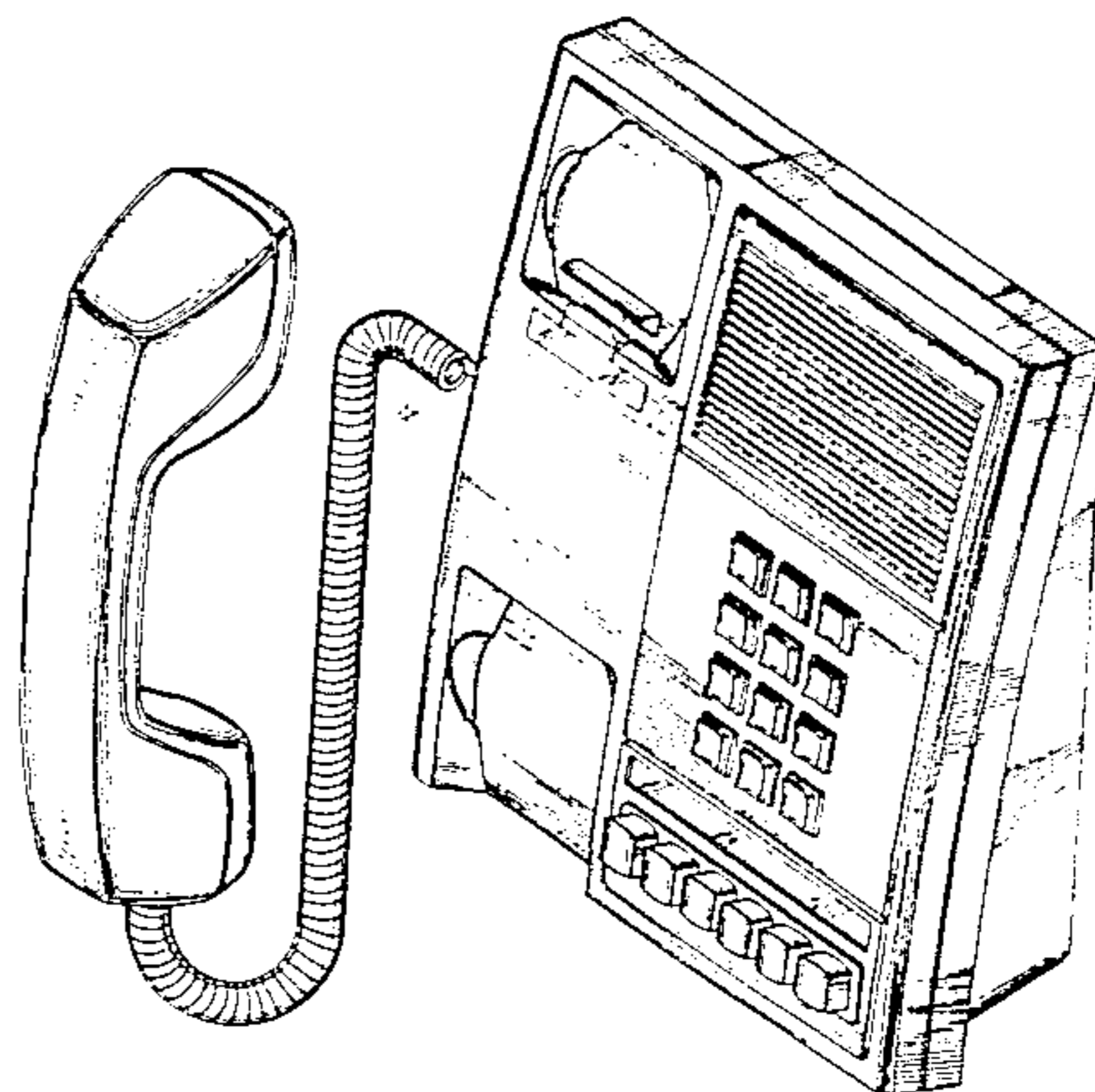
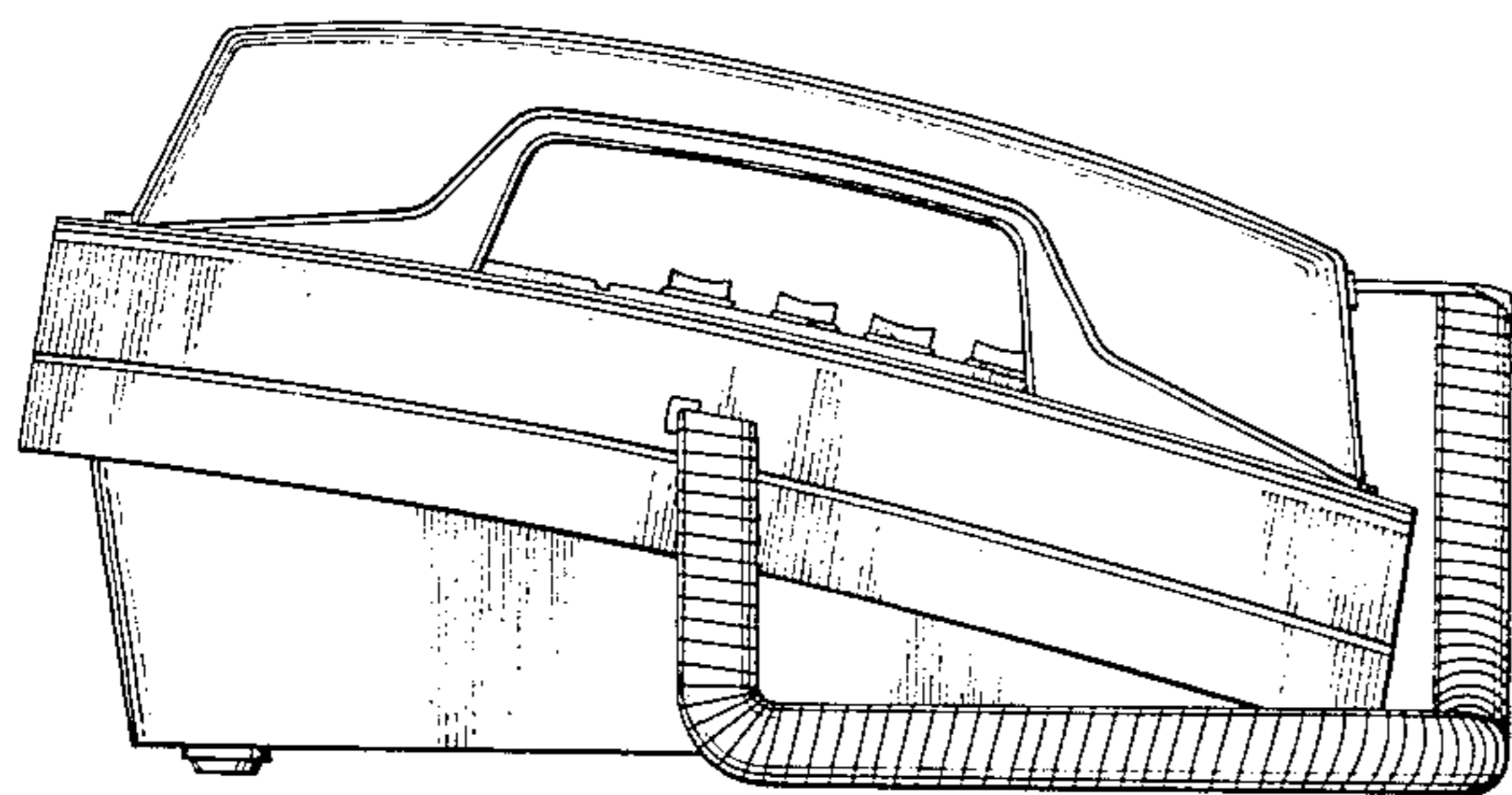

Fig. 1.

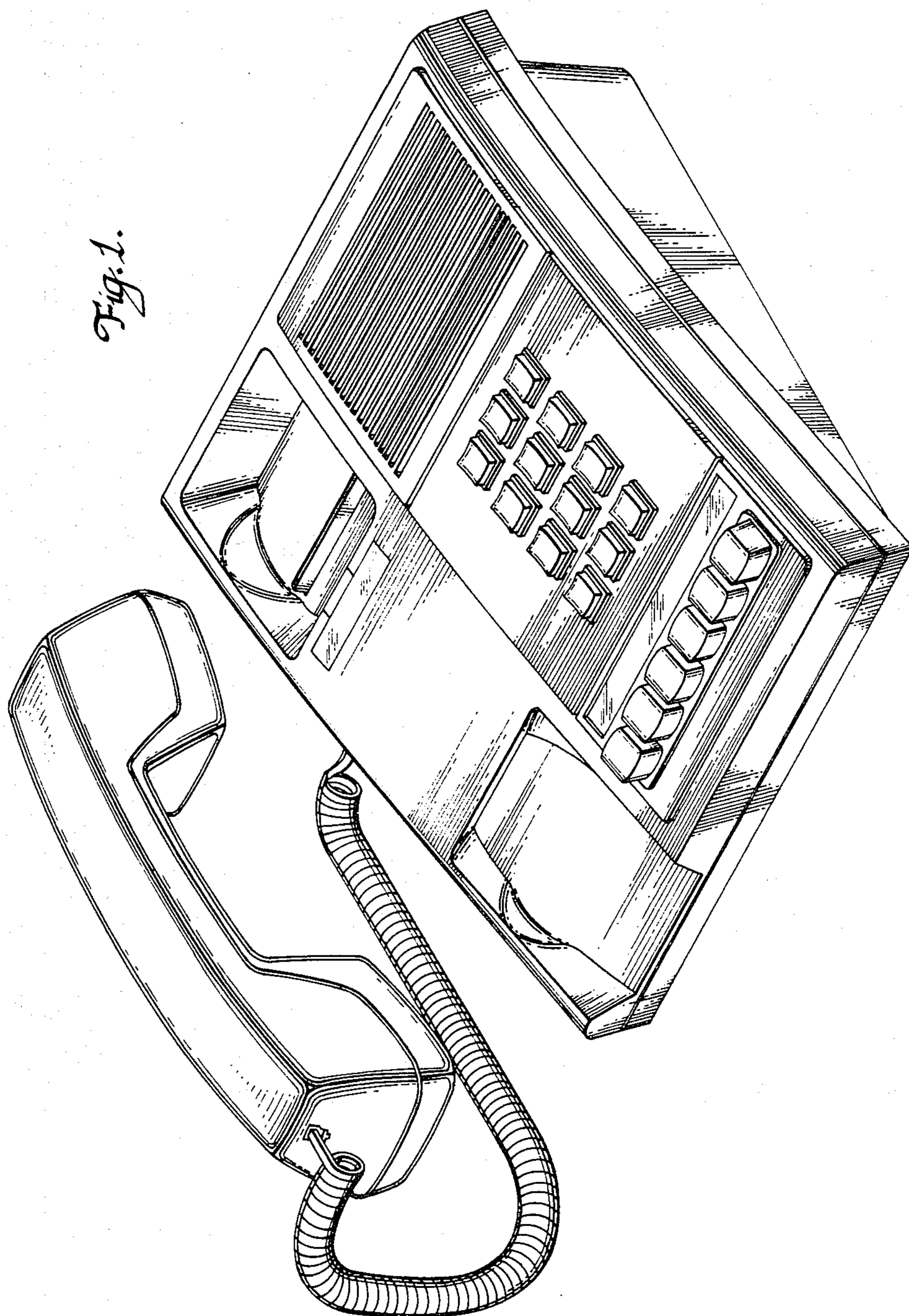

Fig. 2.

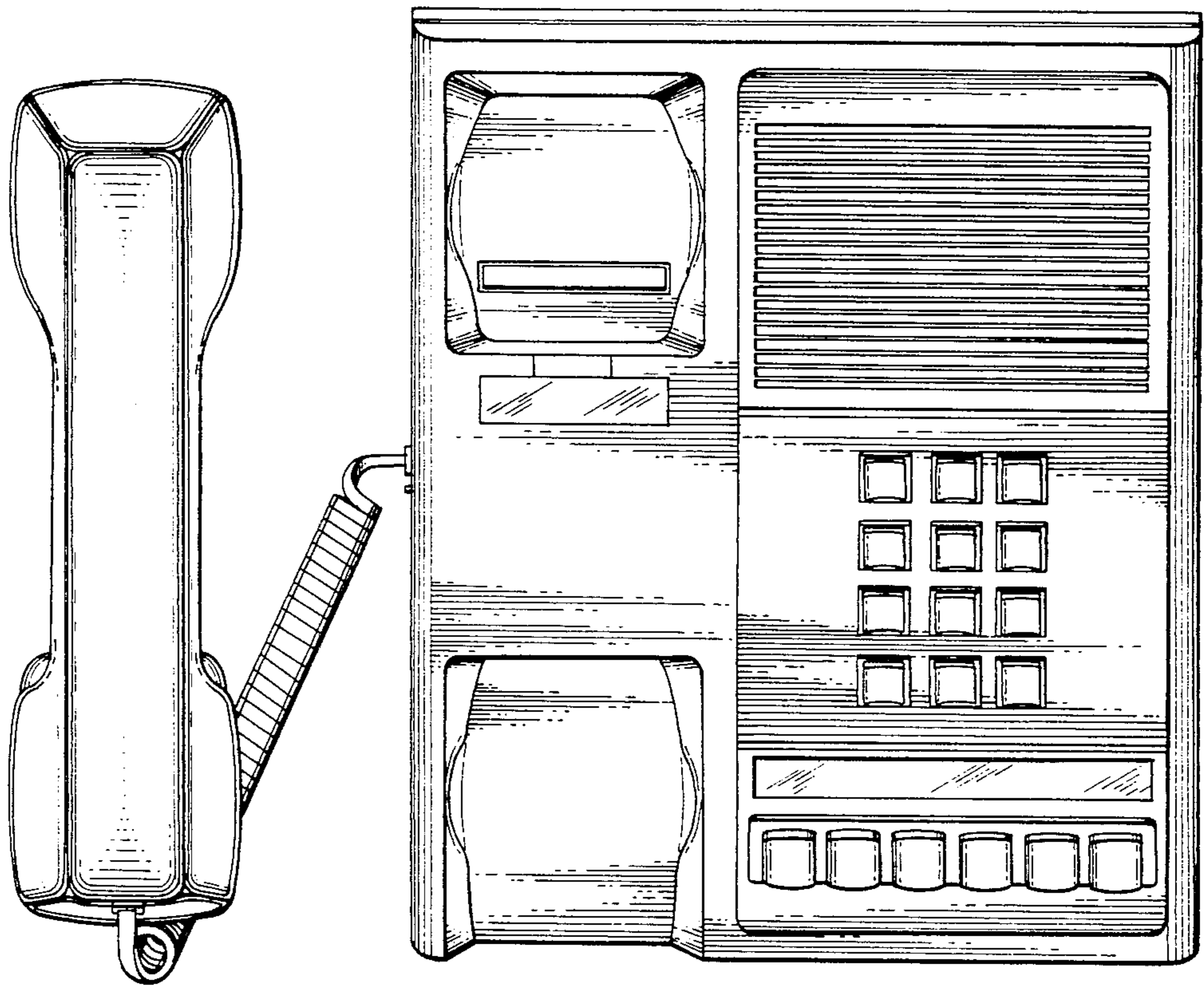

Fig. A.

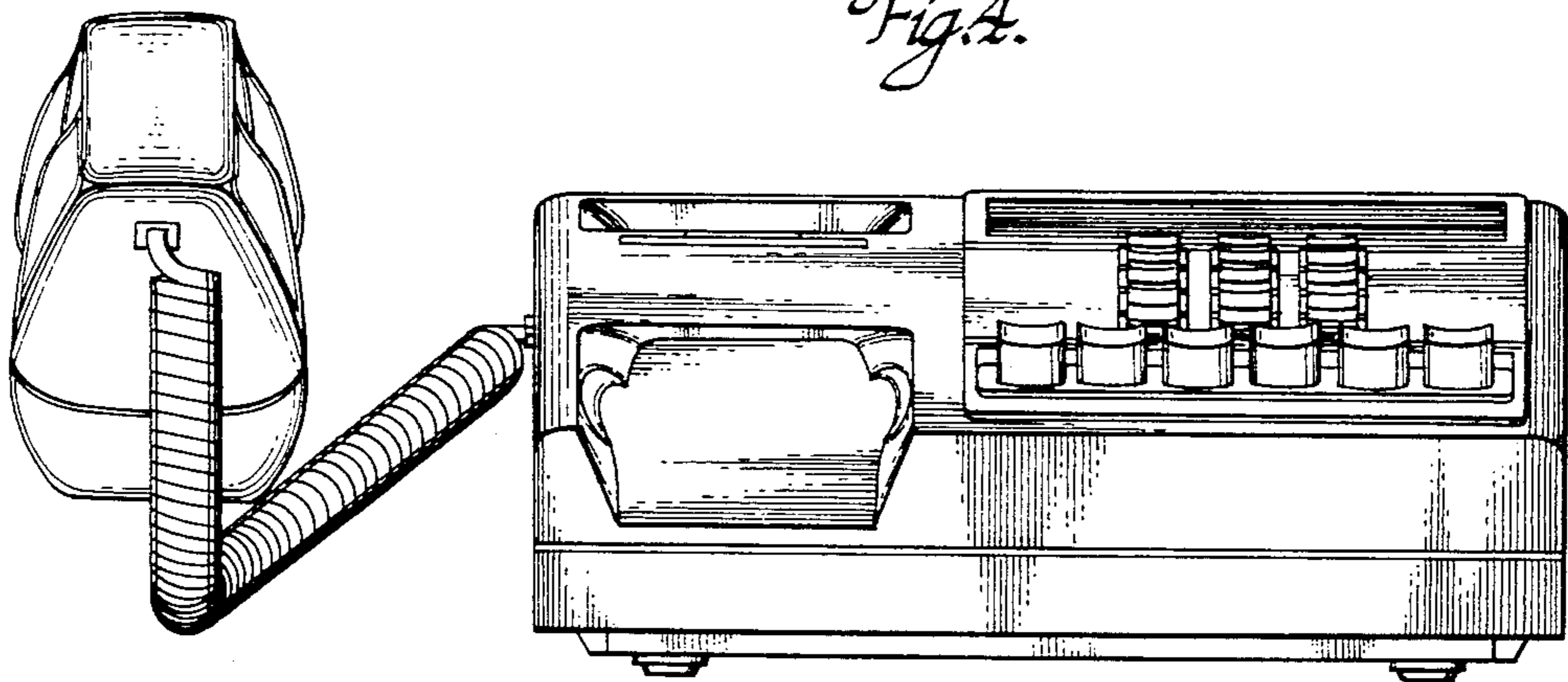

Fig. 3.

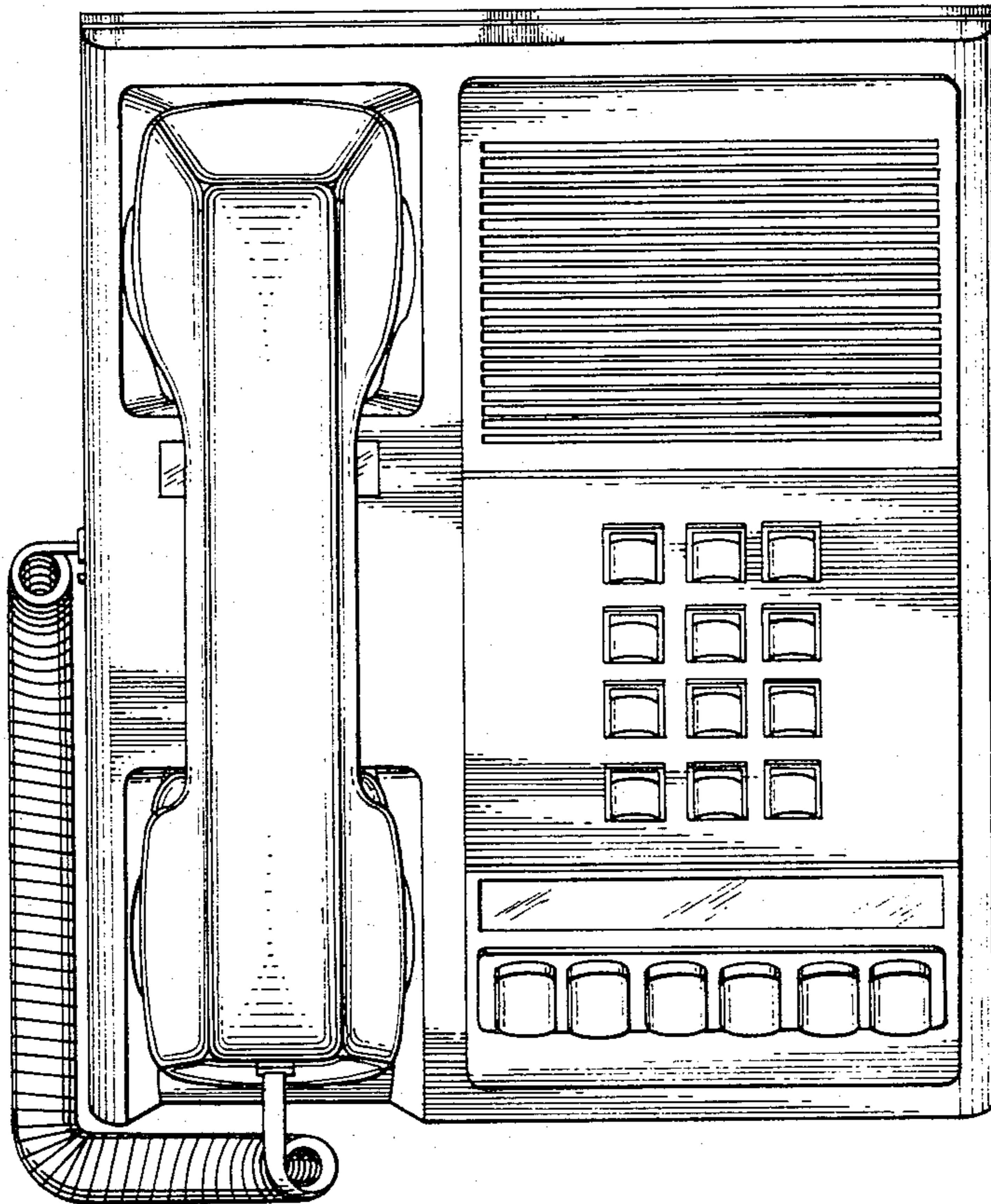

Fig. 5.

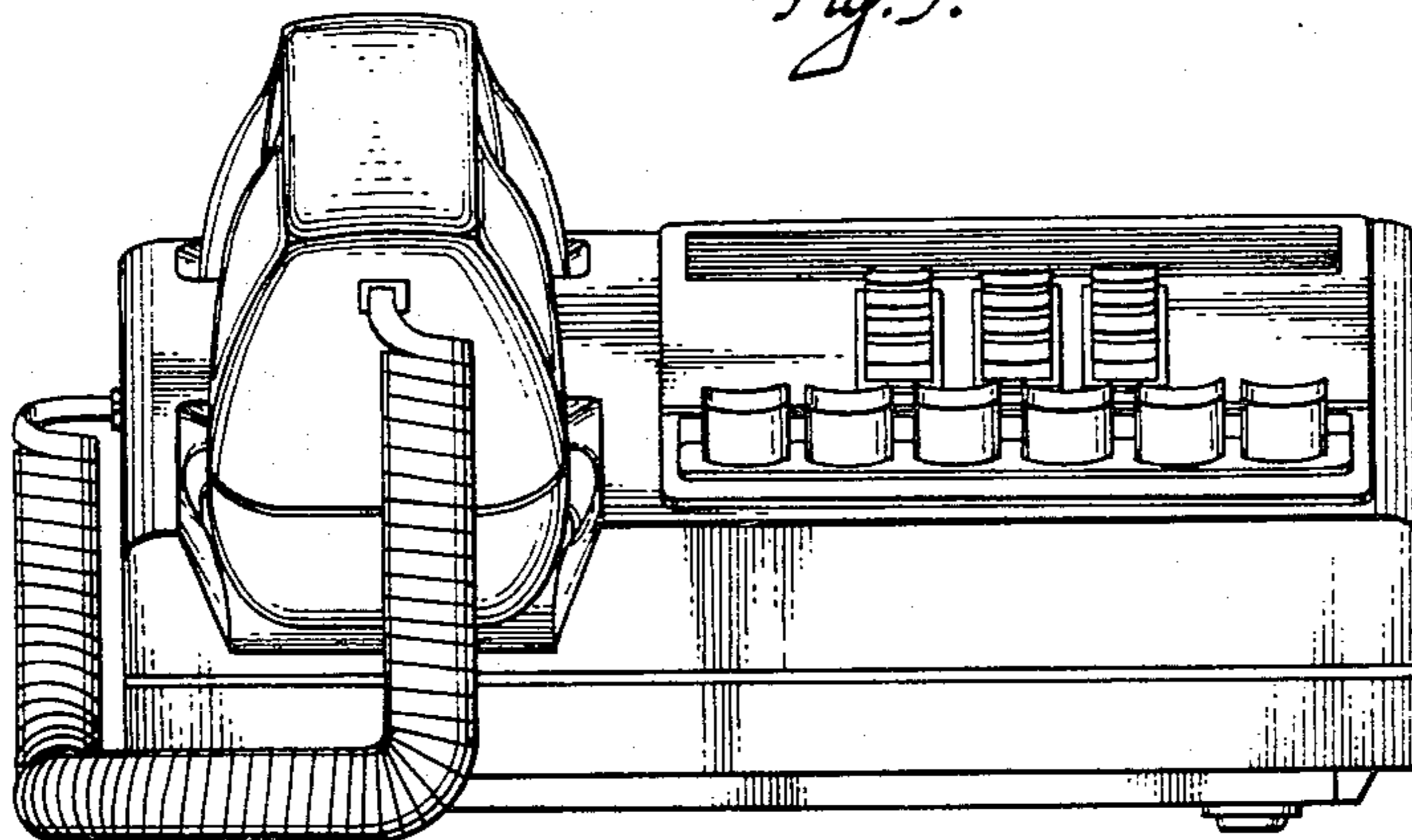

Fig. 6.

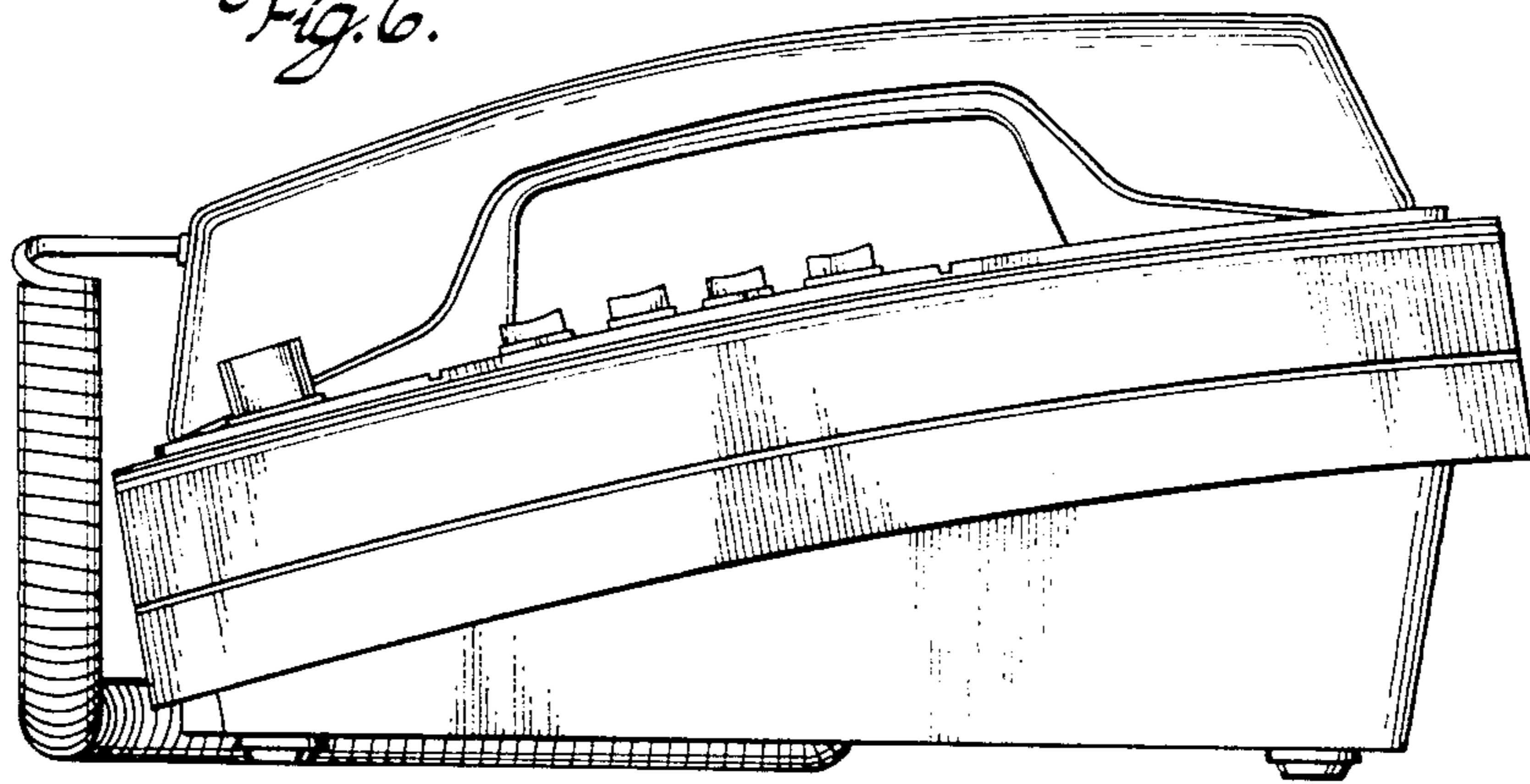

Fig. 7.

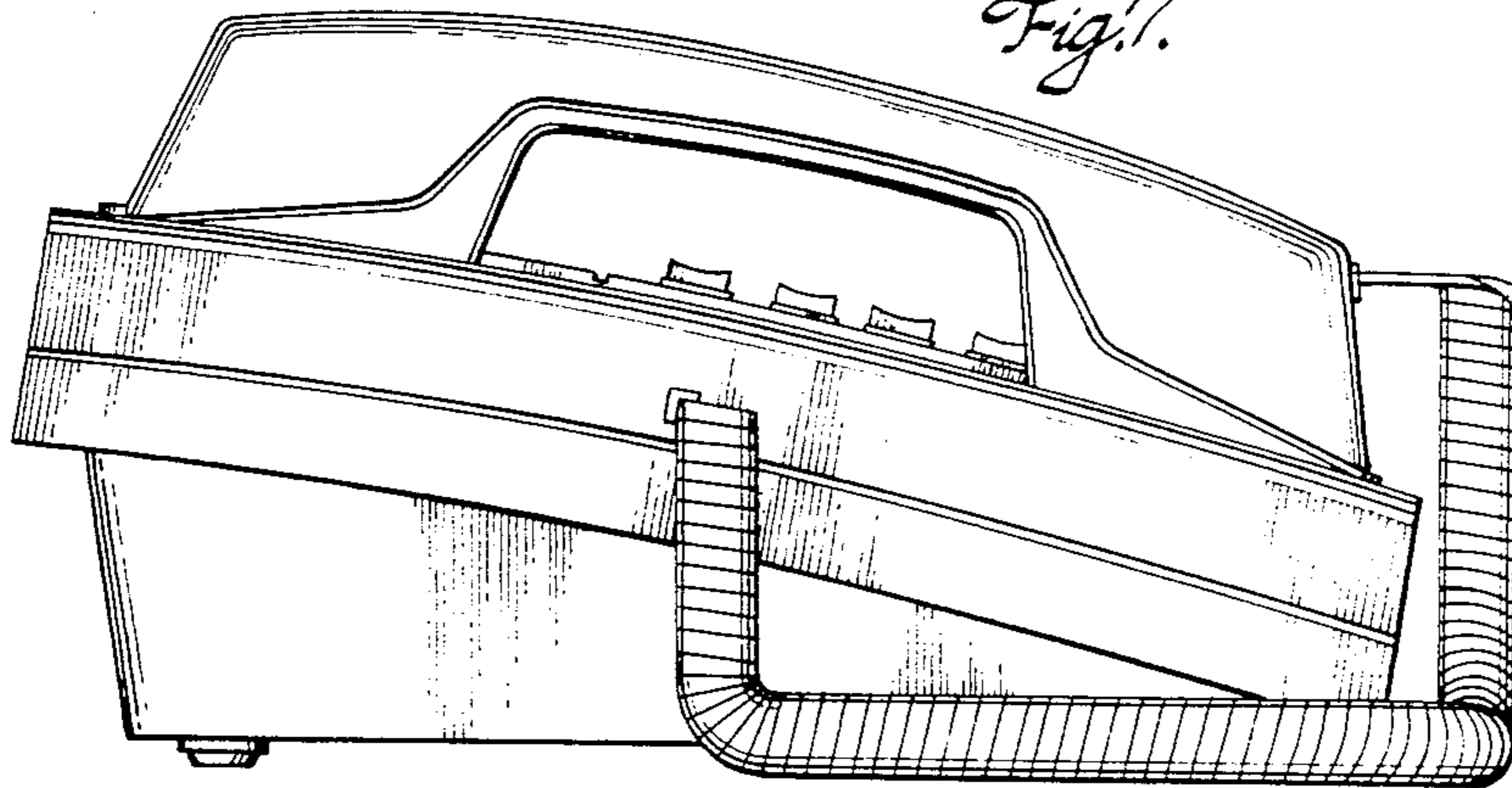
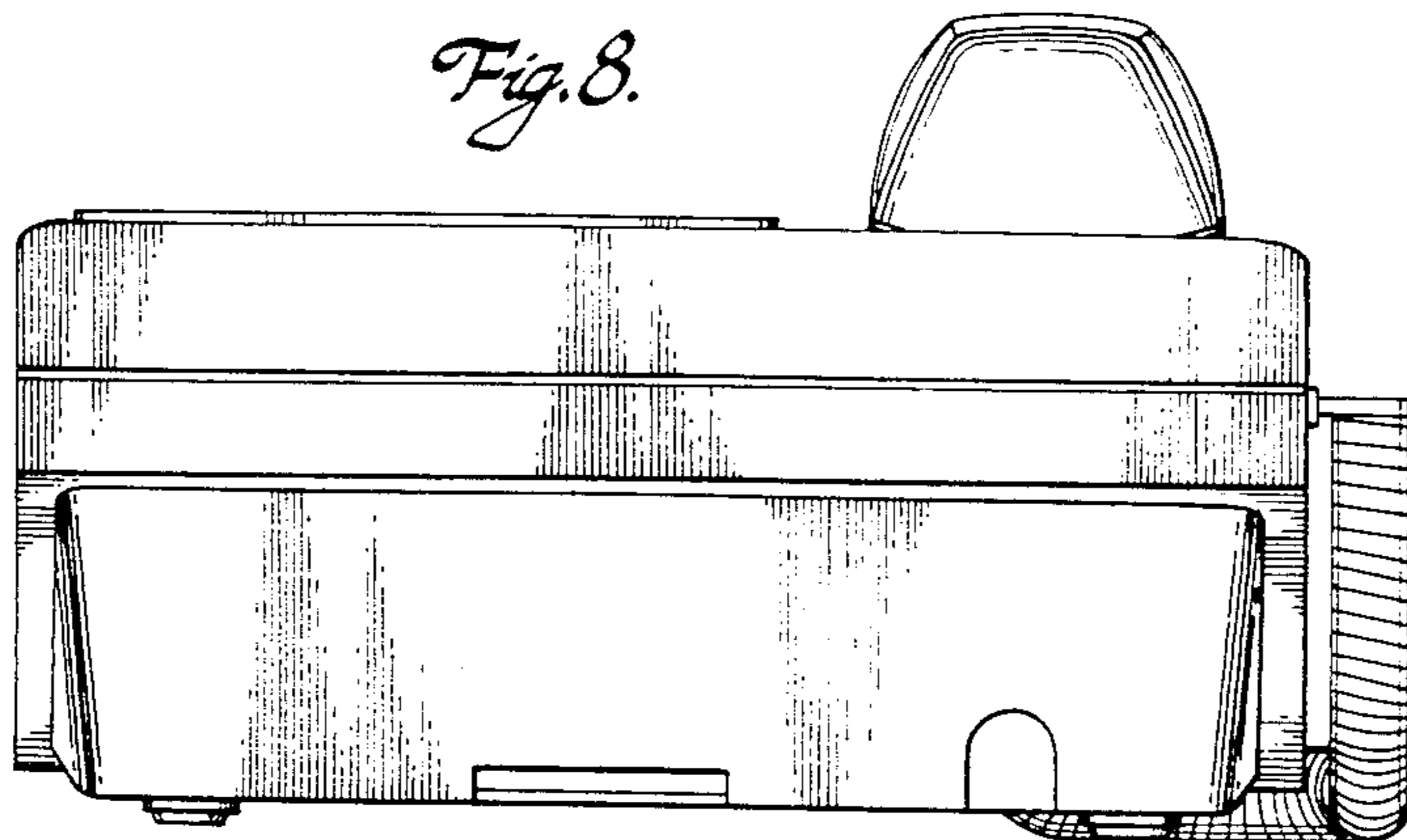

Fig. 8.



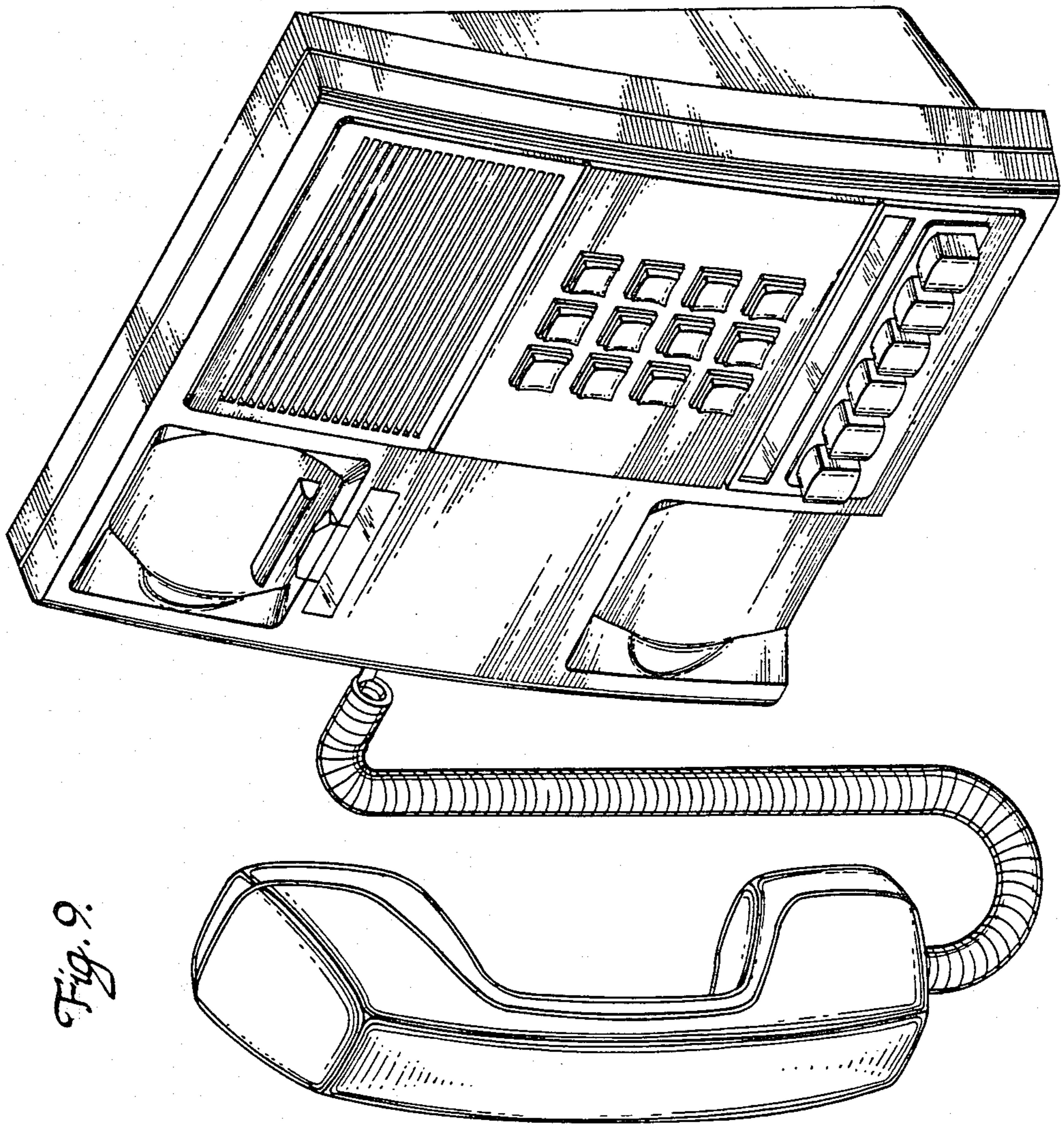

Fig. 9.

Fig. 10.

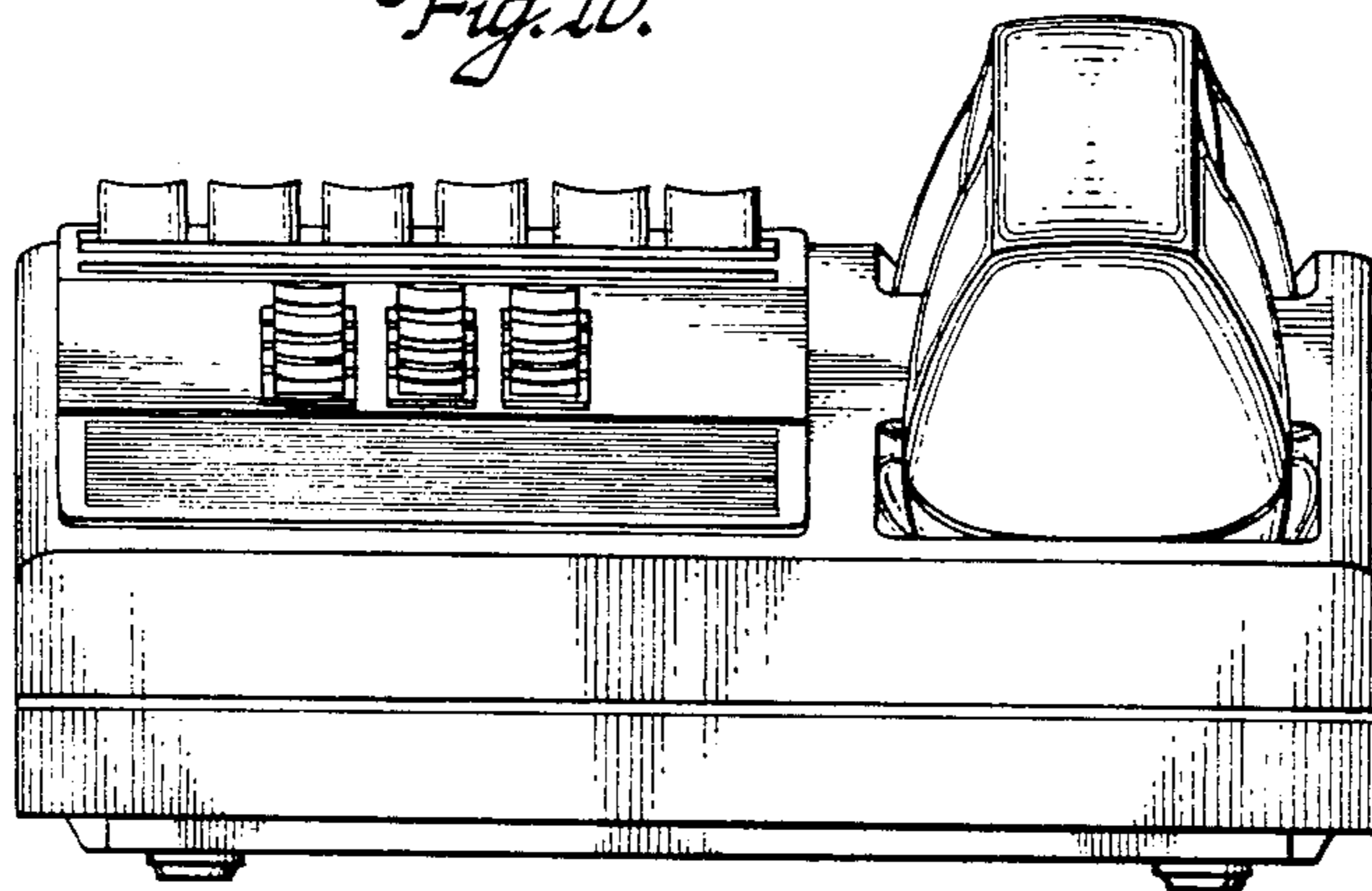
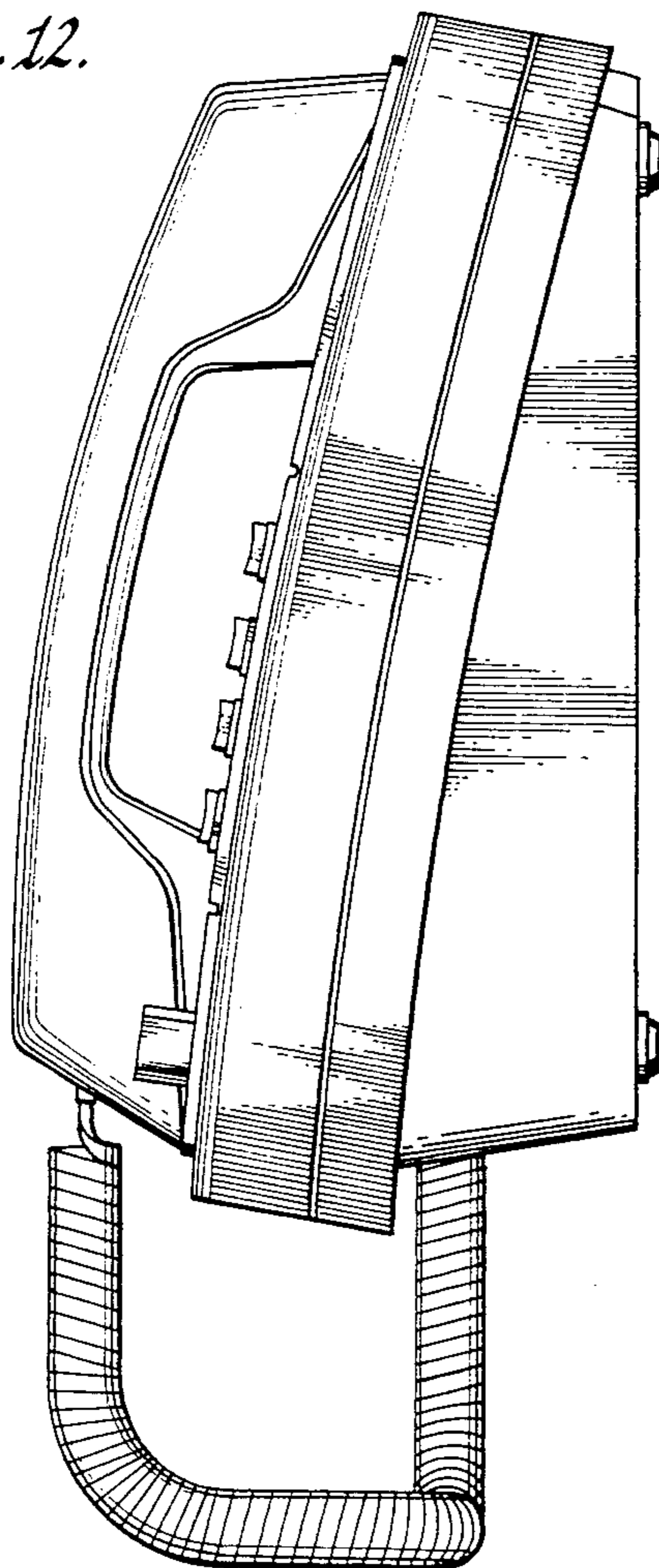

Fig. 12.



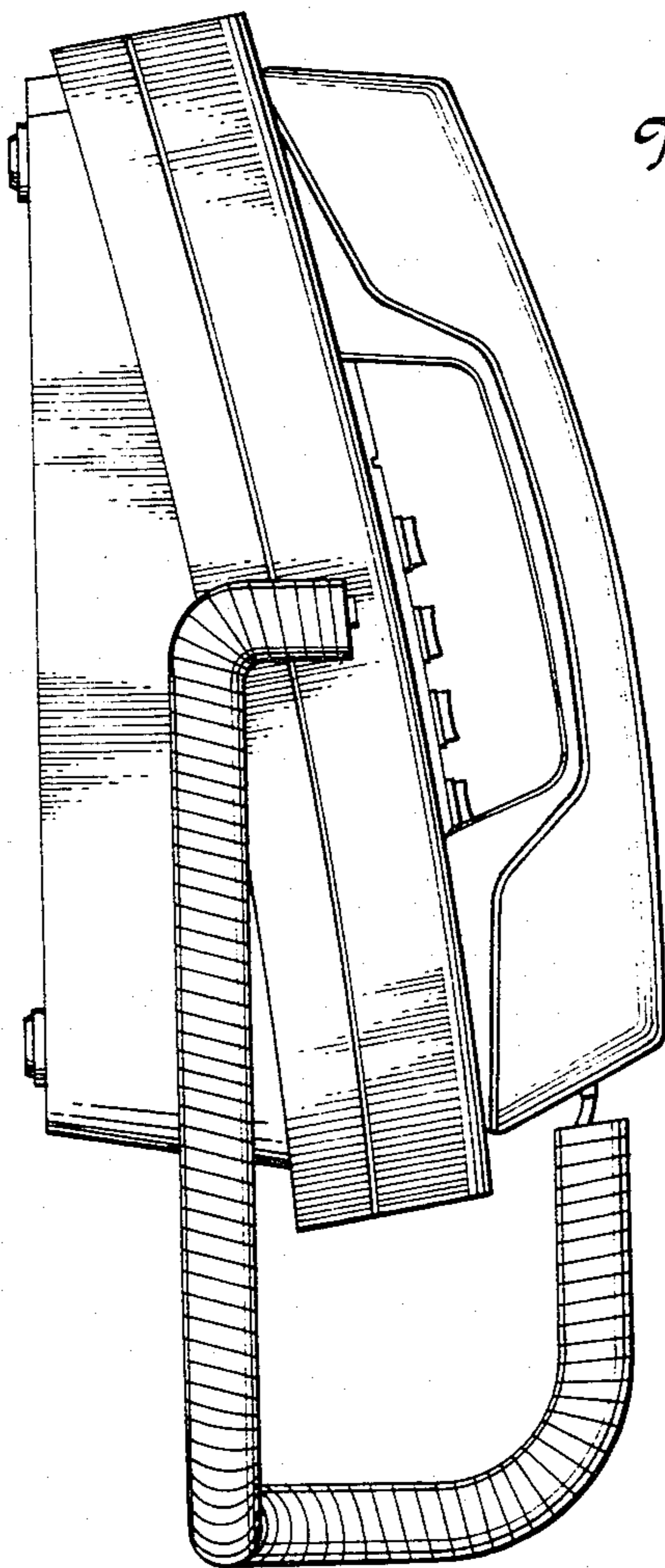

Fig. 11.

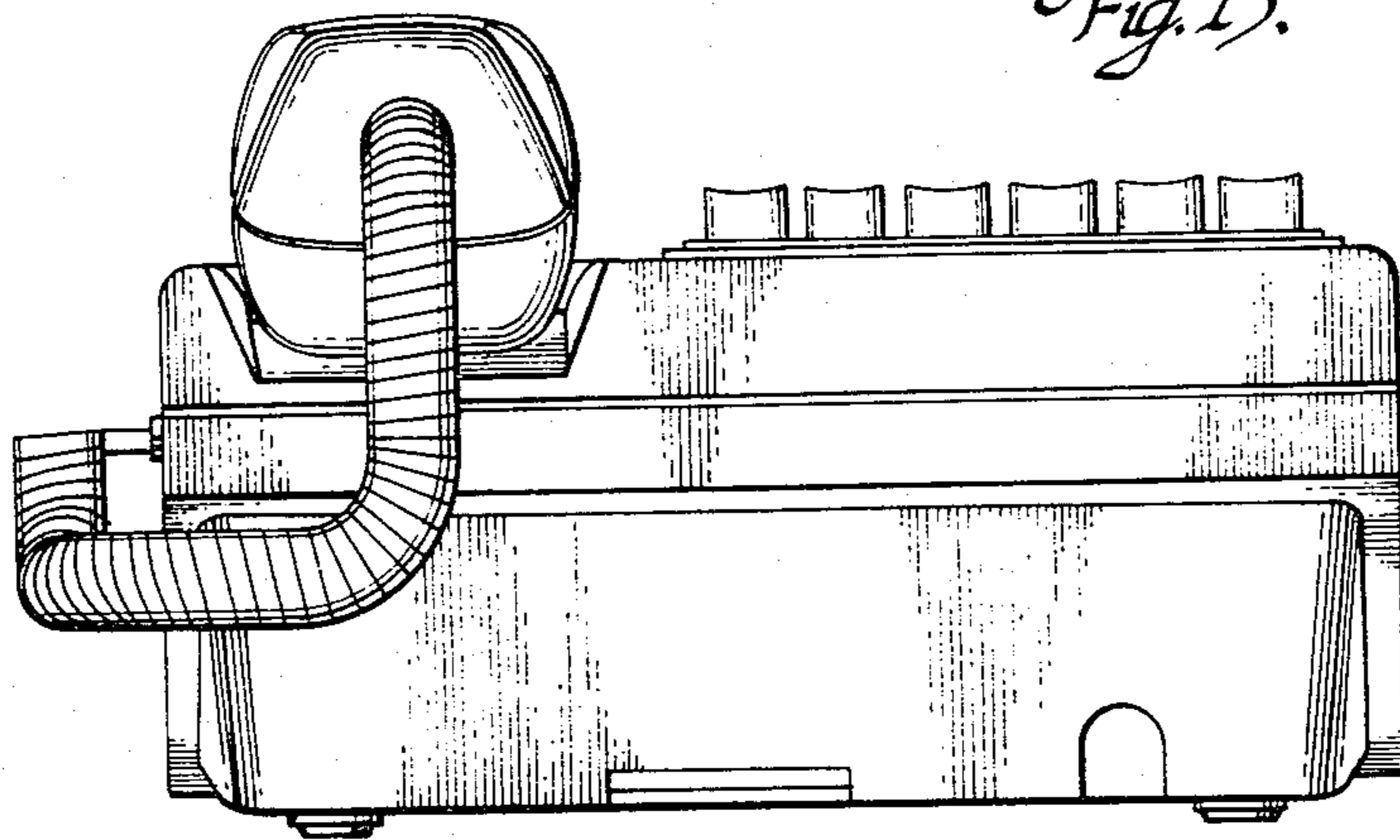

Fig. 13.