

[54] **MOTORCYCLE RADIO HOUSING**

D. 263,577 3/1982 Hoese D12/114

[76] Inventor: **Fred O. Hoese**, 30706 Wildcat Dr.,
Bulverde, Tex. 78163

Primary Examiner—James M. Gandy
Attorney, Agent, or Firm—John C. Stahl

[**] Term: **14 Years**

[57] **CLAIM**

[21] Appl. No.: **382,188**

The ornamental design for a motorcycle radio housing,
as shown.

[22] Filed: **May 26, 1982**

[52] U.S. Cl. **D12/114**

[58] Field of Search D12/114; D14/68;
312/7.1; 280/289 R

DESCRIPTION

FIG. 1 is a top plan view of a motorcycle radio housing,
showing my new design;

FIG. 2 is a front elevational view;

FIG. 3 is a bottom plan view;

FIG. 4 is a rear elevational view;

FIG. 5 is a left side elevational view; and

FIG. 6 is a right side elevational view.

[56] **References Cited**

U.S. PATENT DOCUMENTS

D. 257,967 1/1981 Hoese D12/114

D. 257,971 1/1981 Hoese D12/114

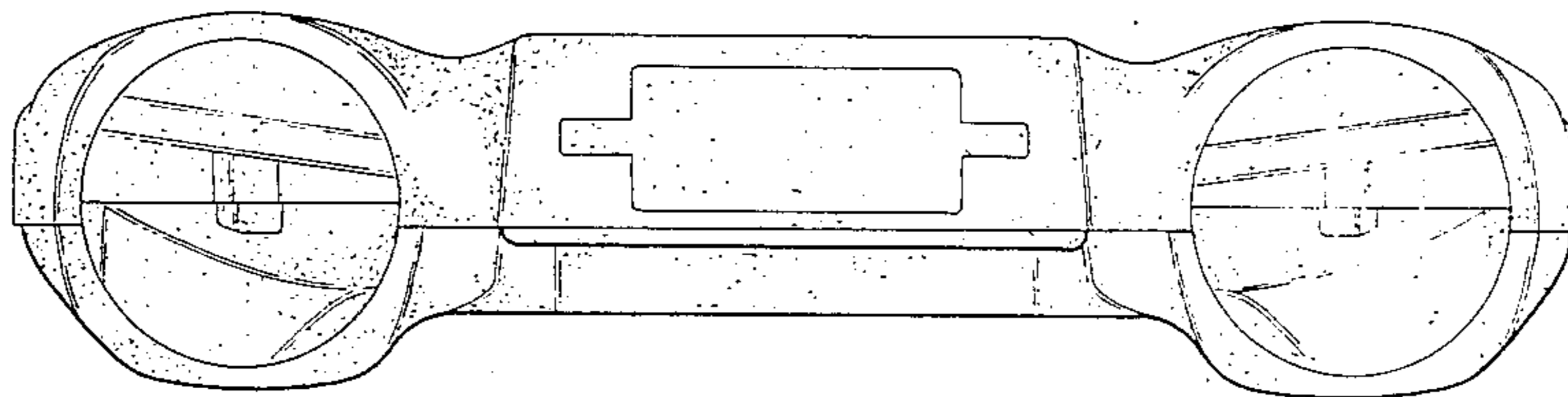
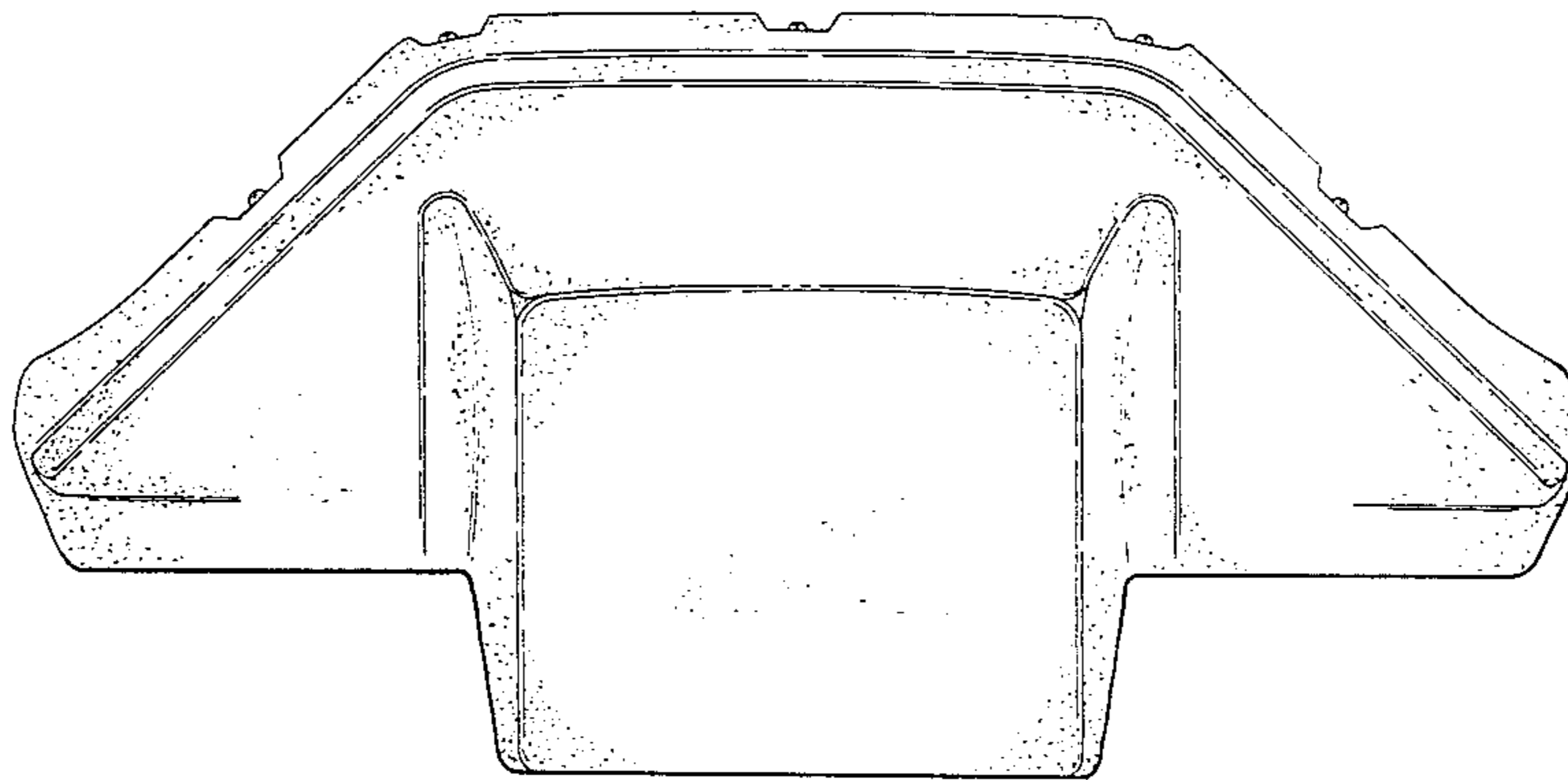

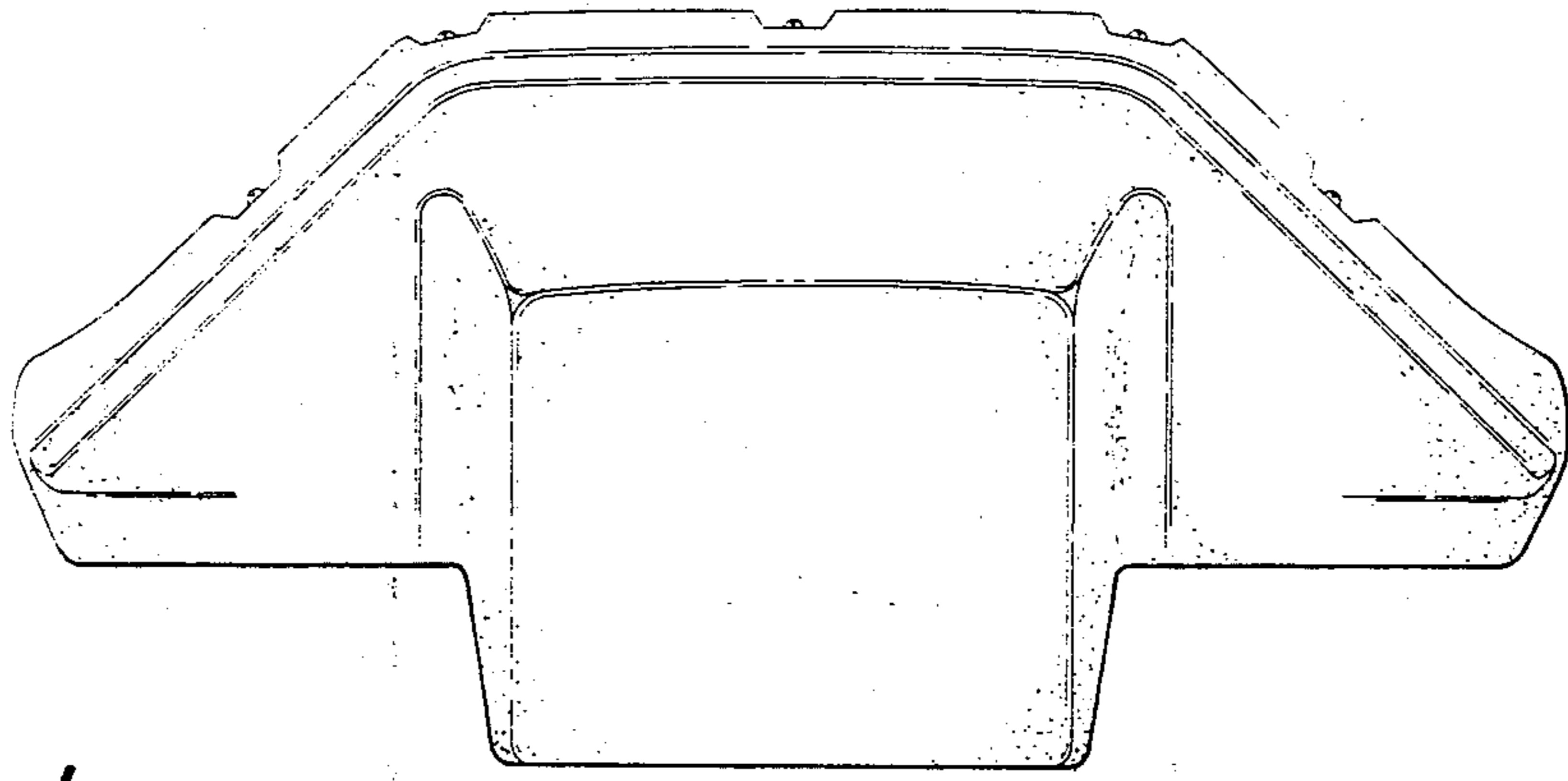

FIG. 1

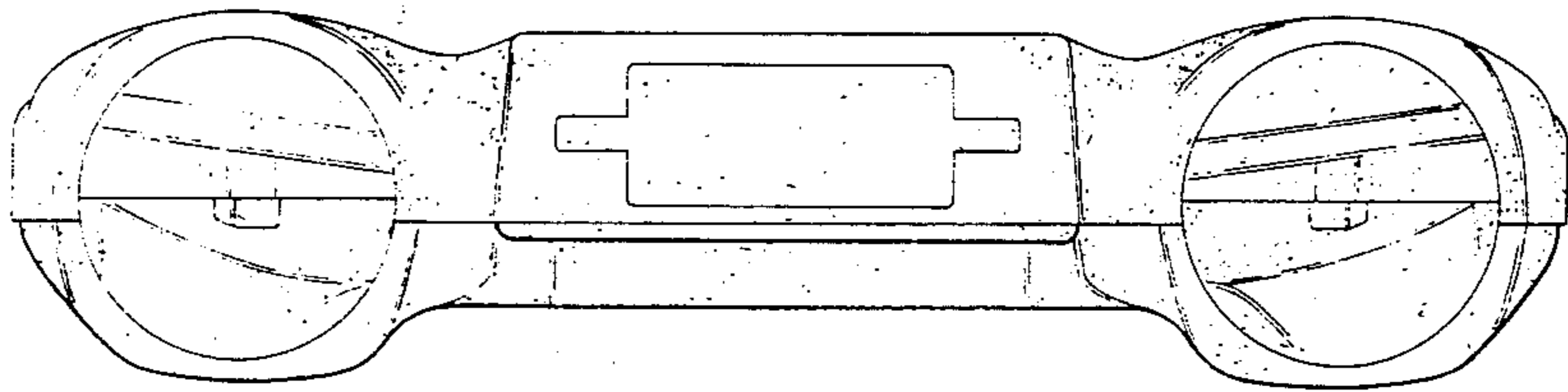

FIG. 2

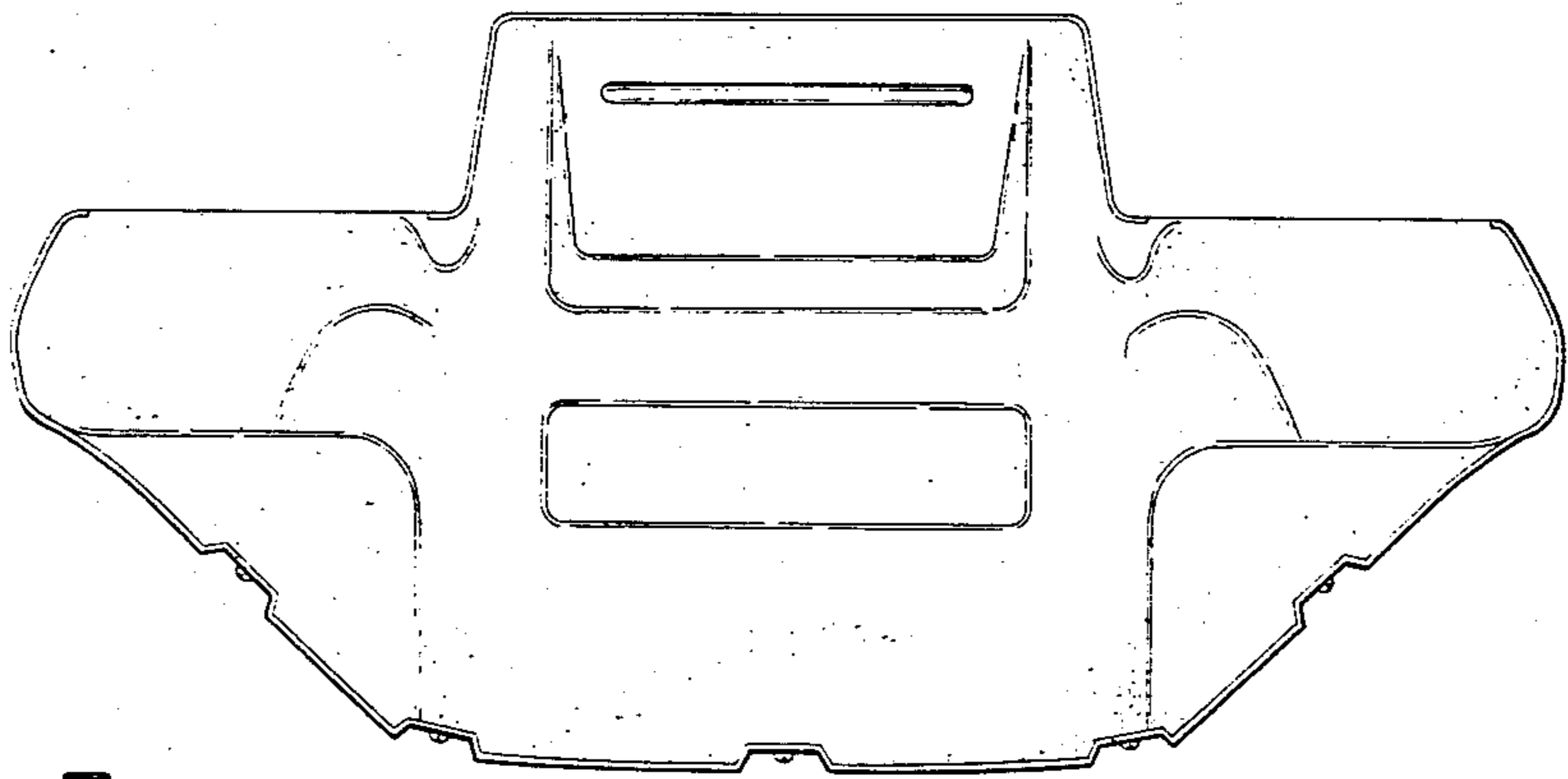

FIG. 3

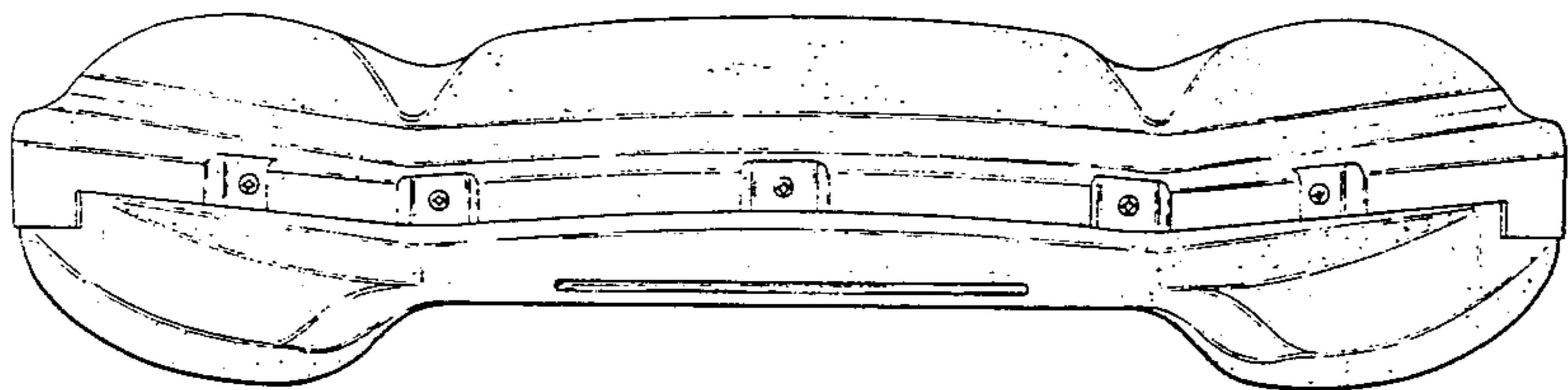

FIG. 4

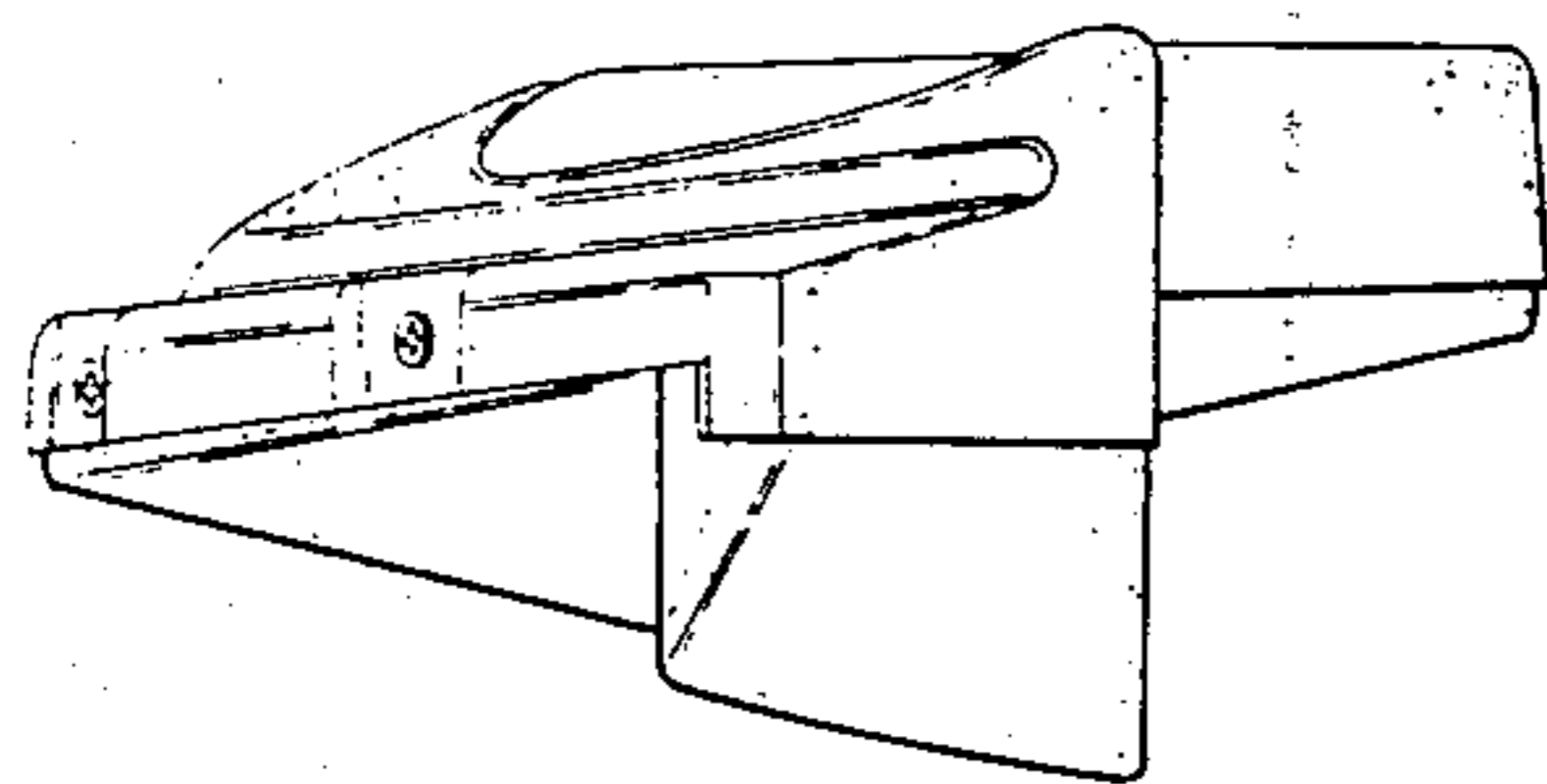

FIG. 5

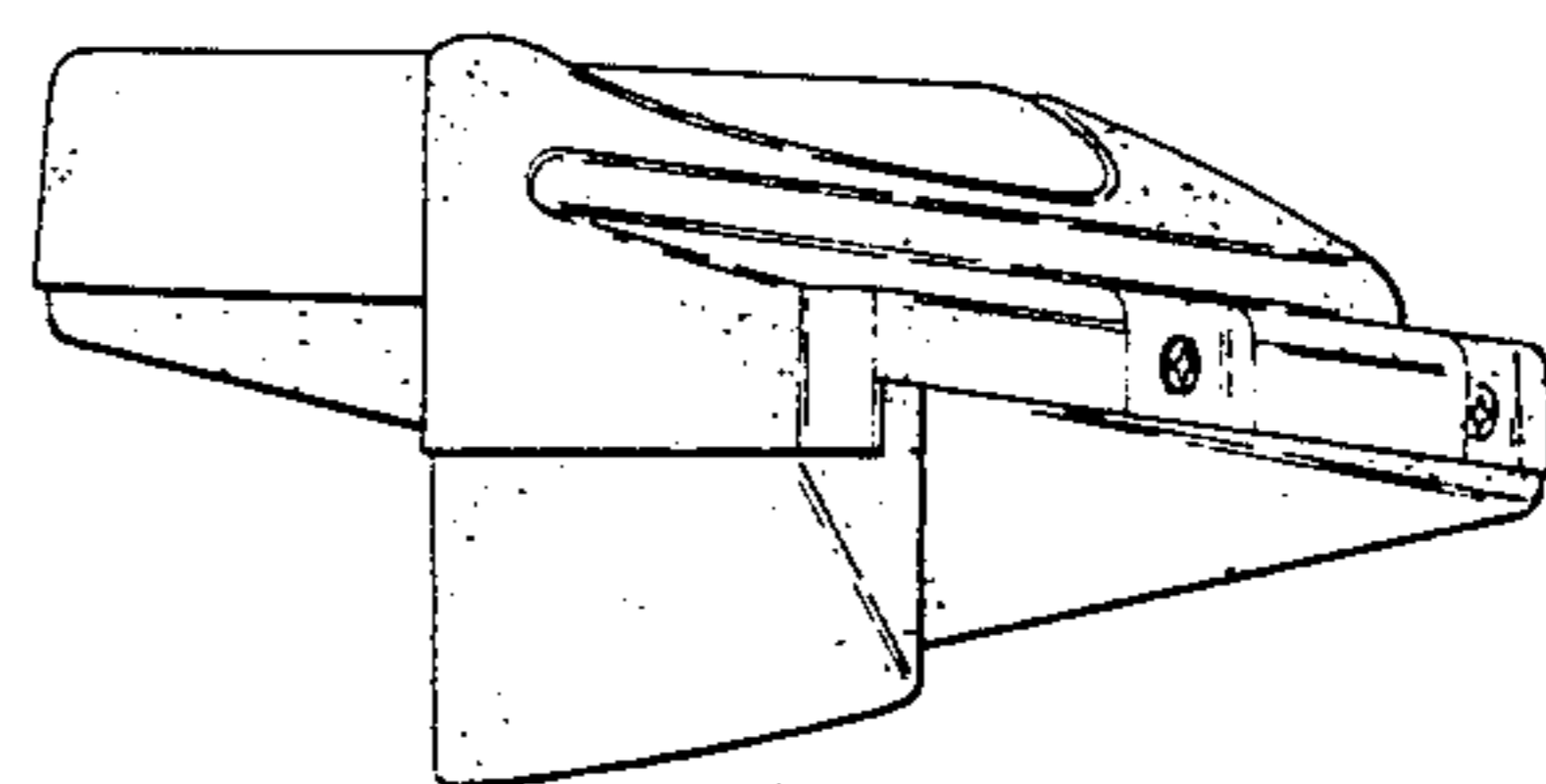

FIG. 6