

[54] LAVATORY SPOUT OR SIMILAR ARTICLE

[75] Inventor: James E. Niemann, Louisville, Ky.

[73] Assignee: American Standard Inc., New York, N.Y.

[**] Term: 14 Years

[21] Appl. No.: 472,799

[22] Filed: Mar. 7, 1983

[52] U.S. Cl. D23/32

[58] Field of Search D23/23-32;
4/191, 192; 137/801; 251/155

[56] References Cited

U.S. PATENT DOCUMENTS

D. 202,095 8/1965 Kelly D23/32
3,801,997 4/1974 Ward 4/191

OTHER PUBLICATIONS

Bathroom Jewelry Inc. Brochure.

Dornbracht Brochure, printed 9/14/80, pp. 1-5.

Primary Examiner—James R. Largen
Attorney, Agent, or Firm—James J. Salerno, Jr.; Robert G. Crooks; John P. Sinnott

[57] CLAIM

The ornamental design for a lavatory spout or similar article, substantially as shown and described.

DESCRIPTION

FIG. 1 is a perspective view of a lavatory spout embodying my new design;
FIG. 2 is a right side elevational view thereof, the left side being a mirror image of the right side shown;
FIG. 3 is a top view thereof;
FIG. 4 is a bottom view thereof;
FIG. 5 is a front view thereof;
FIG. 6 is a rear view thereof;
FIG. 7 is a cross sectional view taken on line 7—7 of FIG. 2; and
FIG. 8 is a cross sectional view taken on line 8—8 of FIG. 2.

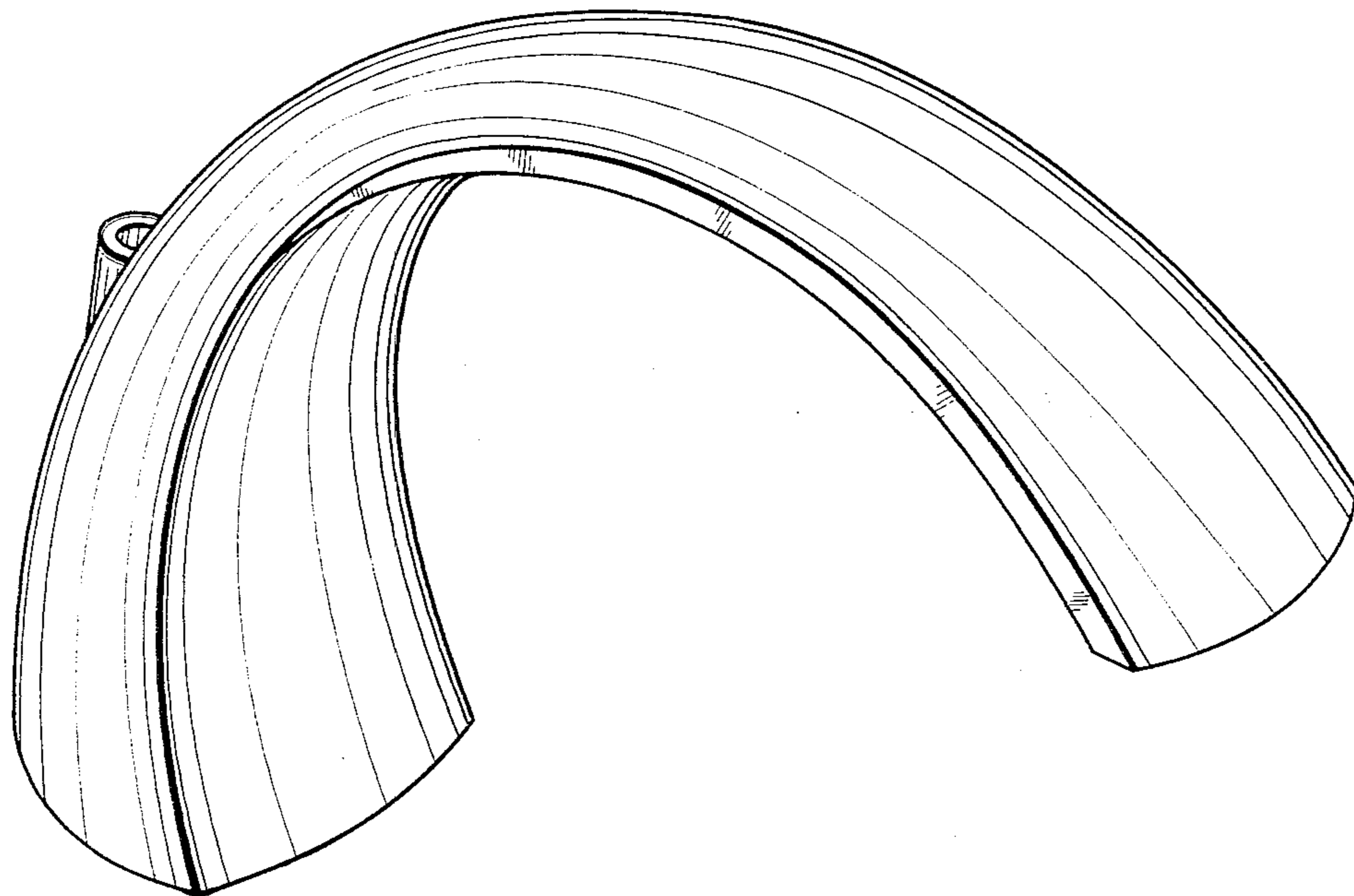

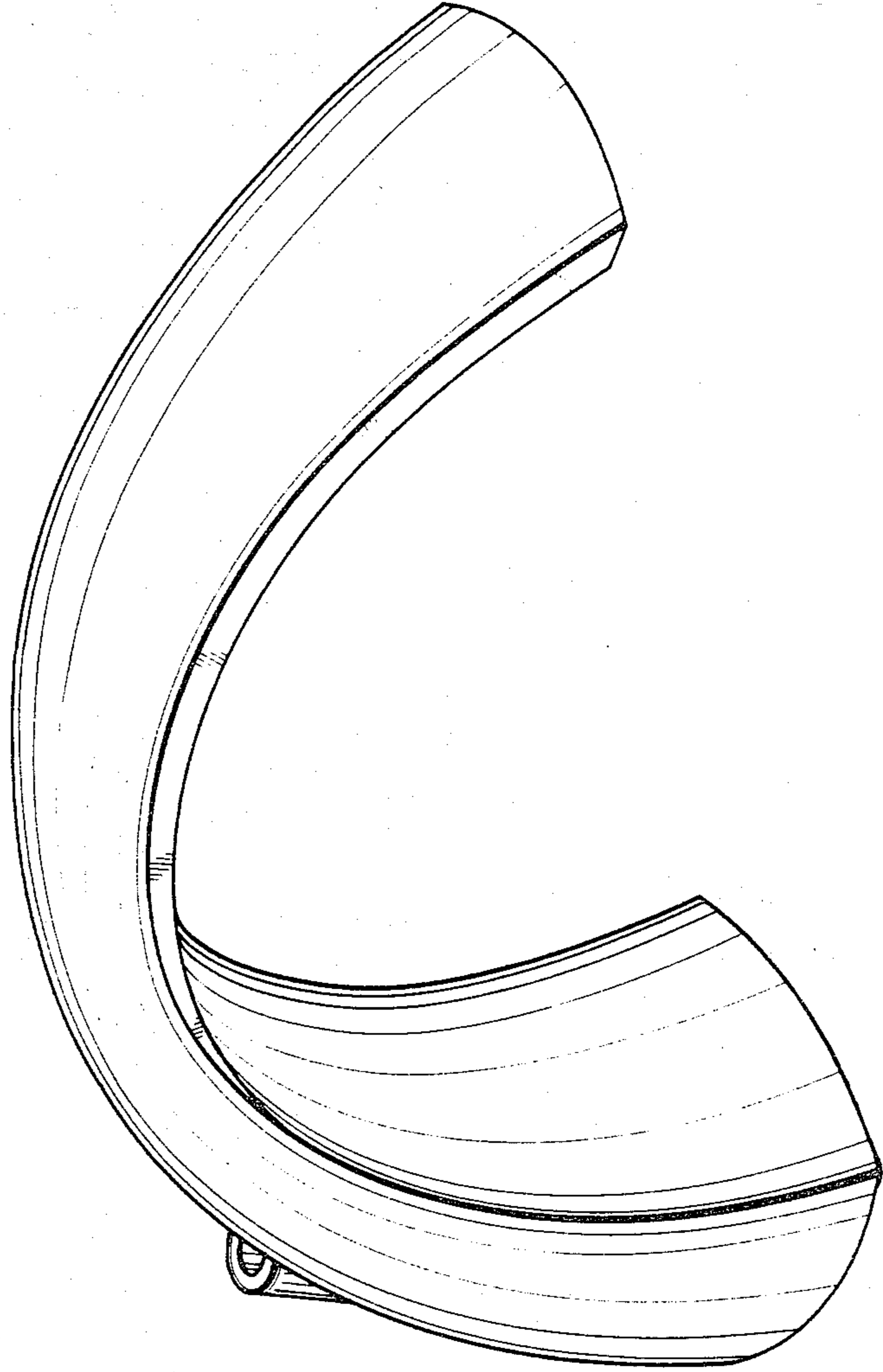

FIG. 1

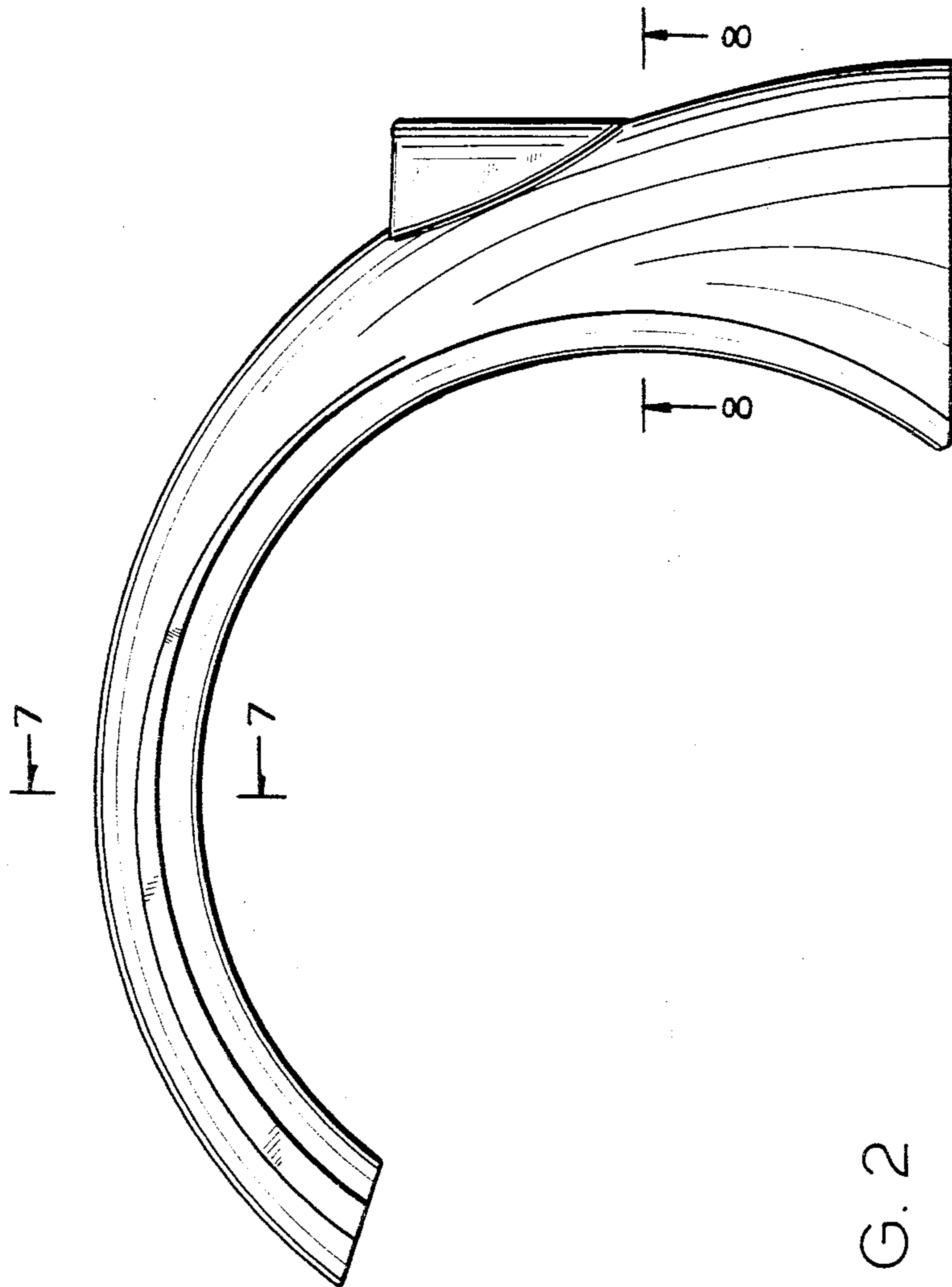

FIG. 2

FIG.3

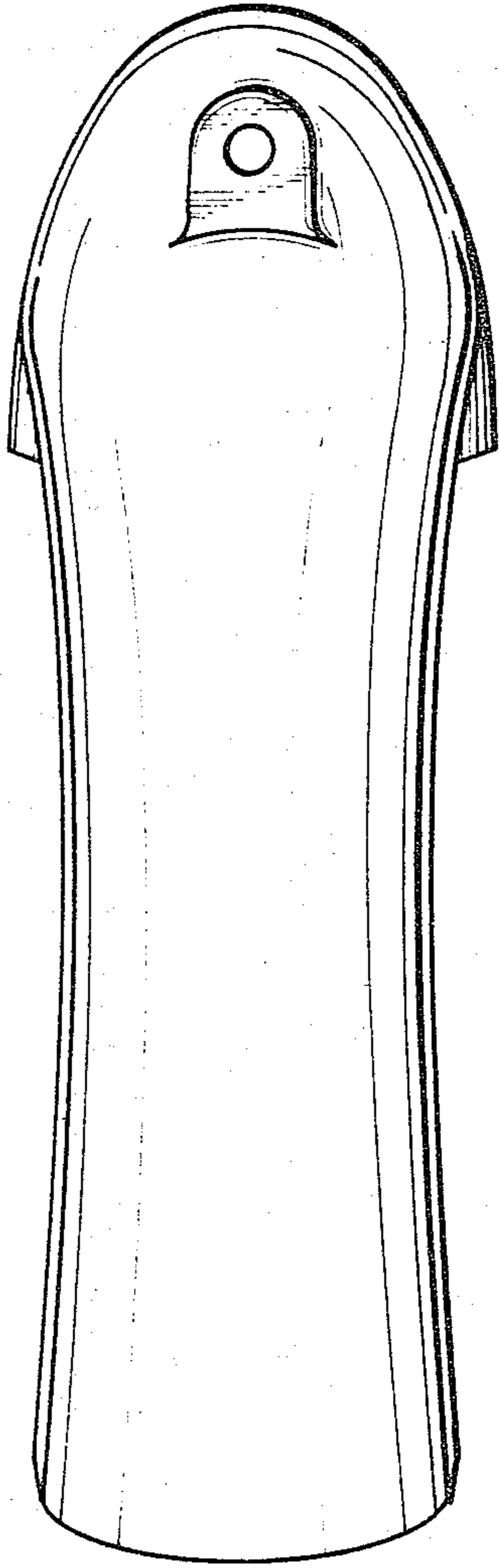

FIG.4

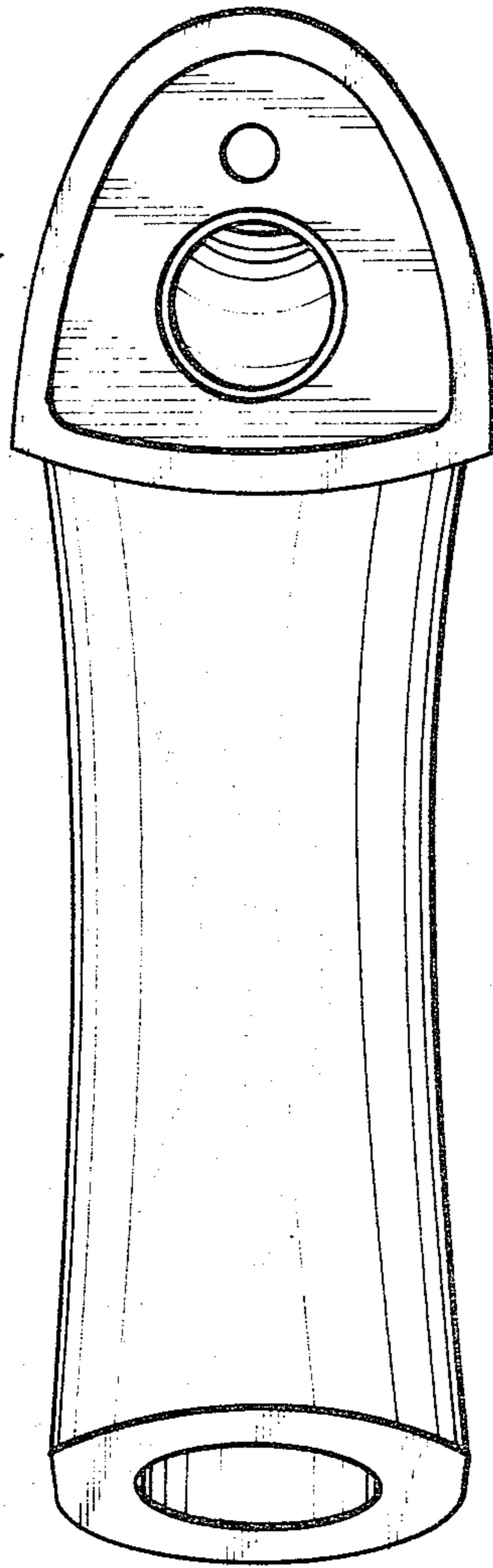

FIG. 5

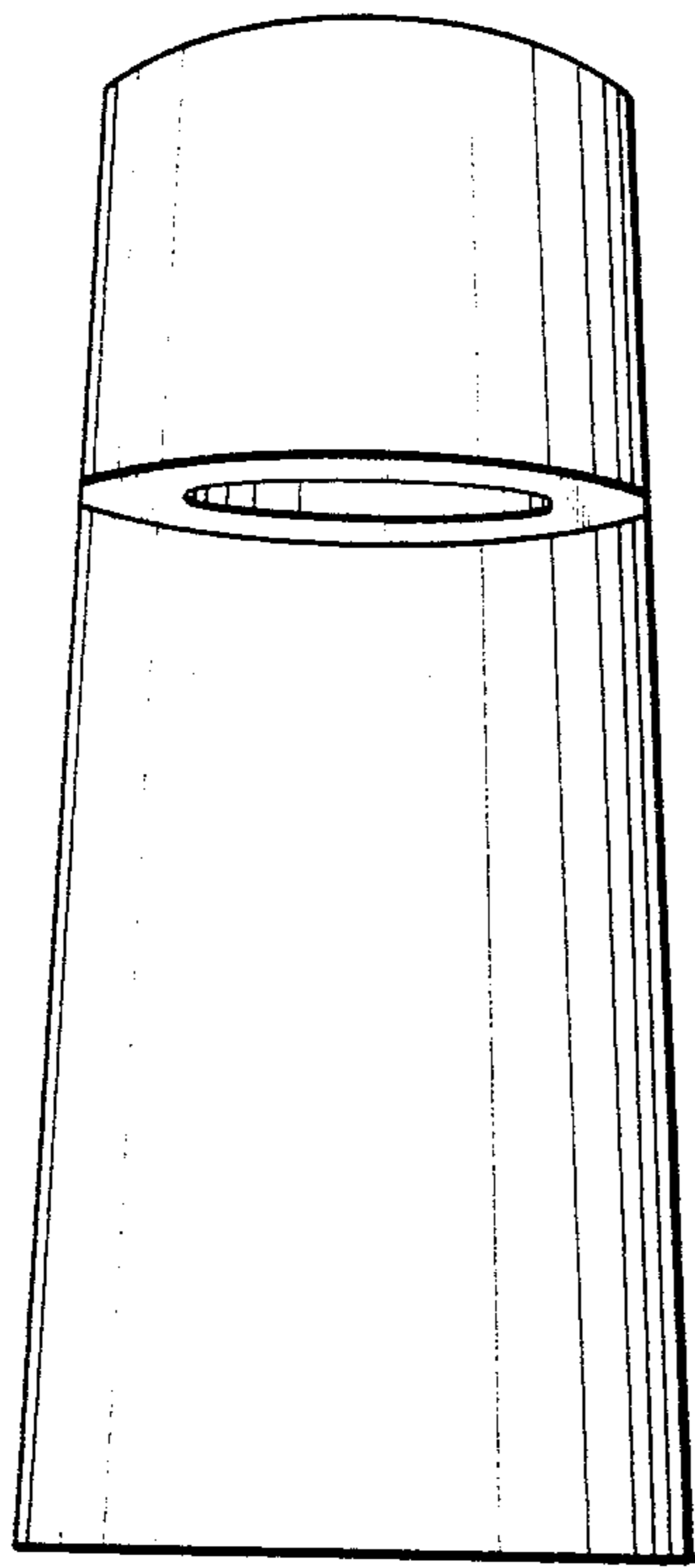

FIG. 6

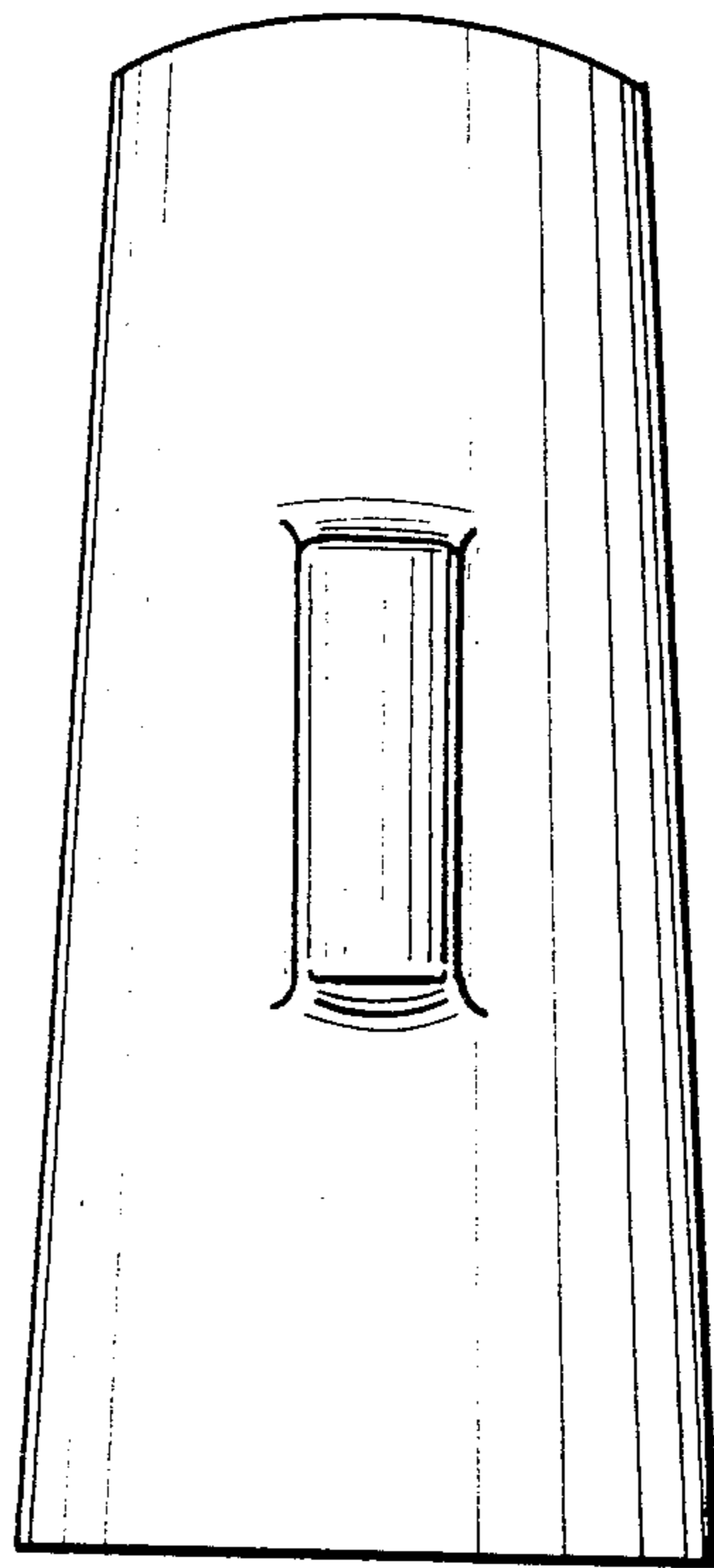

FIG. 7

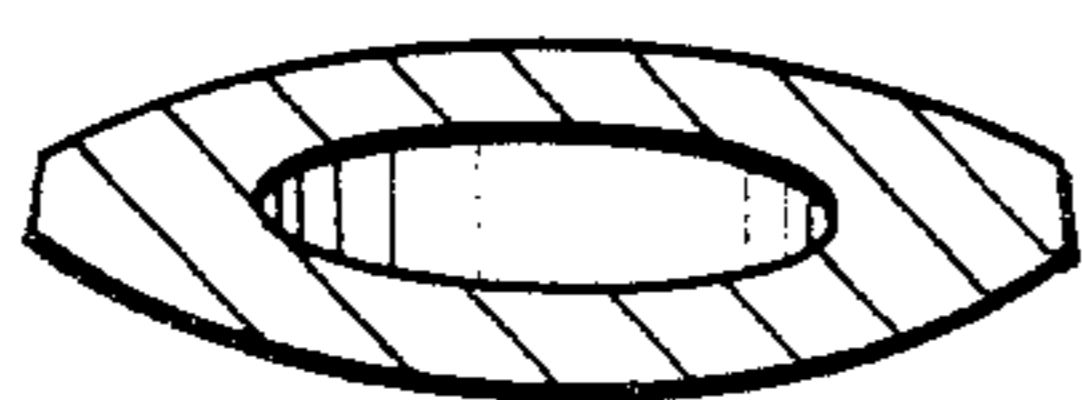

FIG. 8

