

[54] **PRINTER FOR COMPUTER**

[75] Inventor: Haruyuki Enomoto, Tokyo, Japan

[73] Assignee: Sony Corporation, Tokyo, Japan

[**] Term: 14 Years

[21] Appl. No.: 410,992

[22] Filed: Aug. 24, 1982

[30] **Foreign Application Priority Data**

Mar. 2, 1982 [JP] Japan 57-8526

[52] U.S. Cl. D14/111

[58] Field of Search D14/100-117;
D18/13; 400/691, 693; 340/365 R

[56] **References Cited**

U.S. PATENT DOCUMENTS

4,175,878 11/1979 Wing 400/693

OTHER PUBLICATIONS

- Computer Design, 5-1978, p. 105, Qume Printer.
- Datamation, 8-1981, p. 107, Toshiba Word Processor Printer.
- Jade Computer Products Catalog, 1981, p. 17, Epson Printer.
- Jade Computer Products Catalog, 1981, p. 17, Intersell Sellum I Printer.
- Toshiba, Personal Computer, 6 pages, 1981.

- Sharp, Printer, 2 pages, May, 1982.
- Sharp, Printer IO-700, 2 pages, May, 1982.
- Sharp, Computer Display, 4 pages, May, 1982.
- IBM, Typewriter, 5 pages.
- Hitachi, Personal Computer, 2 pages, Jul. 21, 1982.
- Hitachi, Personal Terminal, 4 pages.
- National, Jeditor, 4 pages, Jan. 20, 1982.
- Apple, Apple II, 6 pages.
- Sord, Computer, 2 pages, Jun. 1, 1981.
- Nidecom, Word Processor, 2 pages.
- Nidecom, Word Processor, 4 pages.
- NEC, Personal Computer PC-8001, 6 pages.

Primary Examiner—Susan J. Lucas
Attorney, Agent, or Firm—Lewis H. Eslinger; Alvin Sinderbrand

[57] **CLAIM**

The ornamental design for a printer for computer, as shown and described.

DESCRIPTION

FIG. 1 is a top plan view of a printer for computer embodying my new design, FIG. 2 is a front elevational view thereof, FIG. 3 is a right side elevational view thereof, FIG. 4 is a left side elevational view thereof, FIG. 5 is a rear elevational view thereof, FIG. 6 is a bottom plan view thereof, and FIG. 7 is a front perspective view thereof on a slightly enlarged scale.

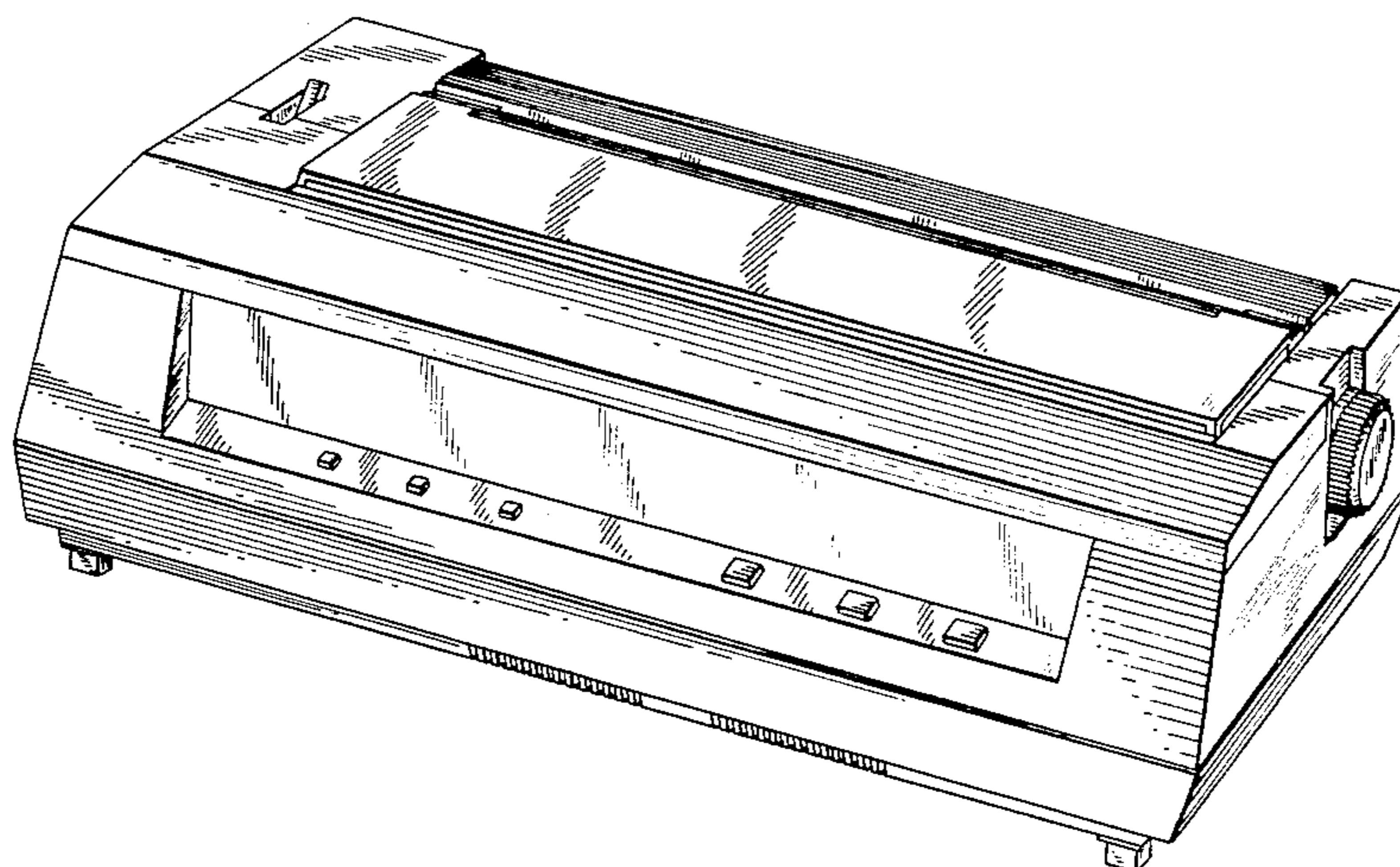

FIG. 1

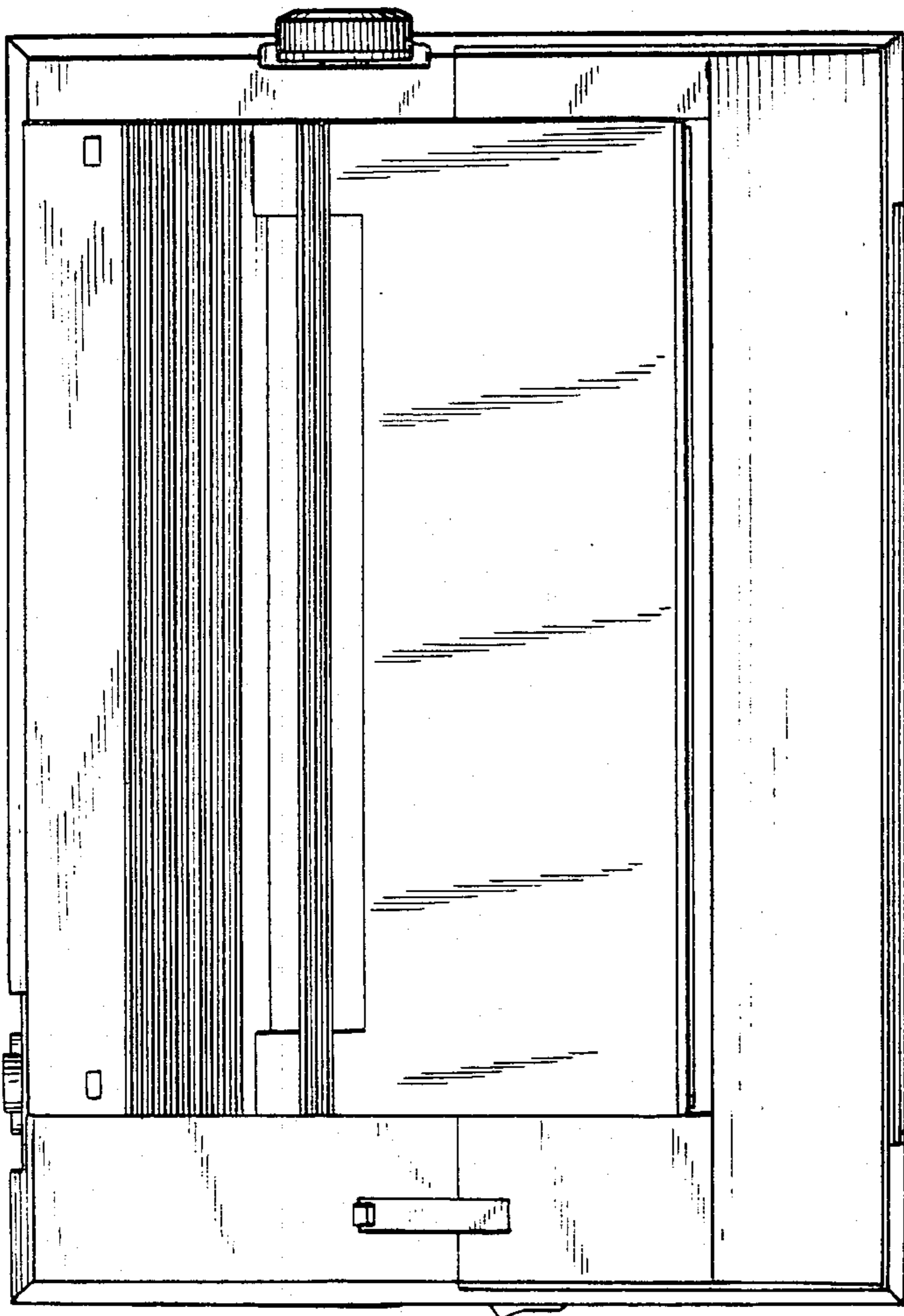

FIG. 3

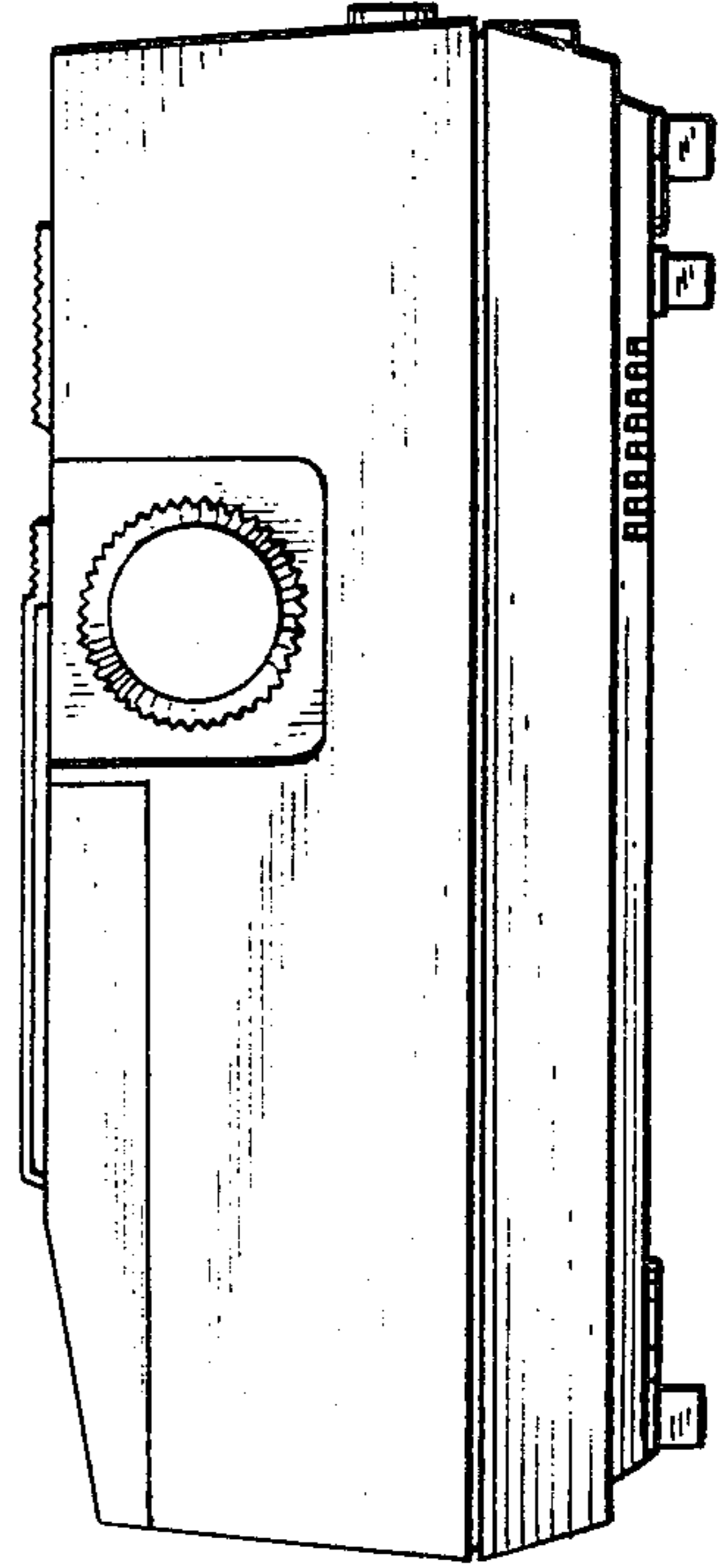

FIG. 2

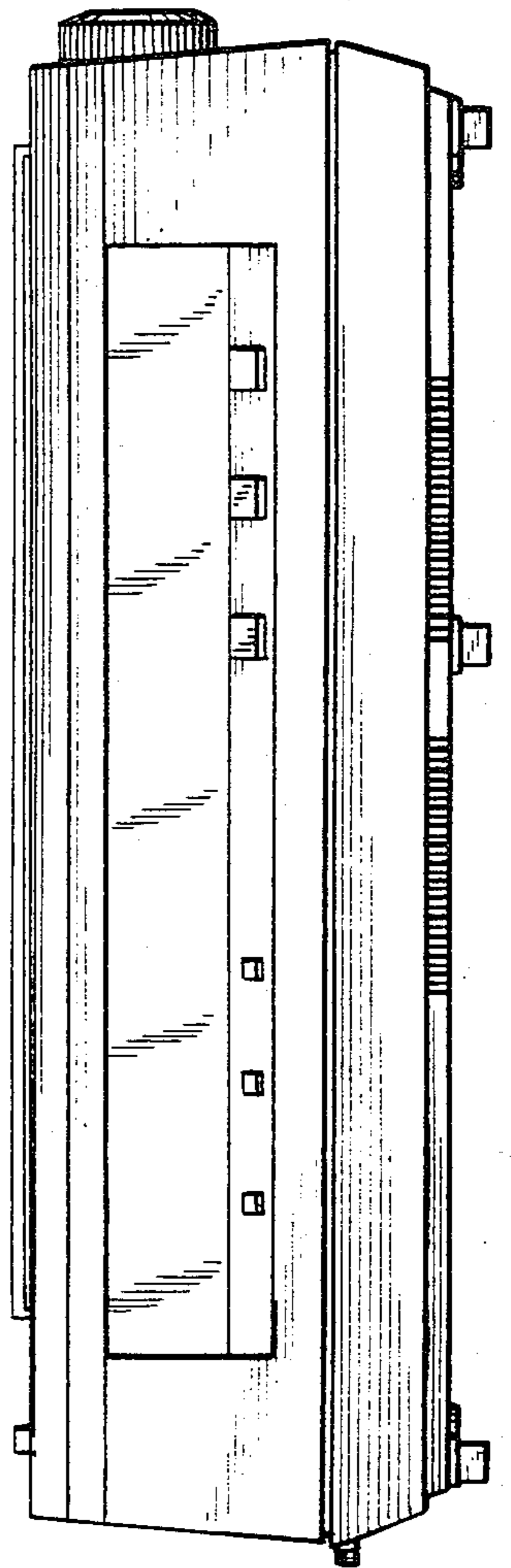

FIG. 5

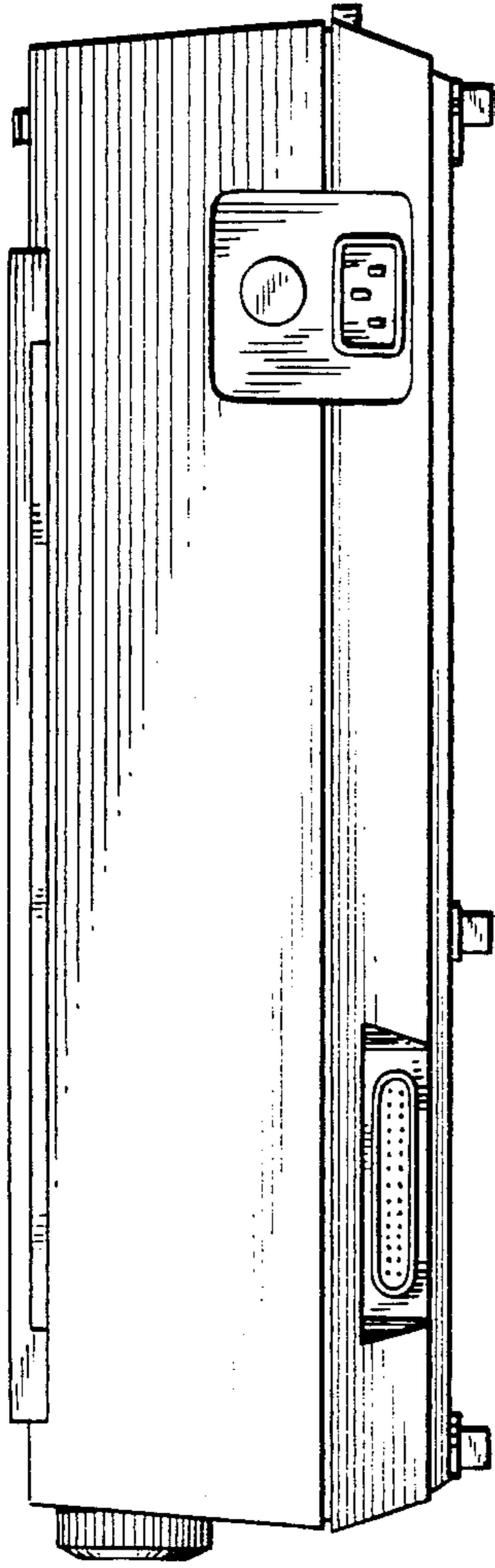

FIG. 4

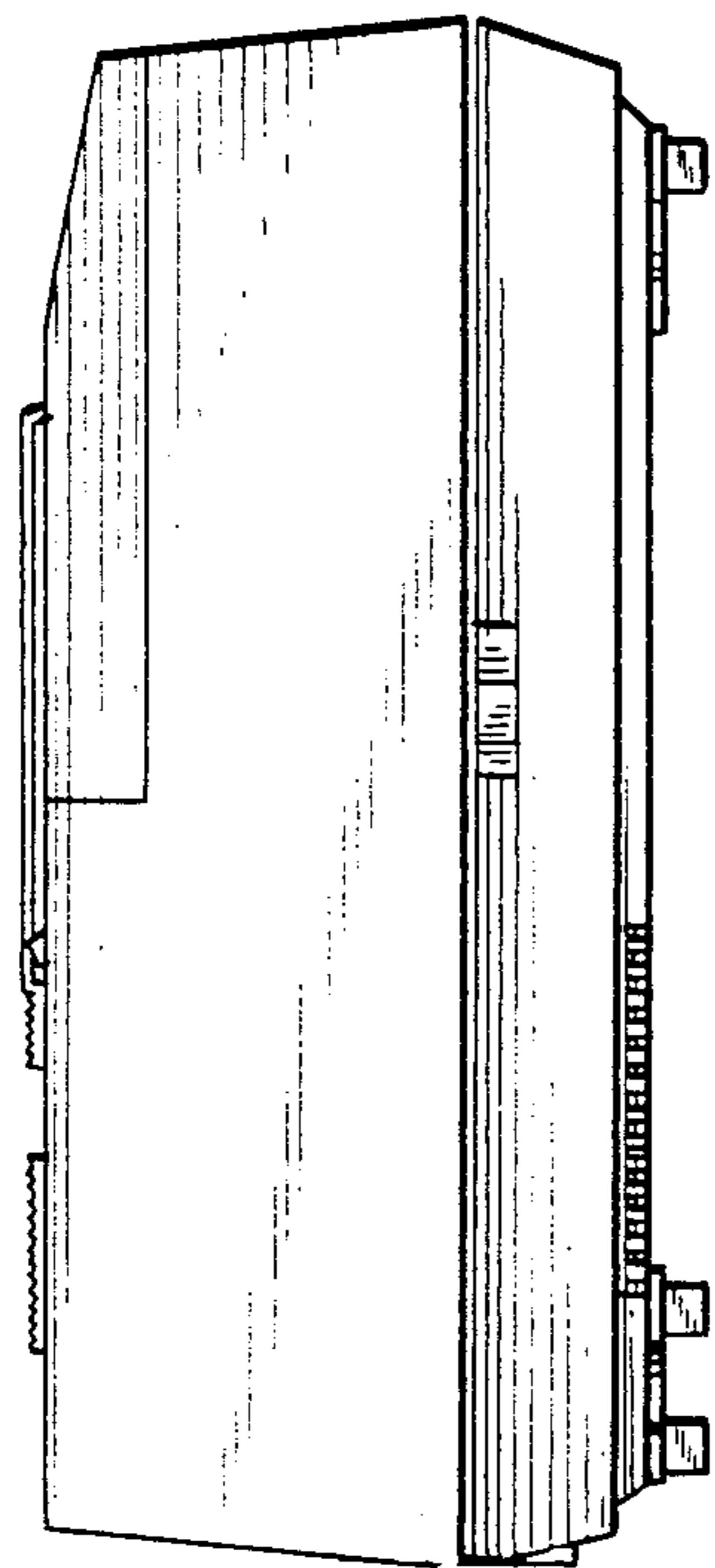

FIG. 6

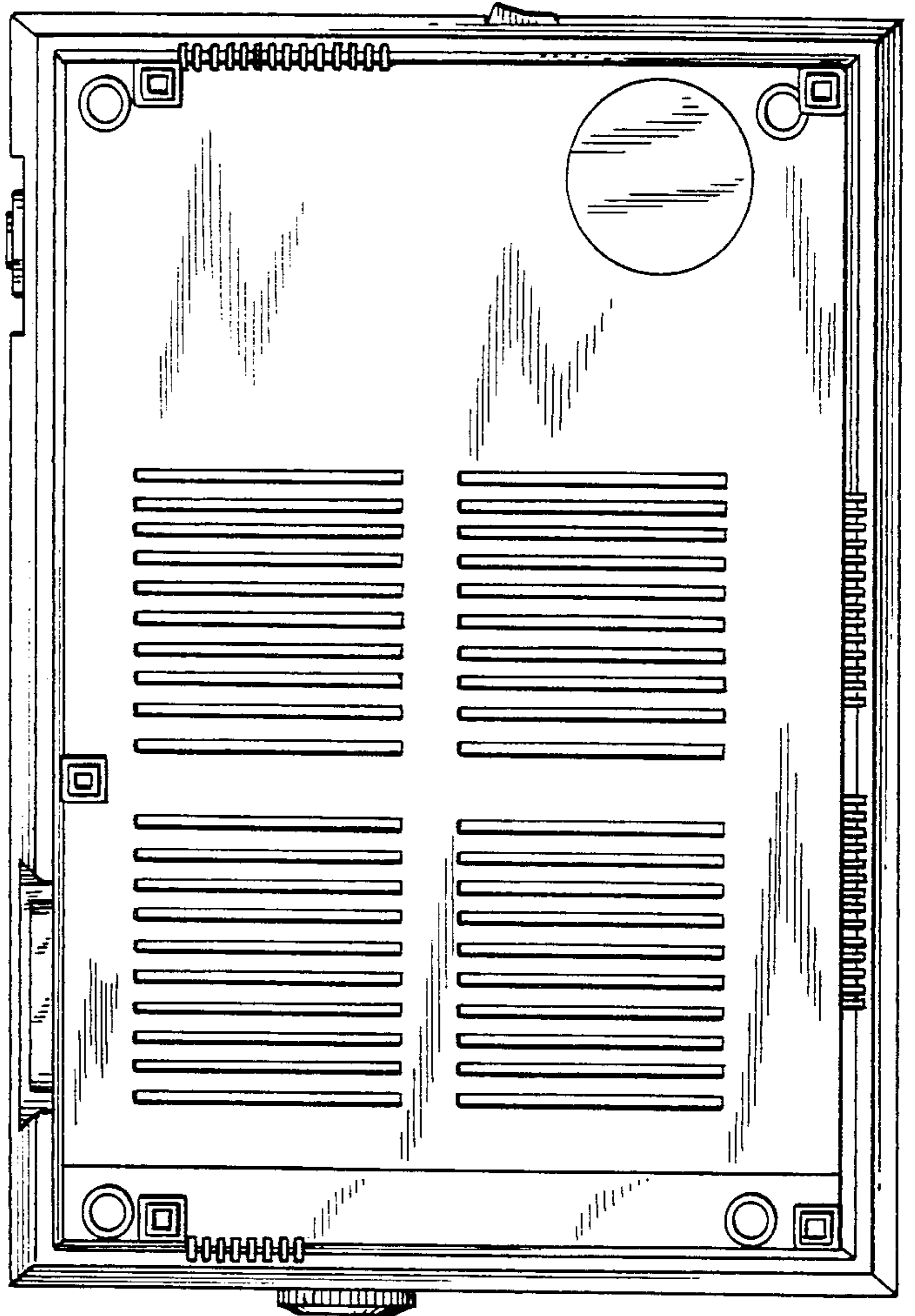

FIG. 7

