

[54] **FIREPLACE INSERT**
 [75] **Inventor: Richard D. Craver, Orrville, Ohio**
 [73] **Assignee: Orrville Products, Inc., Orrville, Ohio**
 [**] **Term: 14 Years**
 [21] **Appl. No.: 603,910**
 [22] **Filed: Apr. 25, 1984**
 [52] **U.S. Cl. D23/94**
 [58] **Field of Search D23/92-97, D23/127, 128; 126/58, 60-66, 120, 121, 123, 126, 138, 139, 141, 190, 200, 202**

2,196,934	4/1940	Morgan	126/120
2,791,213	5/1957	Goulding, Sr.	126/123
4,015,581	4/1977	Martenson	126/121
4,129,113	12/1978	Bergstrom	126/121
4,263,889	4/1981	Martenson	126/123
4,282,855	8/1981	Perry	126/121
4,305,373	12/1981	Martenson	126/121
4,354,480	10/1982	Henderson et al.	126/123
4,375,803	3/1983	Love	126/121
4,441,482	4/1984	Luscombe	126/123

FOREIGN PATENT DOCUMENTS

3140499	4/1983	Fed. Rep. of Germany	126/121
---------	--------	----------------------------	---------

Primary Examiner—Catherine E. Kemper
Attorney, Agent, or Firm—Body, Vickers & Daniels

[56] **References Cited**
U.S. PATENT DOCUMENTS

D. 261,922	11/1981	Mariager et al.	D23/95
D. 262,135	12/1981	Halls	D23/94
D. 262,308	12/1981	Christophel	D23/94
D. 264,496	5/1982	Larsen	D23/93
D. 264,621	5/1982	Becker, Jr.	D23/94
D. 265,237	6/1982	Beck et al.	D23/94
D. 272,176	1/1984	Chastain, Jr.	D23/93
1,309,024	7/1919	Forbes .	
1,336,700	4/1920	Johnston .	
1,546,503	7/1925	Meier .	
2,048,675	7/1936	Baruch et al.	126/132

[57] **CLAIM**
 The ornamental design for a fireplace insert, as shown and described.

DESCRIPTION
 FIG. 1 is a perspective view of a fireplace insert showing my new design;
 FIG. 2 is a plan view thereof;
 FIG. 3 is a front elevational view thereof;
 FIG. 4 is a right elevational view thereof;
 FIG. 5 is a front elevational view of a second embodiment of a fireplace insert; and,
 FIG. 6 is a right elevational view thereof.

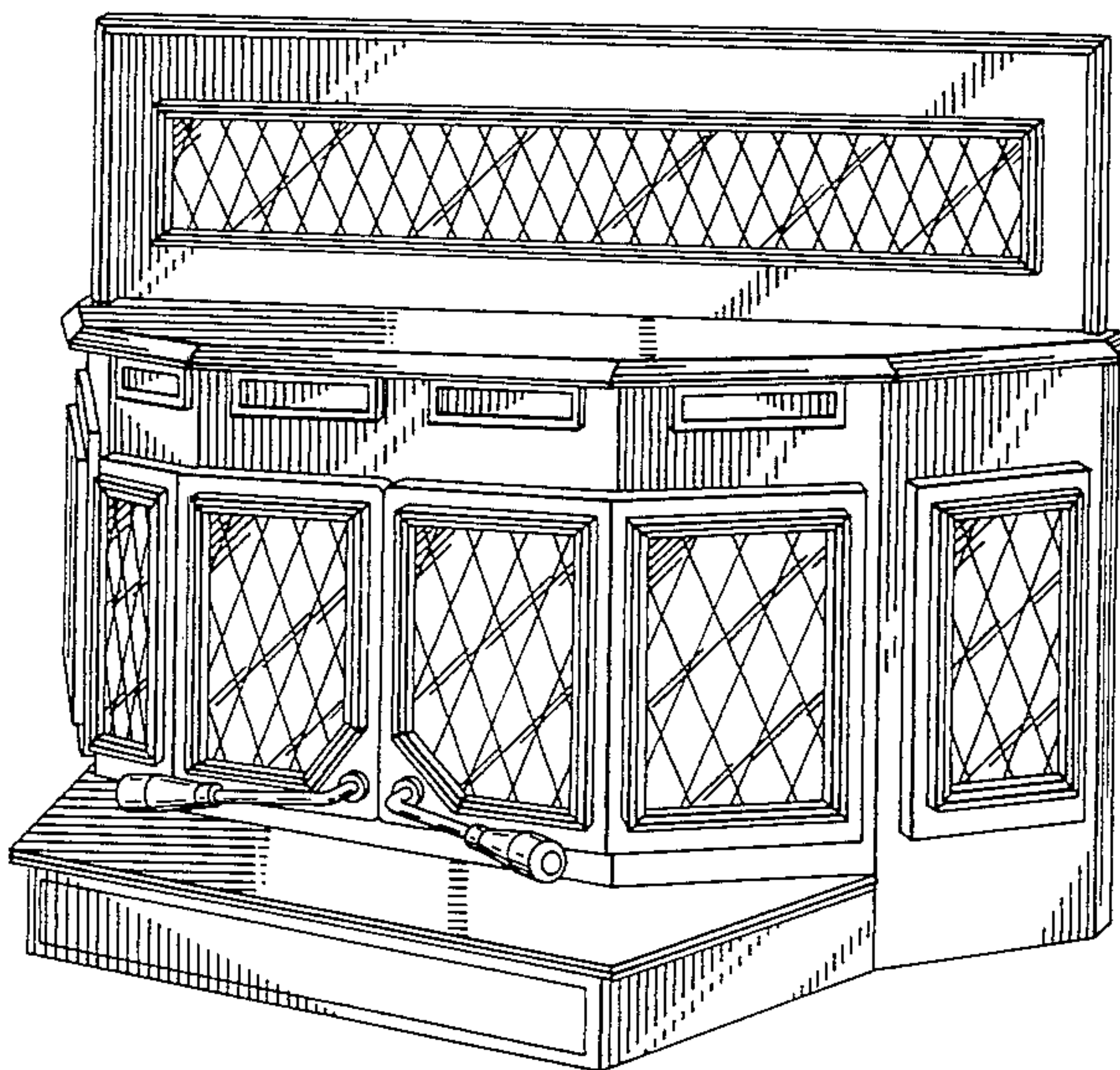

FIG. 1

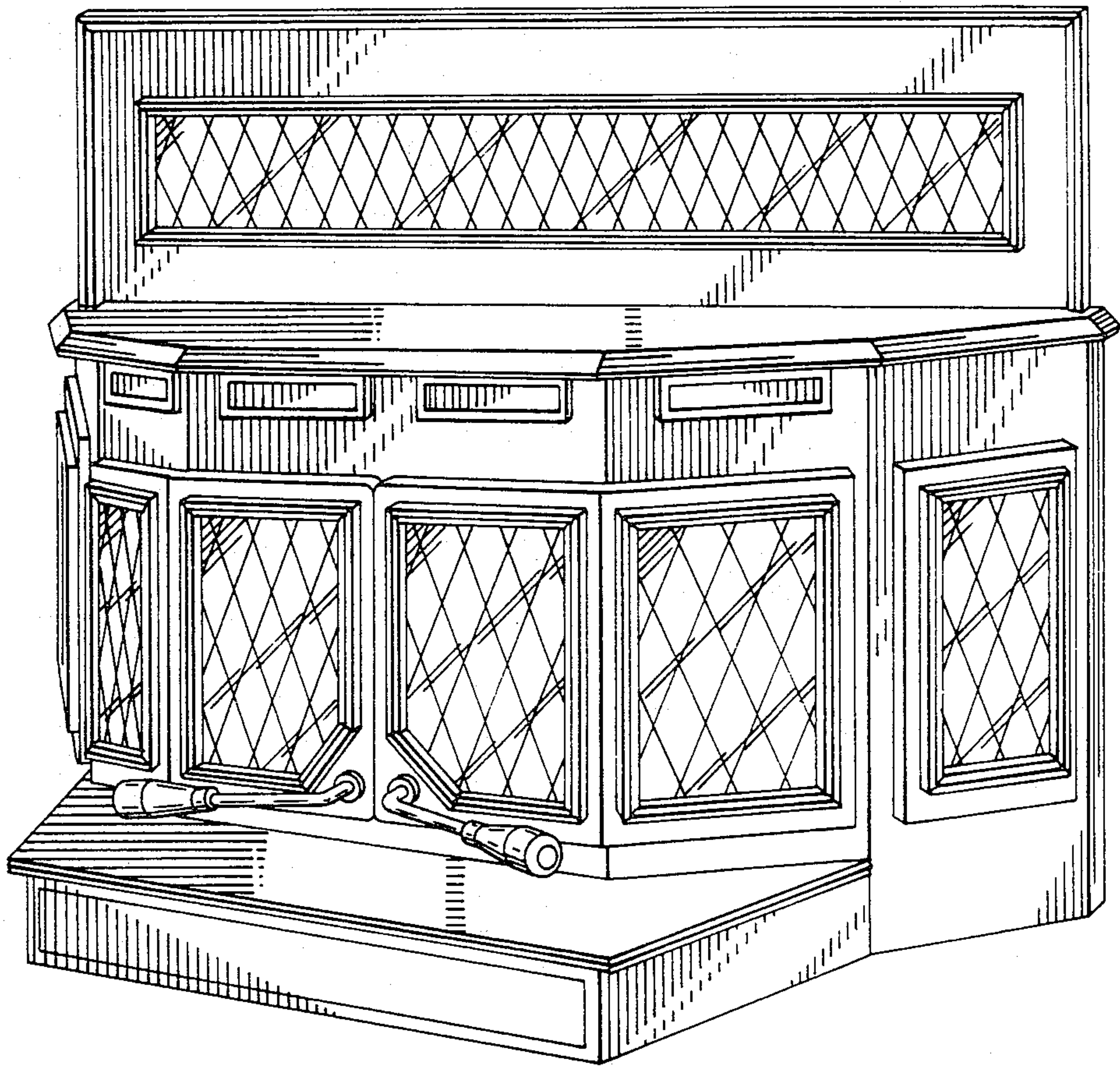
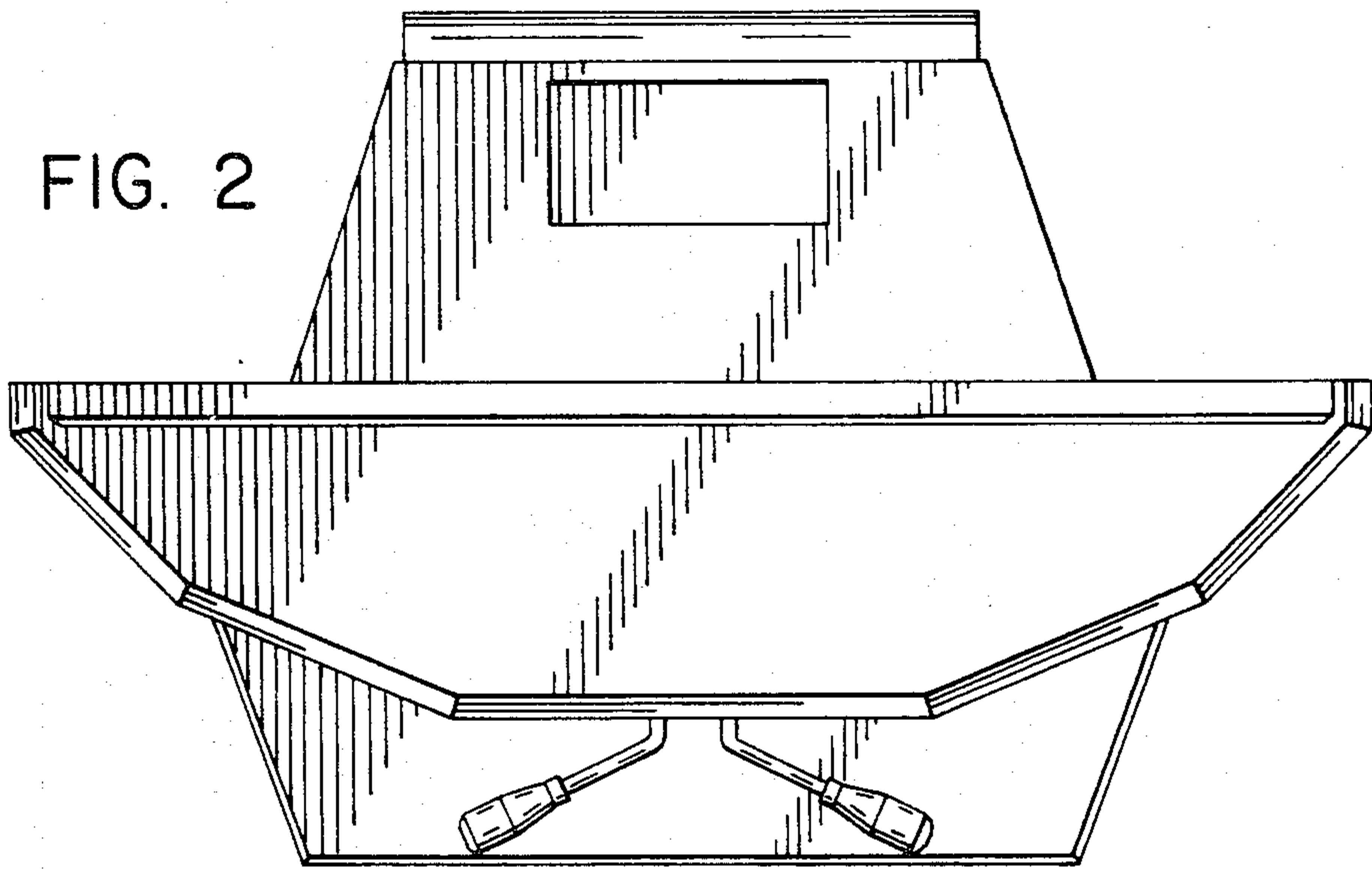

FIG. 2



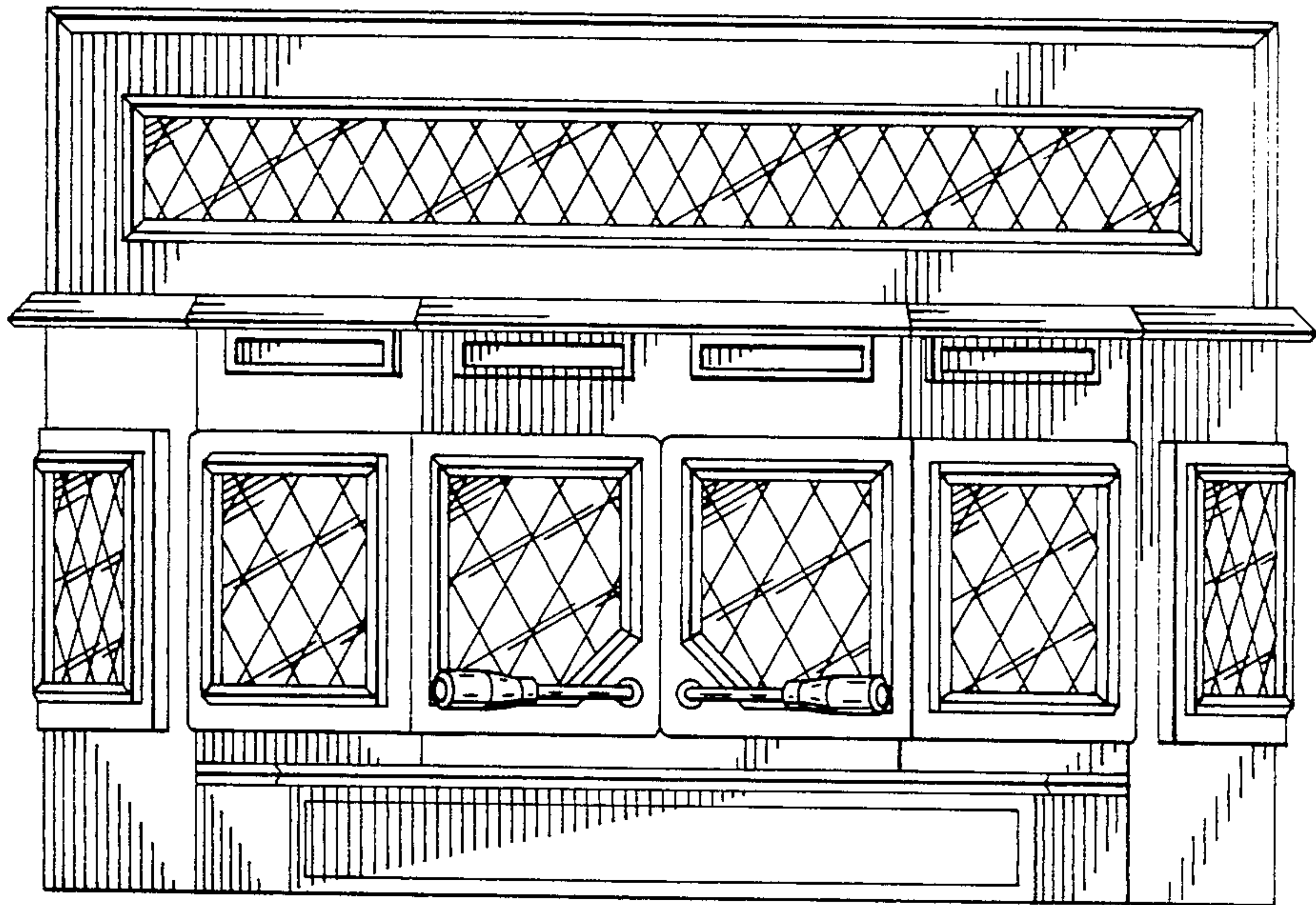

FIG. 3

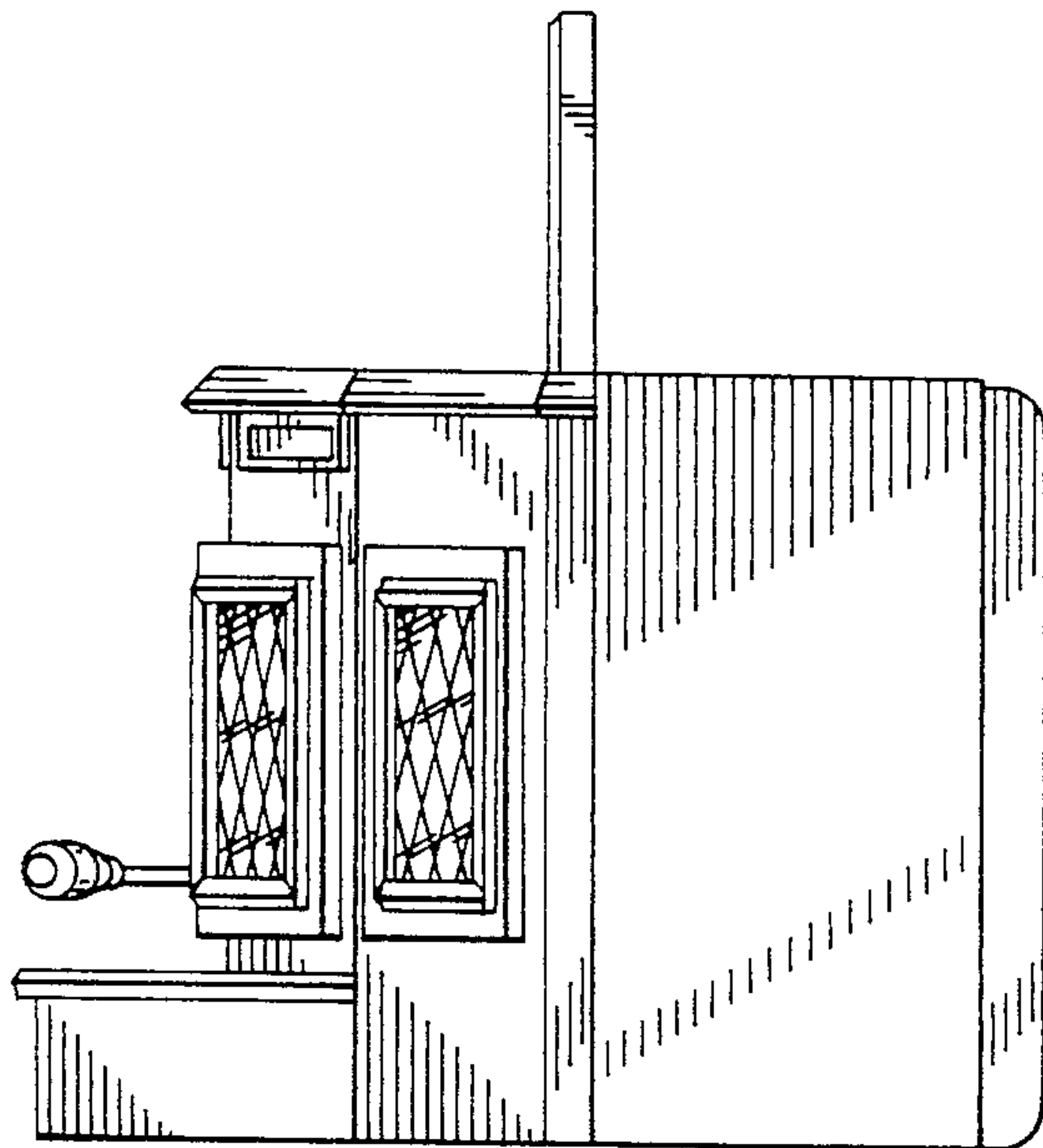

FIG. 4

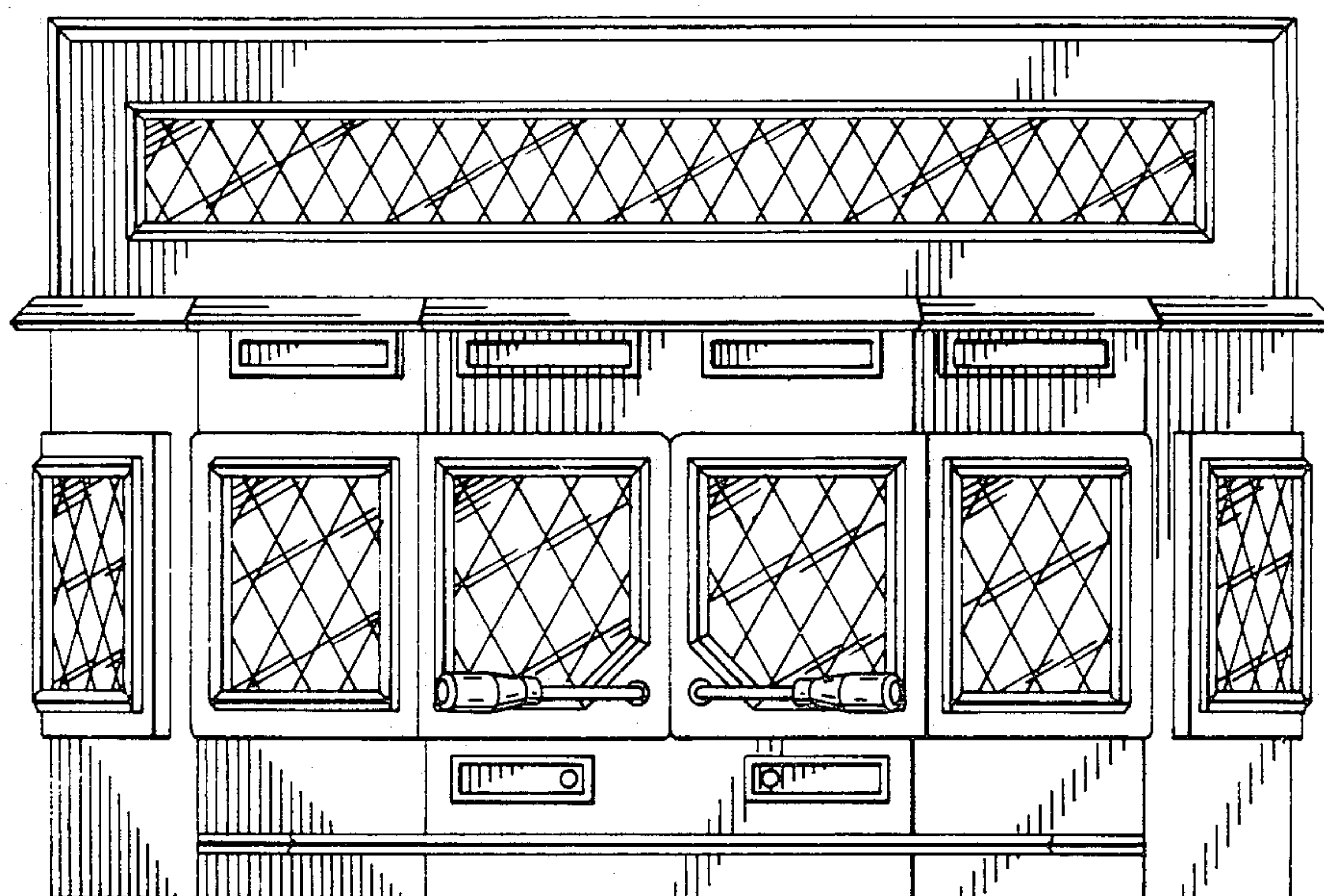

FIG. 5

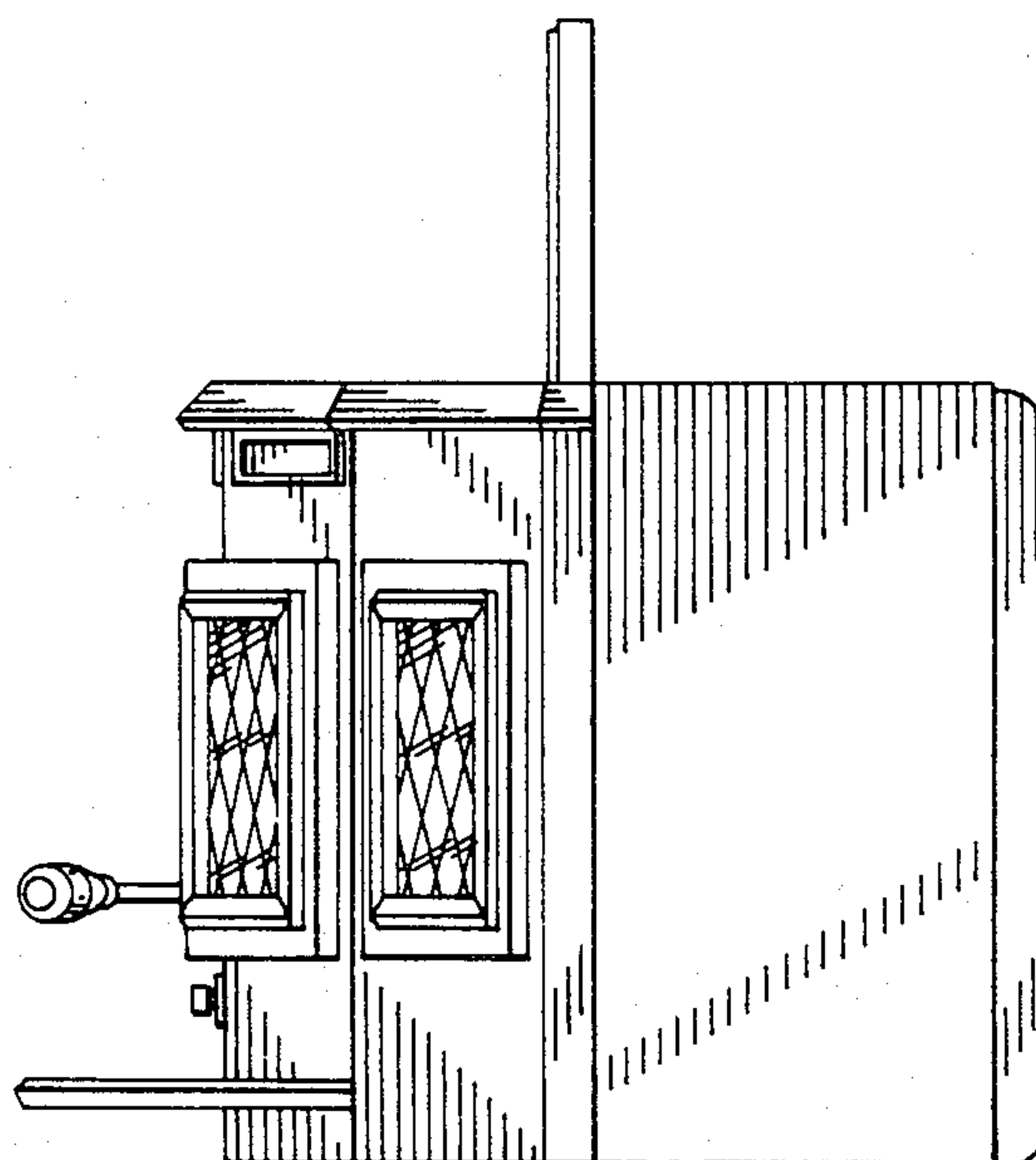

FIG. 6