

[54] **BLACKTOP APPLICATOR BRUSH AND SQUEEGE COMBINATION**

[75] **Inventor: David M. Evans, Cincinnati, Ohio**

[73] **Assignee: Wright-Bernet Incorporated, Hamilton, Ohio**

[**] **Term: 14 Years**

[21] **Appl. No.: 352,192**

[22] **Filed: Feb. 25, 1982**

[52] **U.S. Cl. D4/116; D4/130; D32/41; D32/42; D32/50; D32/51**

[58] **Field of Search D4/1, 3, 4, 6, 10, 11, D4/12; D32/41, 50, 51; 15/105, 106, 111, 114, 117, 121, 15 RR, 160, 245**

[56] **References Cited**

U.S. PATENT DOCUMENTS

D. 186,268 10/1959 Yearley D32/41

D. 270,971 10/1983 Stevens et al. D4/6
4,240,176 12/1980 Farmer 15/117 X

Primary Examiner—Catherine E. Kemper
Attorney, Agent, or Firm—Frost & Jacobs

[57] **CLAIM**

The ornamental design for a blacktop applicator brush and squeegee combination, as shown.

DESCRIPTION

FIG. 1 is a perspective view of a blacktop applicator brush and squeegee combination, showing my new design;

FIG. 2 is a perspective view taken from the opposite side thereof, with the bristle tufts removed for ease of illustration and clarity of disclosure;

FIG. 3 is a front elevational view thereof;

FIG. 4 is a rear elevational view thereof;

FIG. 5 is a side elevational view thereof;

FIG. 6 is a top plan view thereof;

FIG. 7 is a bottom plan view thereof.

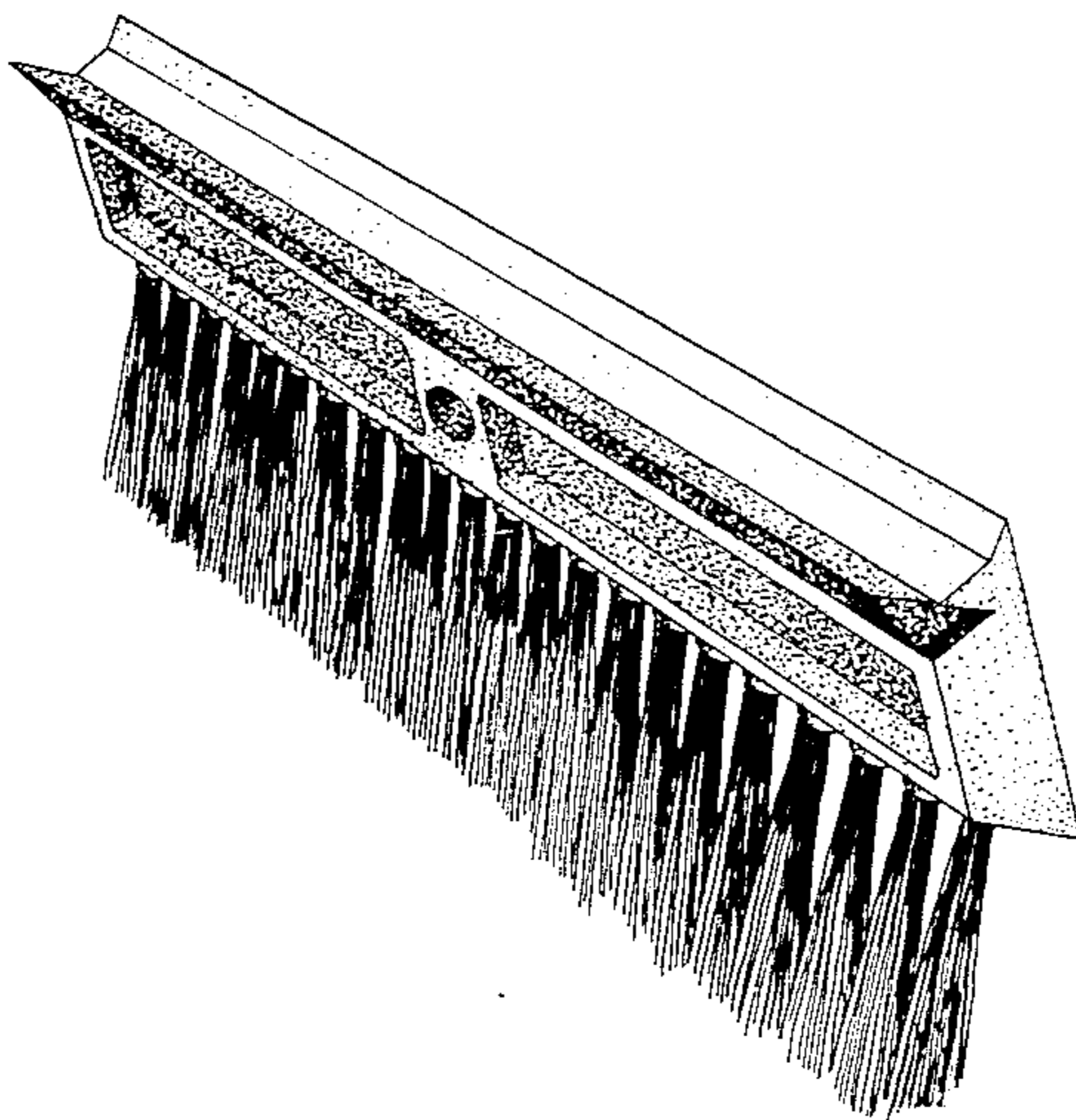

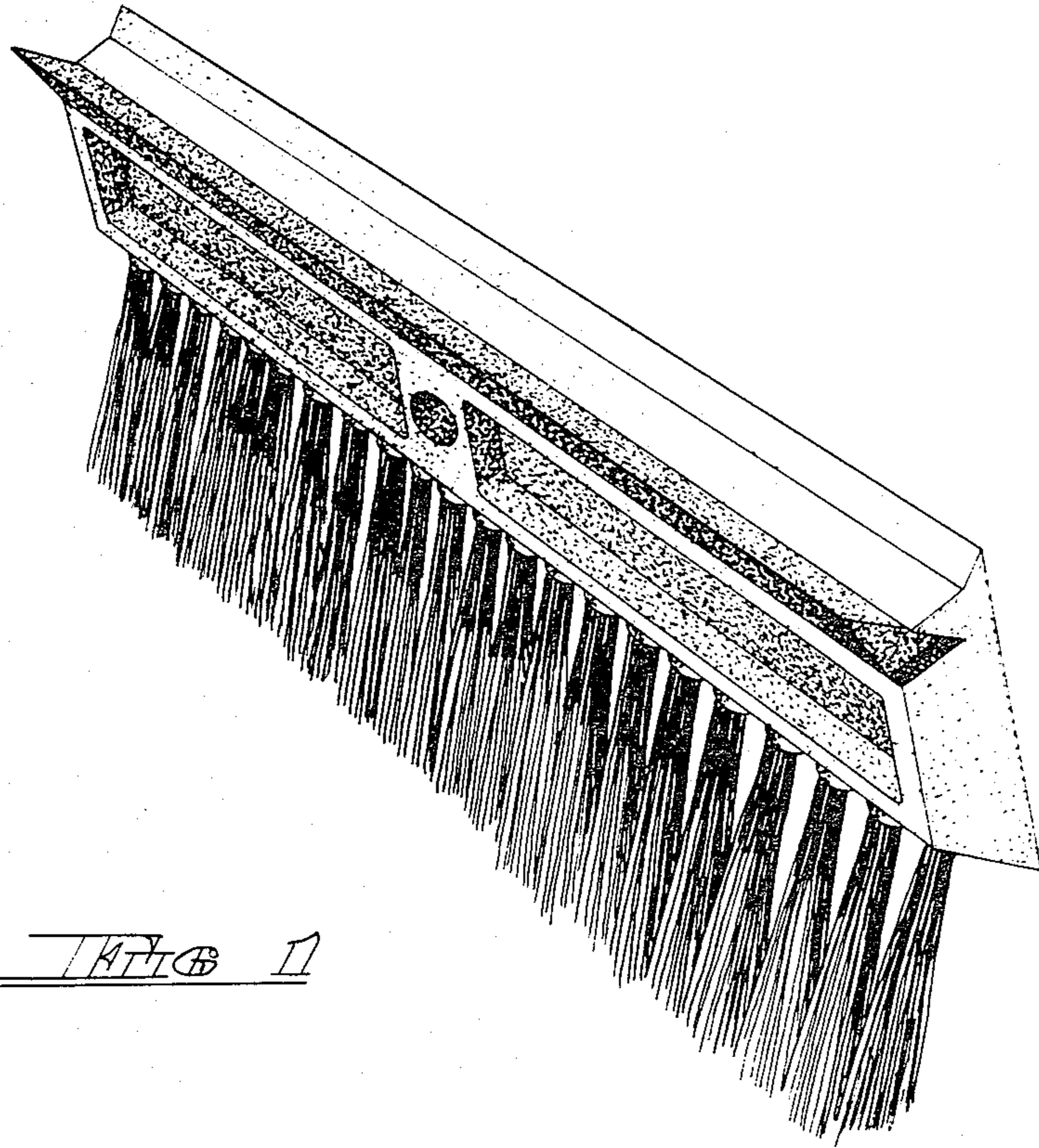

FIG 1

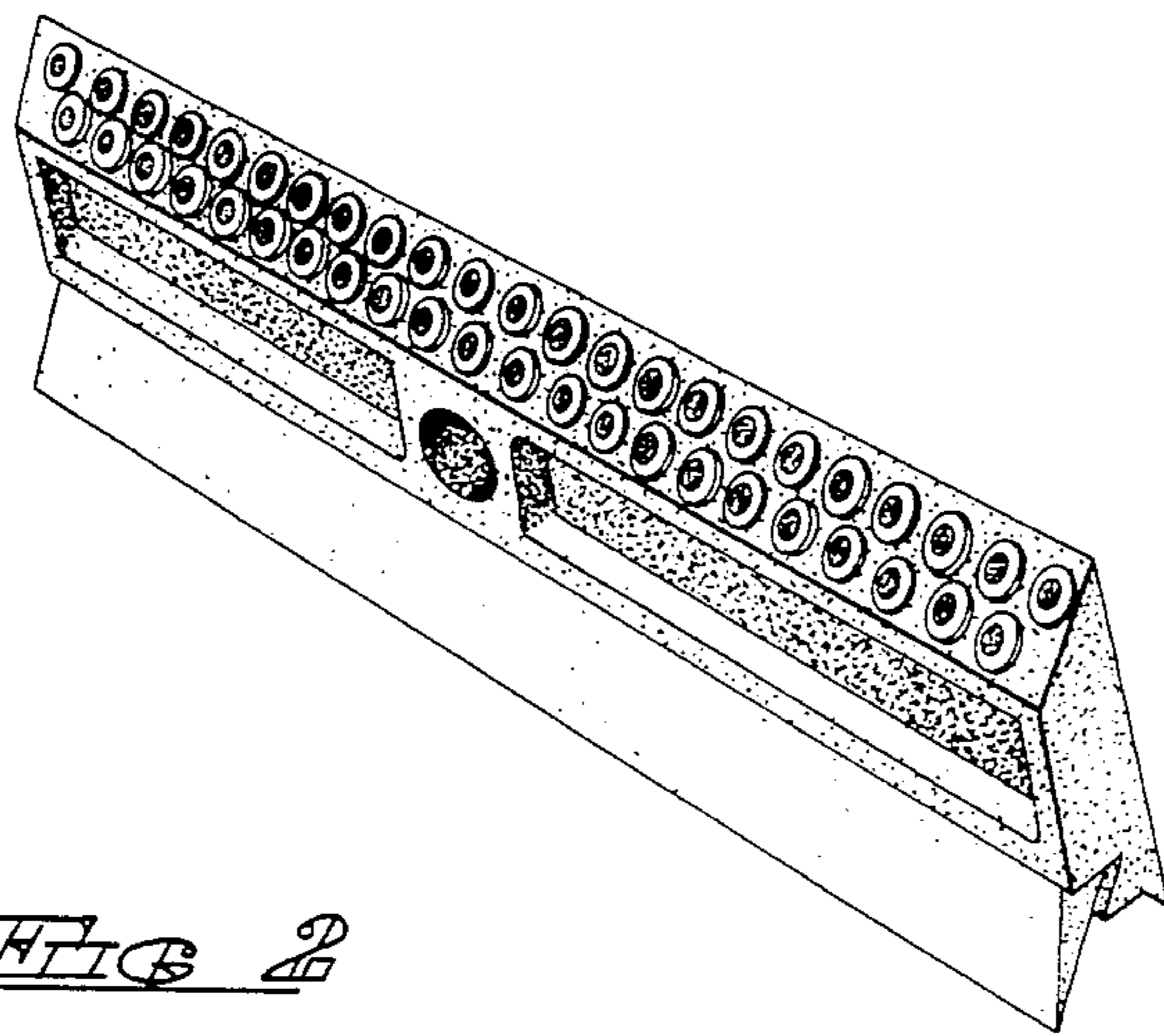

FIG 2

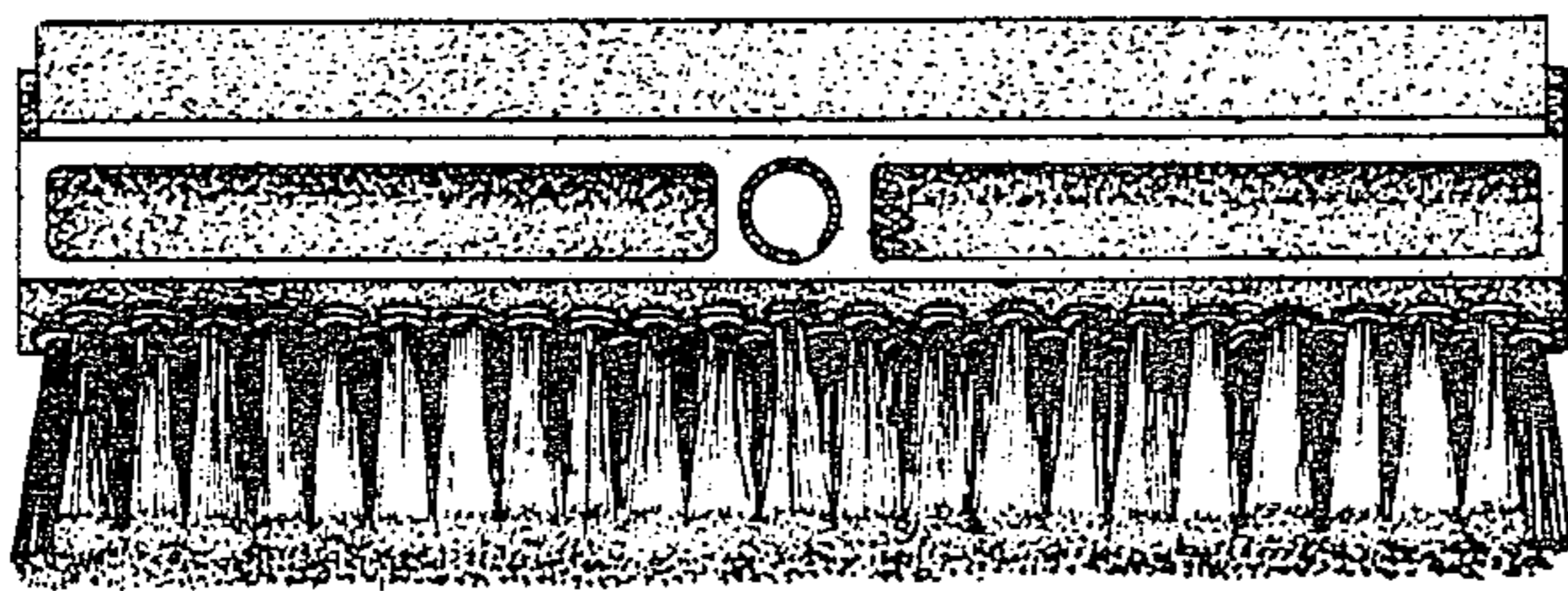

FIG 3

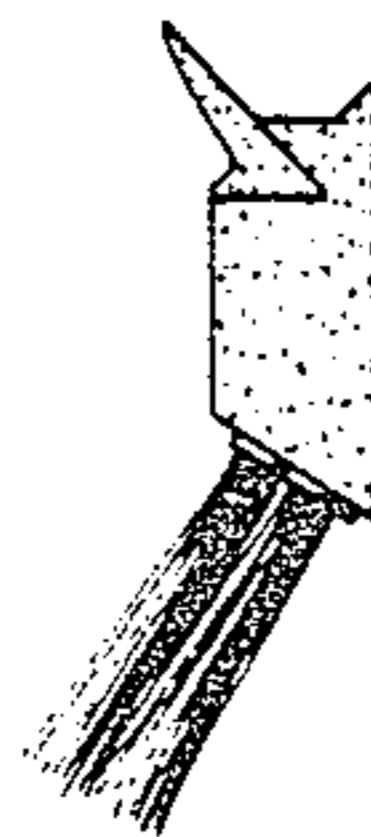

FIG 5

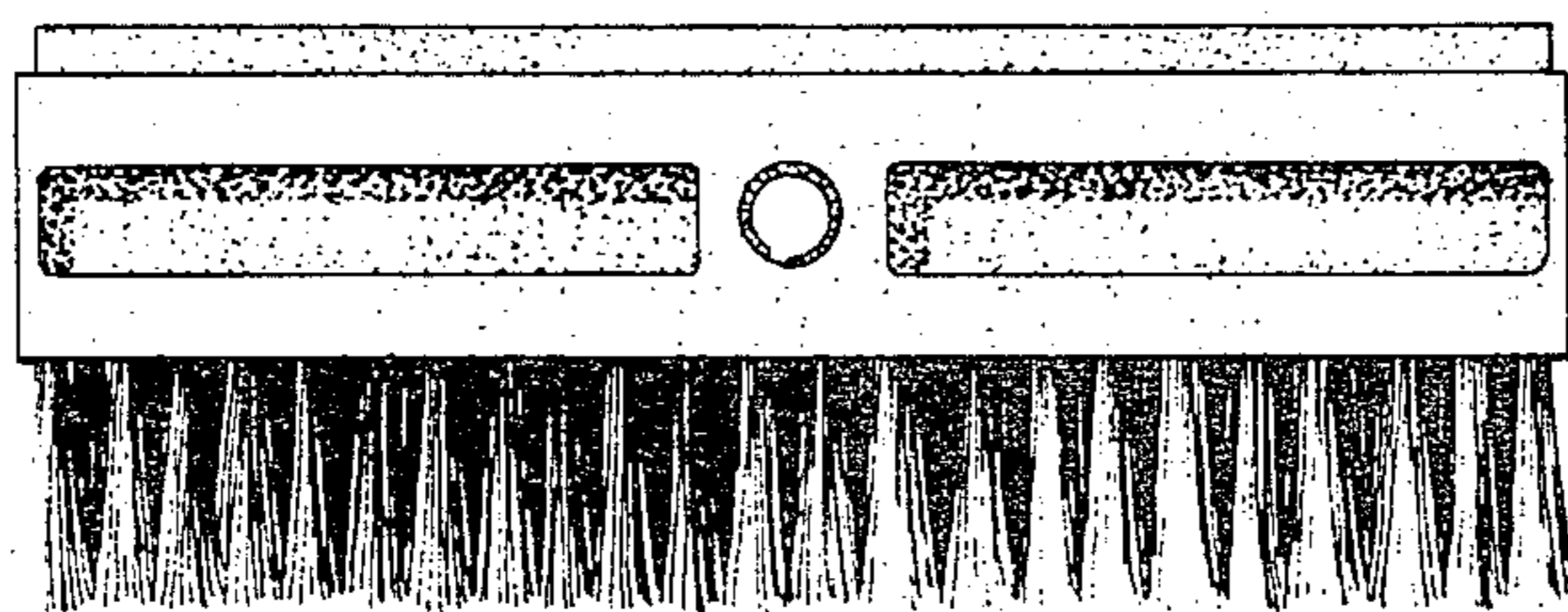

FIG 4

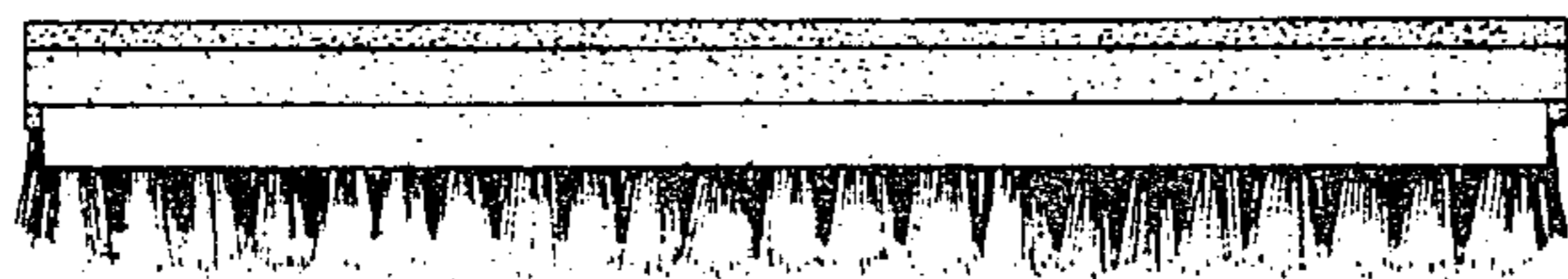

FIG 6

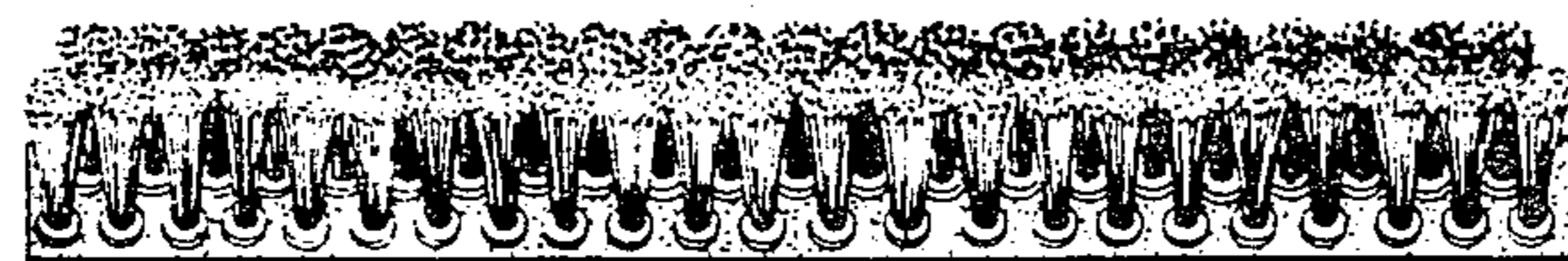

FIG 7