

[54] **PORTABLE MUSICAL SYNTHESIZER**

[76] **Inventor:** Richard J. Garoogian, 3344 E. Dakota Ave., Apt. 224, Fresno, Calif. 93726

[**] **Term:** 14 Years

[21] **Appl. No.:** 412,291

[22] **Filed:** Aug. 27, 1982

[52] **U.S. Cl.** D17/1

[58] **Field of Search** D17/1-7, D17/9; D21/64; 84/177, DIG. 17

[56] **References Cited**

U.S. PATENT DOCUMENTS

- D. 206,683 1/1967 Brodin D17/1
- D. 256,366 8/1980 Dworsky D17/2 X

OTHER PUBLICATIONS

Folk Music Instruments, A. Buchner, ©1971, Artia Prague, Photo #217, Norwegian Zither Langeleik. Markline, Belmont, MA, Spring 1981 Catalog, front cover, Casio Item #CVL1.

Primary Examiner—Jane E. Corrigan
Attorney, Agent, or Firm—Huebner & Worrel

[57] **CLAIM**

The ornamental design for a portable musical synthesizer, as shown and described.

DESCRIPTION

FIG. 1 is a top perspective view of a portable musical synthesizer showing my new design; FIG. 2 is a front elevational view; FIG. 3 is a rear elevational view; FIG. 4 is a top plan view; FIG. 5 is a left side elevational view; FIG. 6 is a right side elevational view; and FIG. 7 is a bottom plan view.

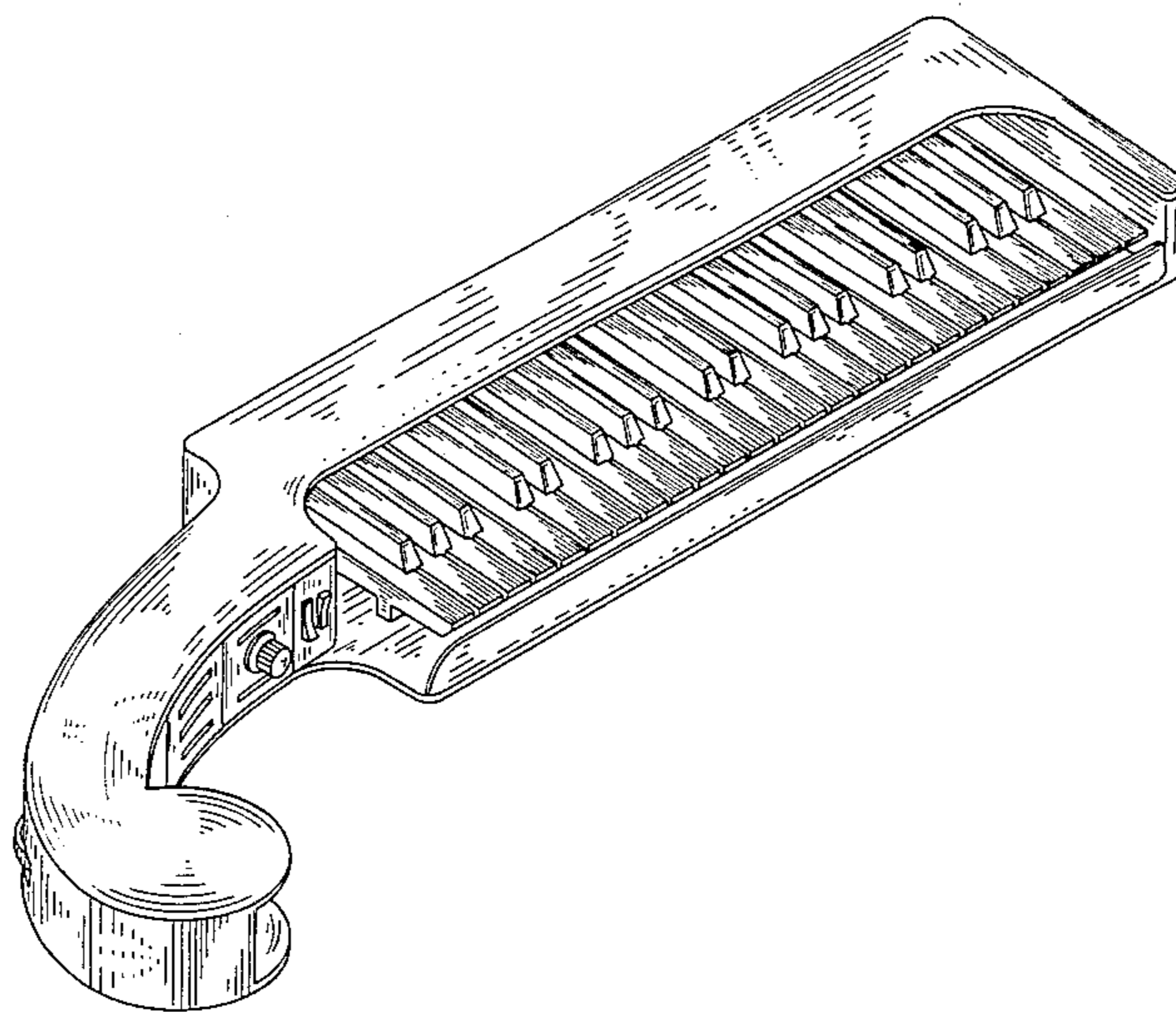

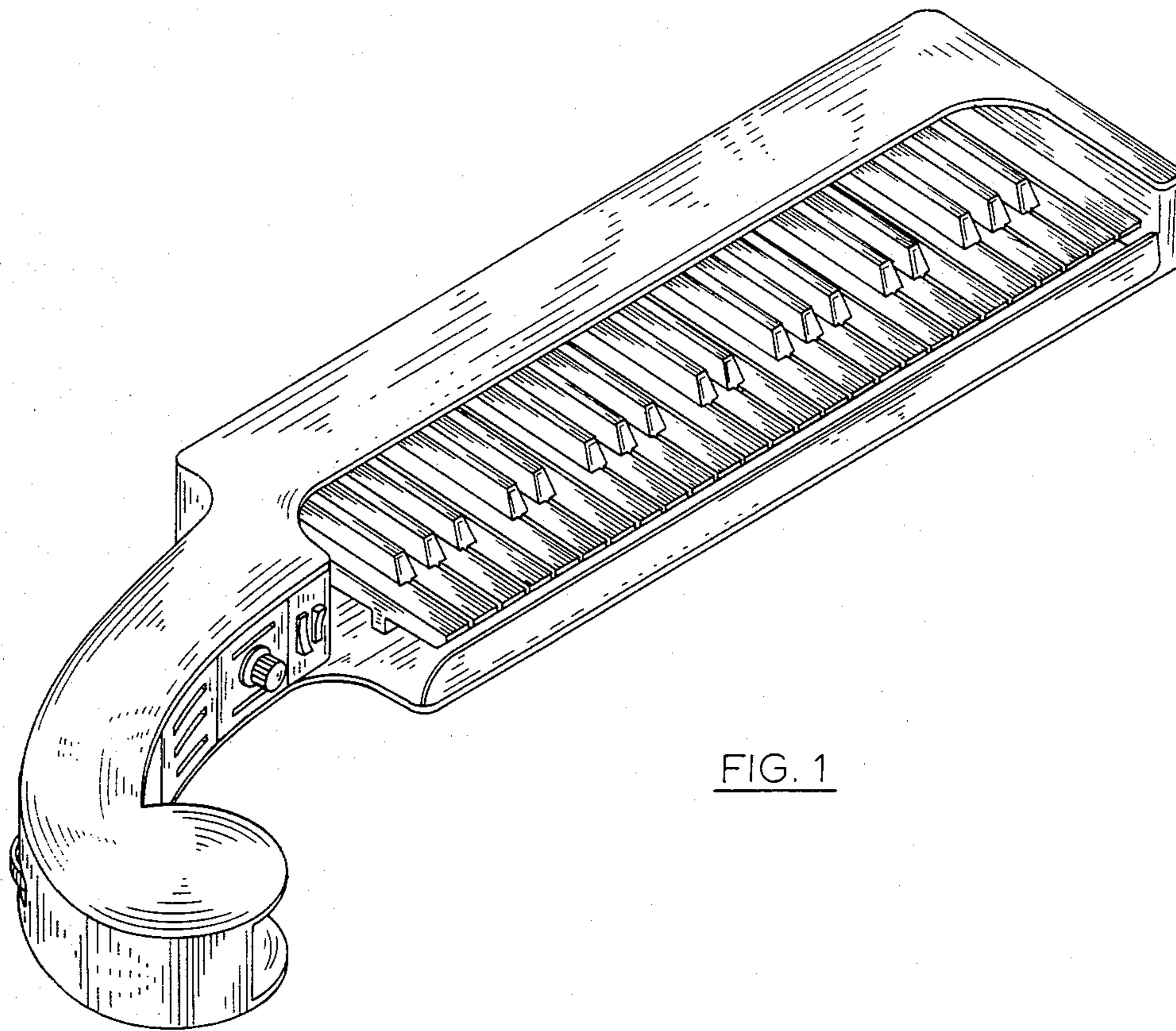

FIG. 1

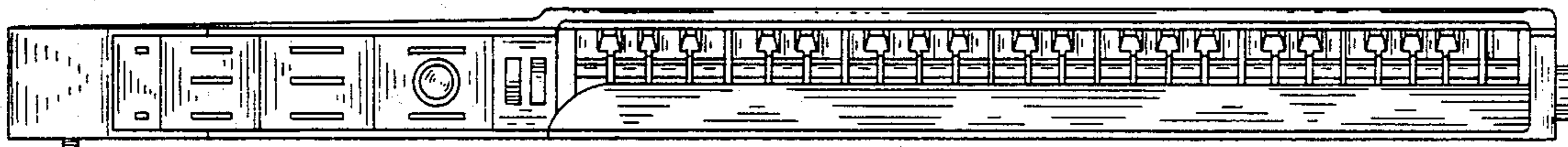

FIG. 2

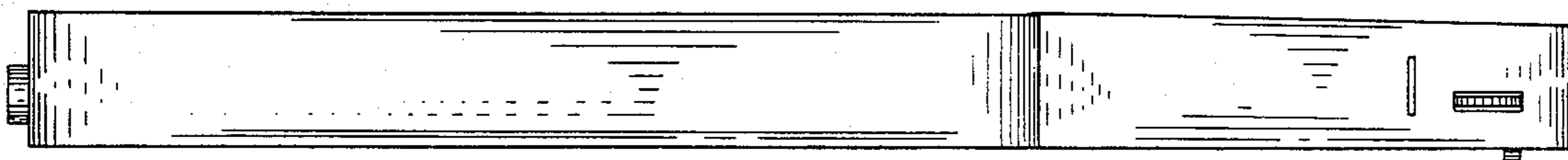

FIG. 3

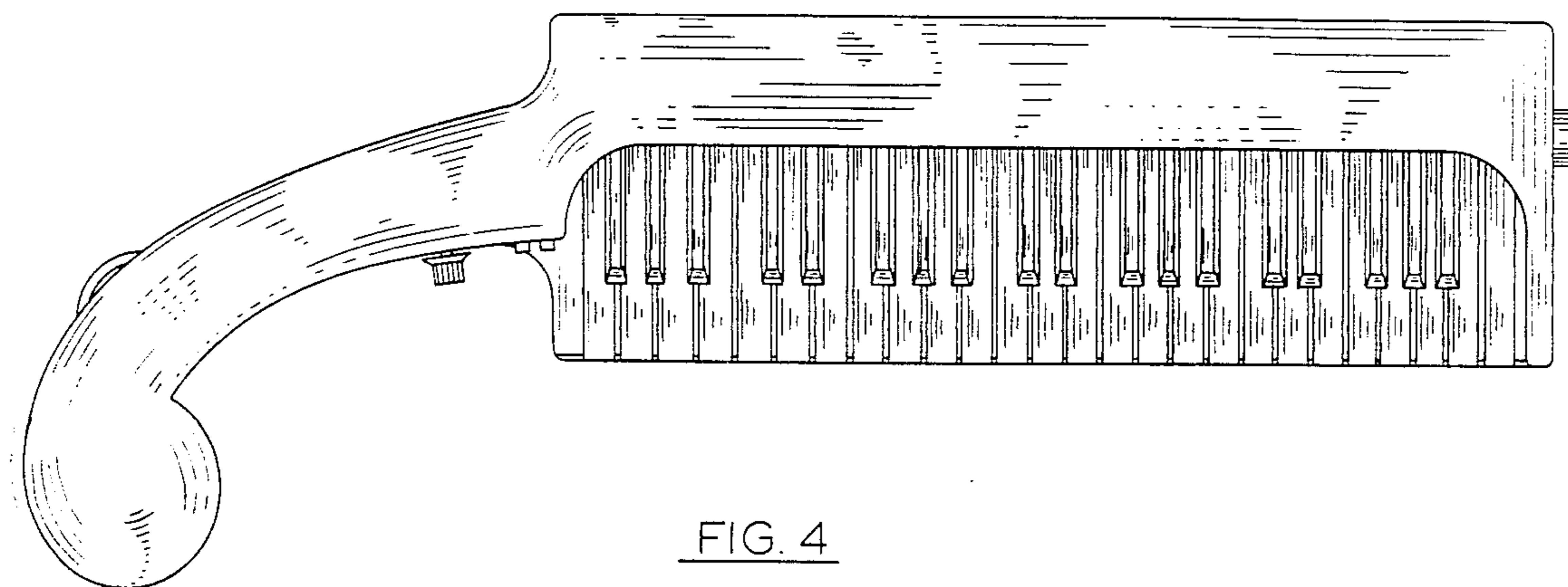

FIG. 4

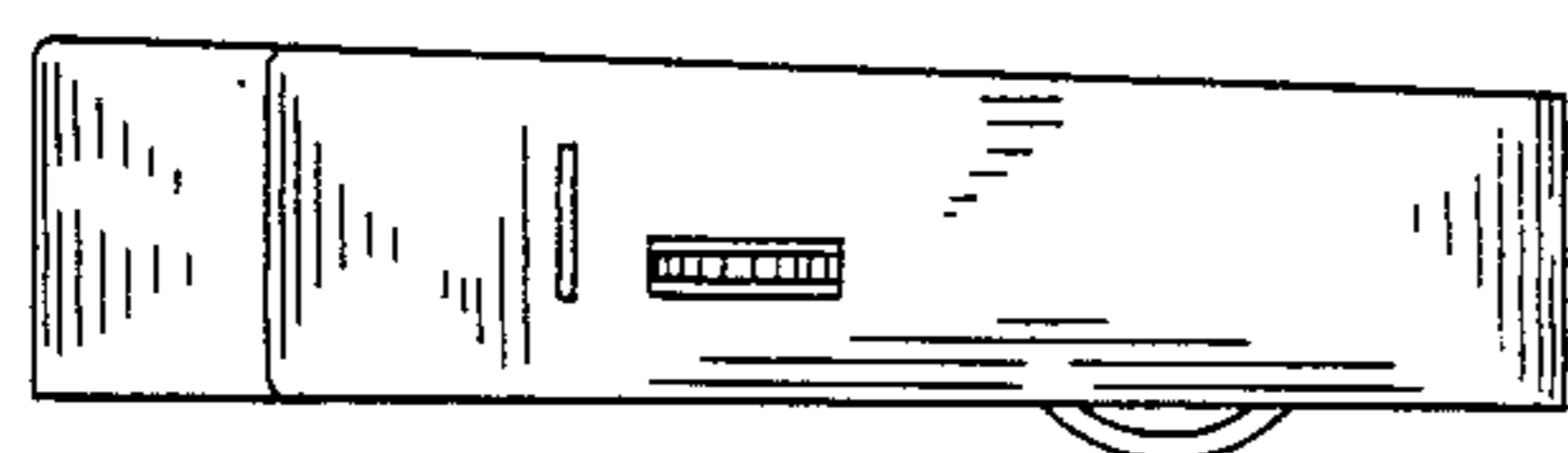

FIG. 6

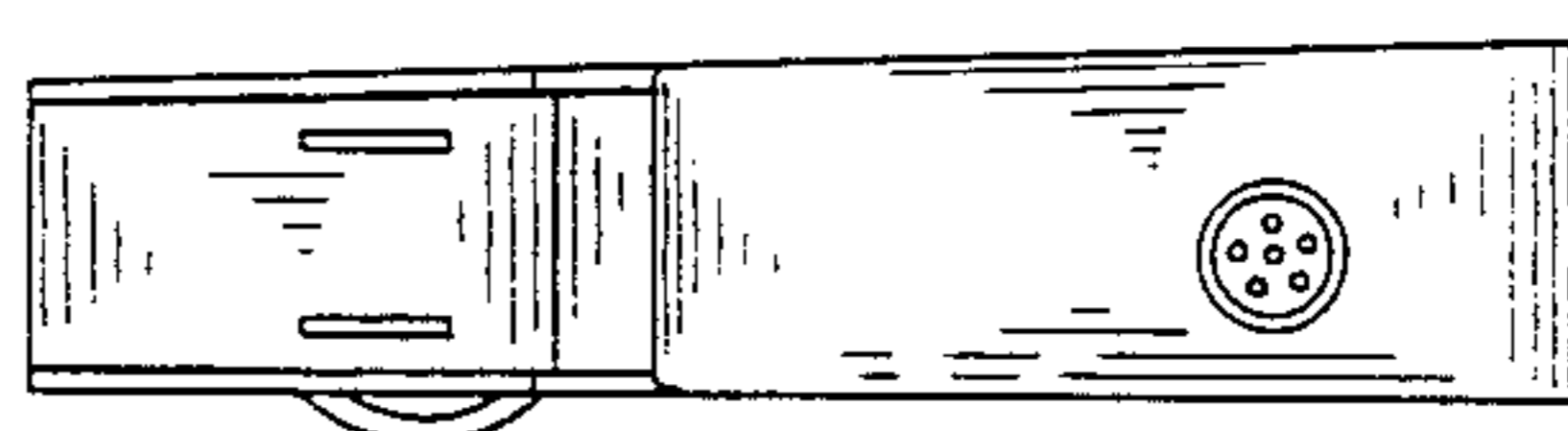

FIG. 5

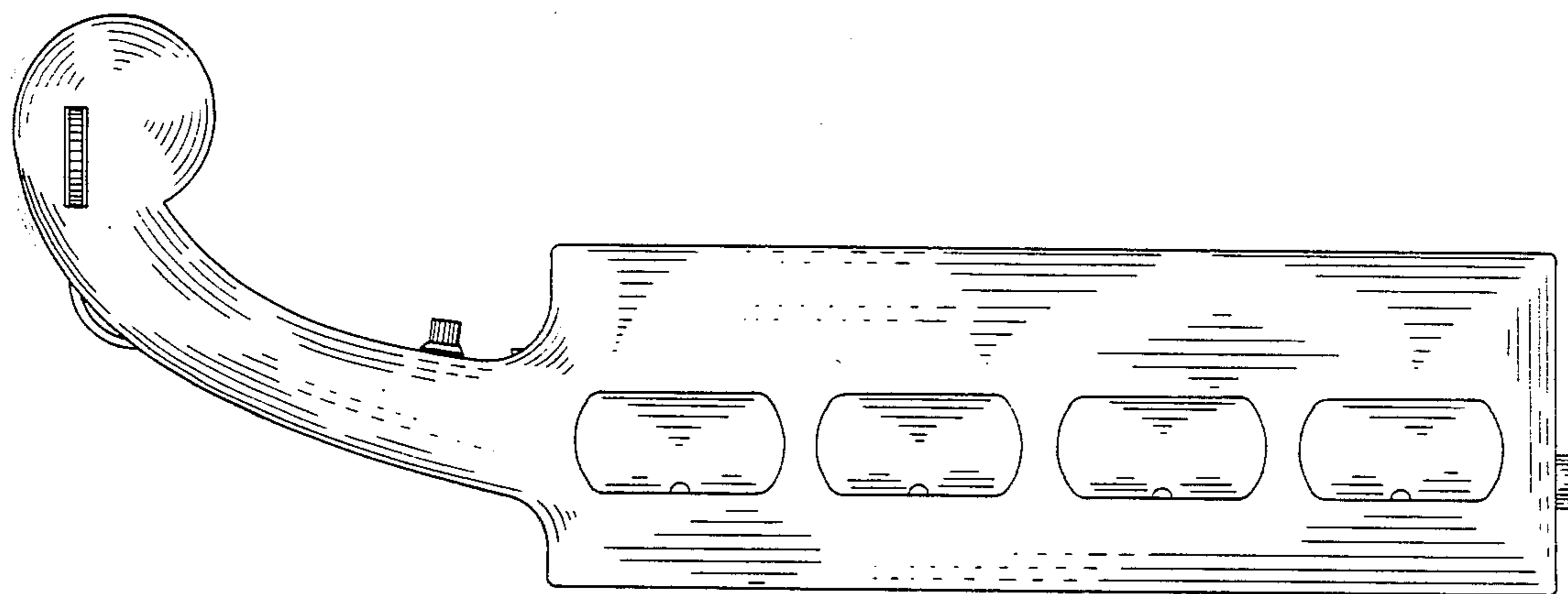

FIG. 7