

[54] COMBINED RECEPTACLE CAP AND CAPSULE PIERCING DEVICE THEREFOR

[75] Inventors: Florence Borkan, Morristown, N.J.; Thomas A. Cafiero, Brooklyn, N.Y.

[73] Assignee: Pharmacaps, Inc., Elizabeth, N.J.

[**] Term: 14 Years

[21] Appl. No.: 415,975

[22] Filed: Sep. 8, 1982

[52] U.S. Cl. D9/437; D9/454

[58] Field of Search D9/434-437, D9/454, 452, 453, 449; 215/228, 250, 257; 220/278; D8/41

[56] References Cited

U.S. PATENT DOCUMENTS

D. 255,427	6/1980	Borkan	9/261
D. 261,619	11/1981	Borkan	D9/437
2,578,979	12/1951	McLean	220/278 X
2,608,972	9/1952	Chrigström	215/228 X
3,810,558	5/1974	Crisp et al.	215/250 X

FOREIGN PATENT DOCUMENTS

810996	4/1969	Canada	220/278
480992	12/1969	Switzerland	215/250

Primary Examiner—Bernard Ansher

Assistant Examiner—Linda M. Titolo

[57] CLAIM

The ornamental design for a combined receptacle cap and capsule piercing device therefor, substantially as shown and described.

DESCRIPTION

FIG. 1 is a side perspective view of a combined receptacle cap and capsule piercing device therefor, showing my new design;

FIG. 2 is an exploded perspective view thereof; shown separately for clarity of illustration;

FIG. 3 is a side elevation of FIG. 1;

FIG. 4 is a top plan view thereof;

FIG. 5 is a bottom plan view thereof;

FIG. 6 is a cross section taken on line 6—6 of FIG. 2;

FIG. 7 is a side perspective view of a modified embodiment of the design illustrated in FIG. 1;

FIG. 8 is an exploded perspective view thereof; shown separately for clarity of illustration;

FIG. 9 is a side perspective view of the capsule piercing member shown separately for clarity of illustration;

FIG. 10 is a side elevation of FIG. 7;

FIG. 11 is a top plan view thereof;

FIG. 12 is a bottom plan view thereof; and

FIG. 13 is a cross section view taken on line 13—13 of FIG. 12.

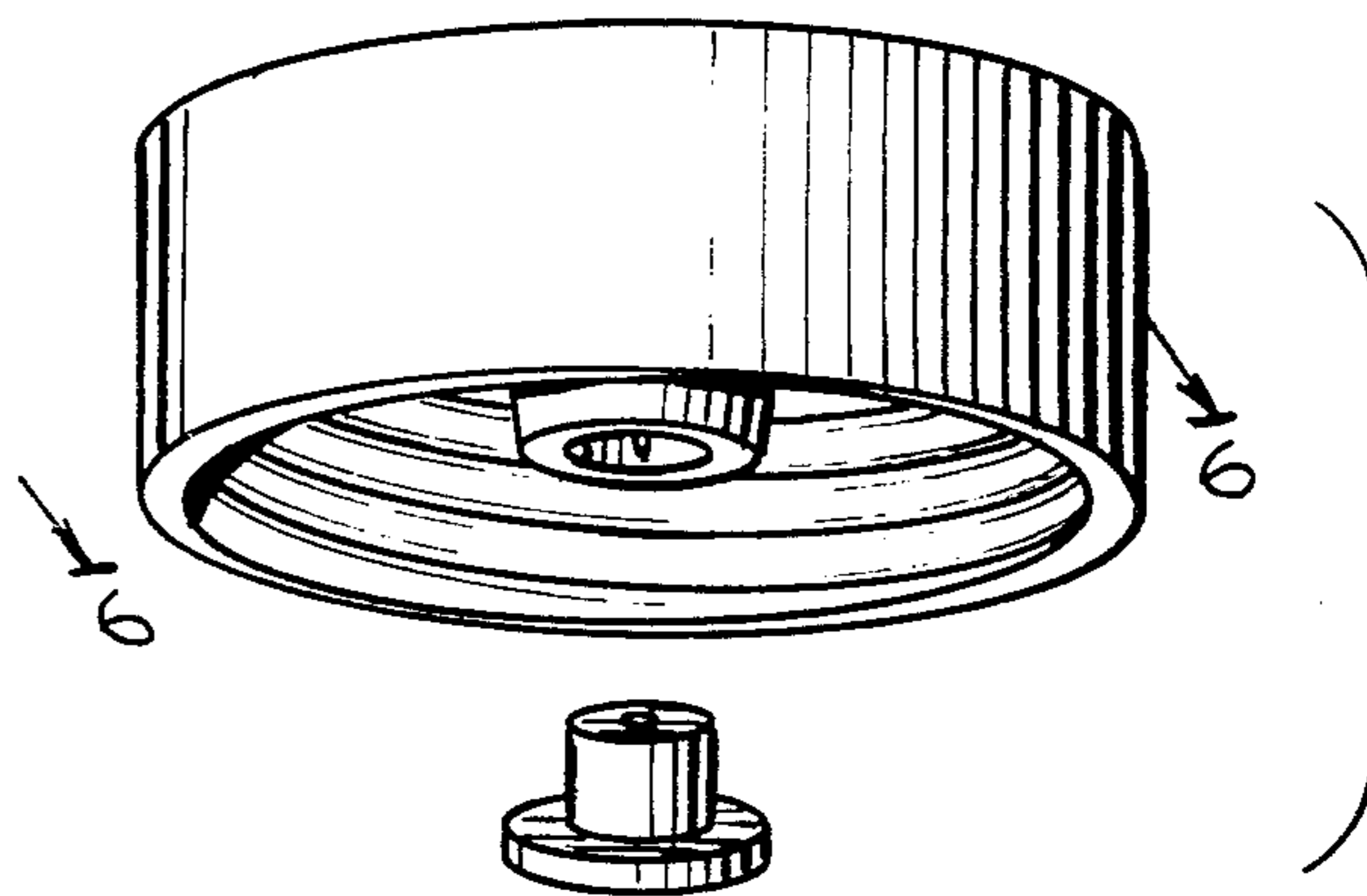
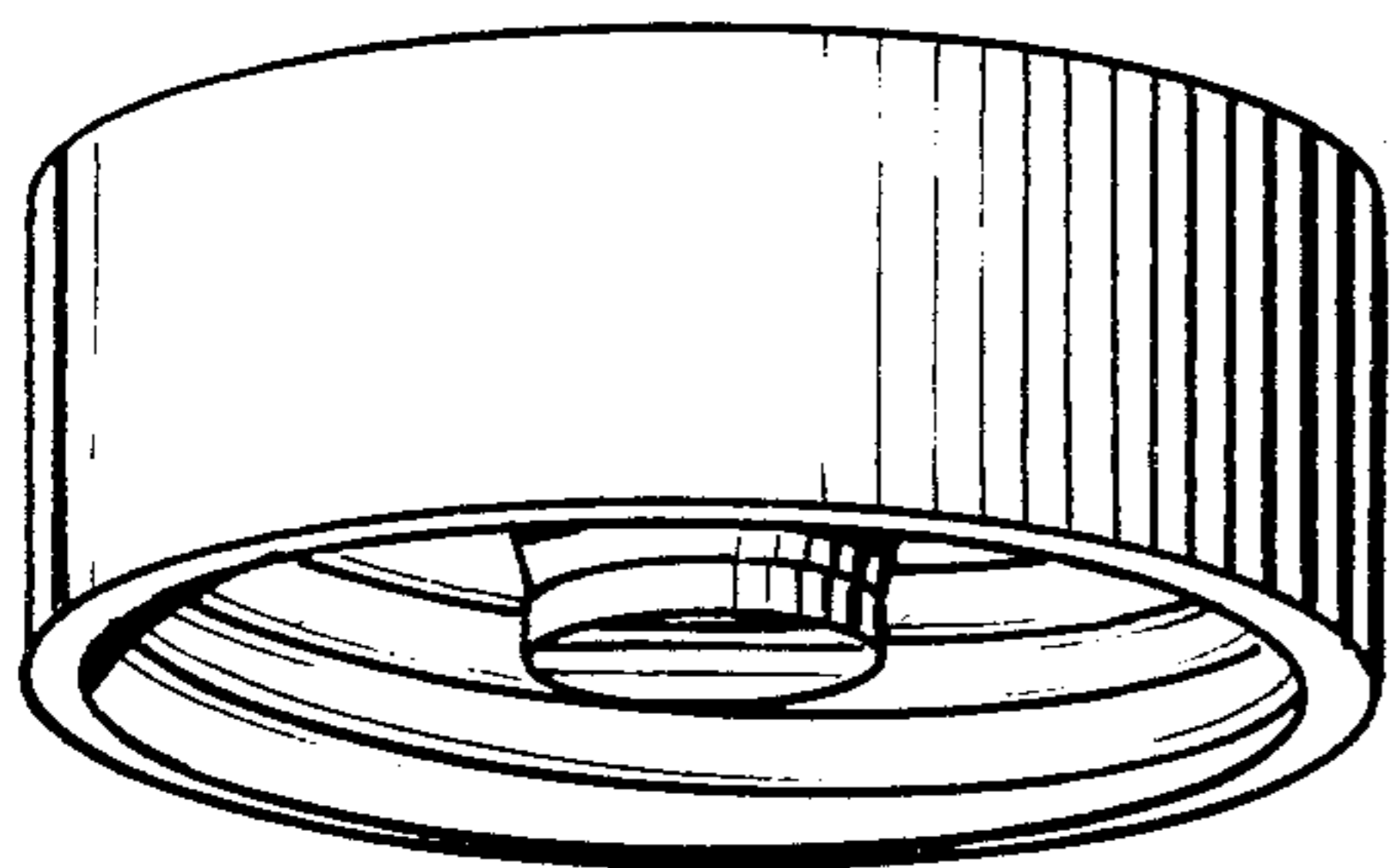

Fig. 1.

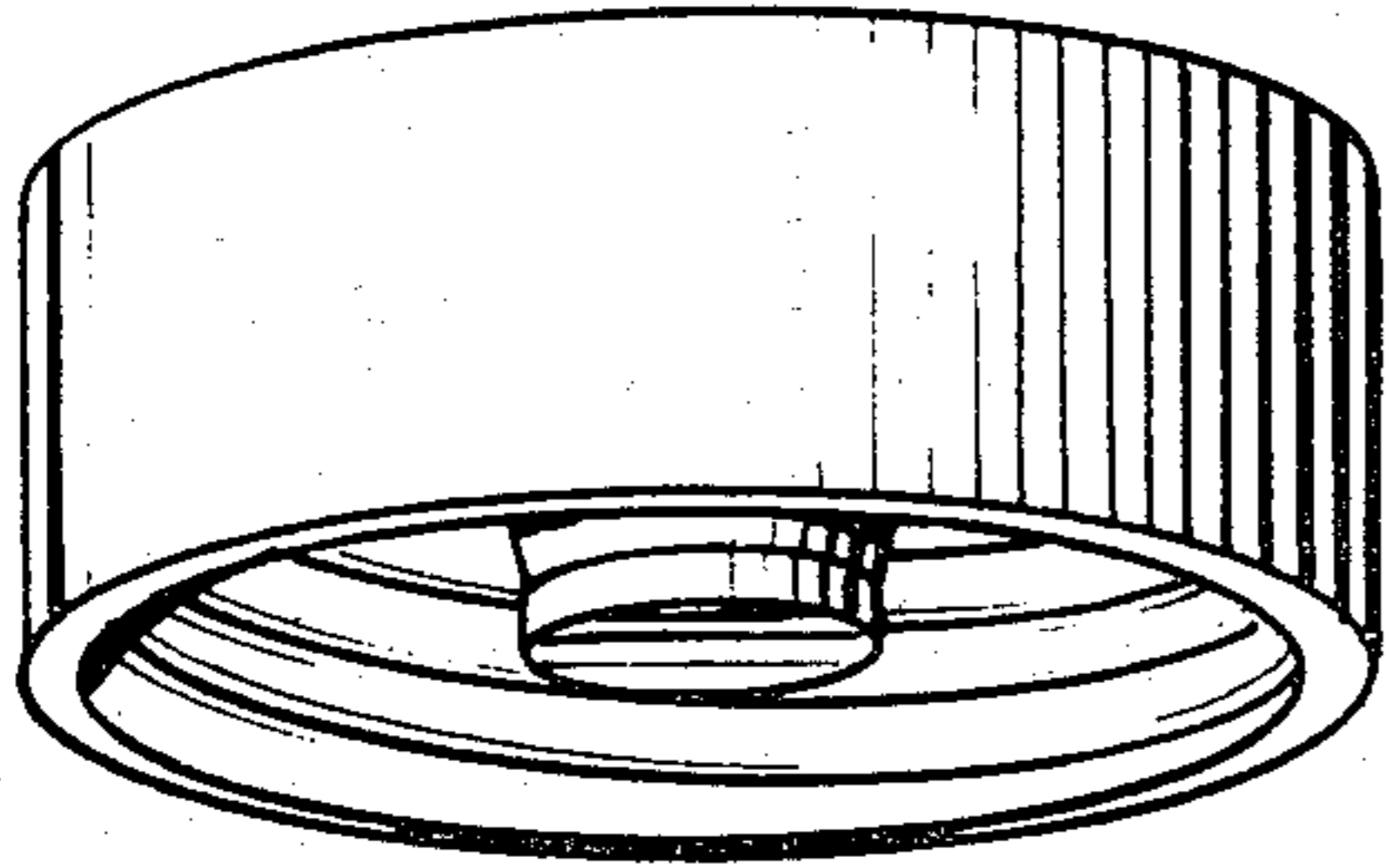

Fig. 2.

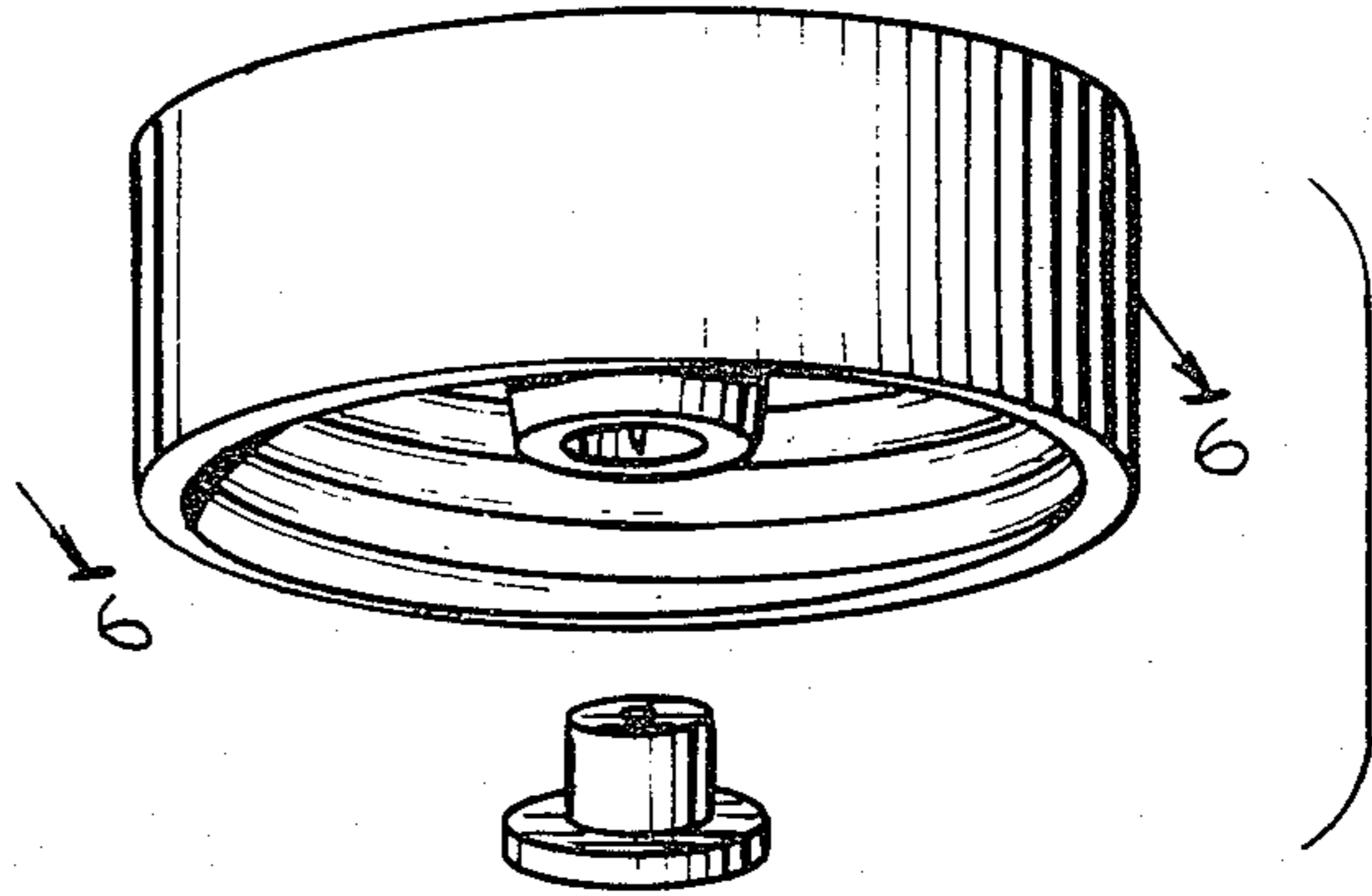

Fig. 3.

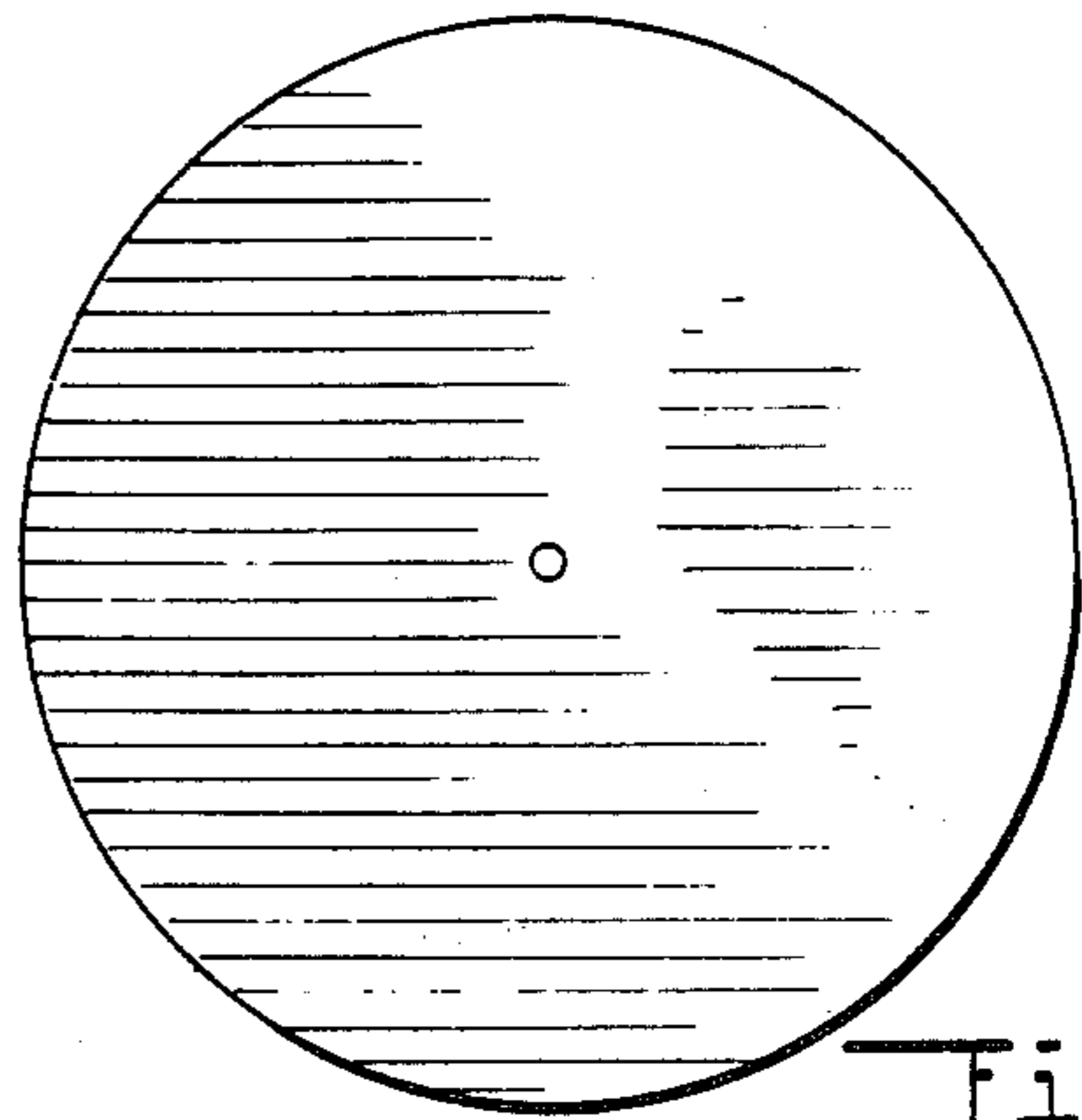
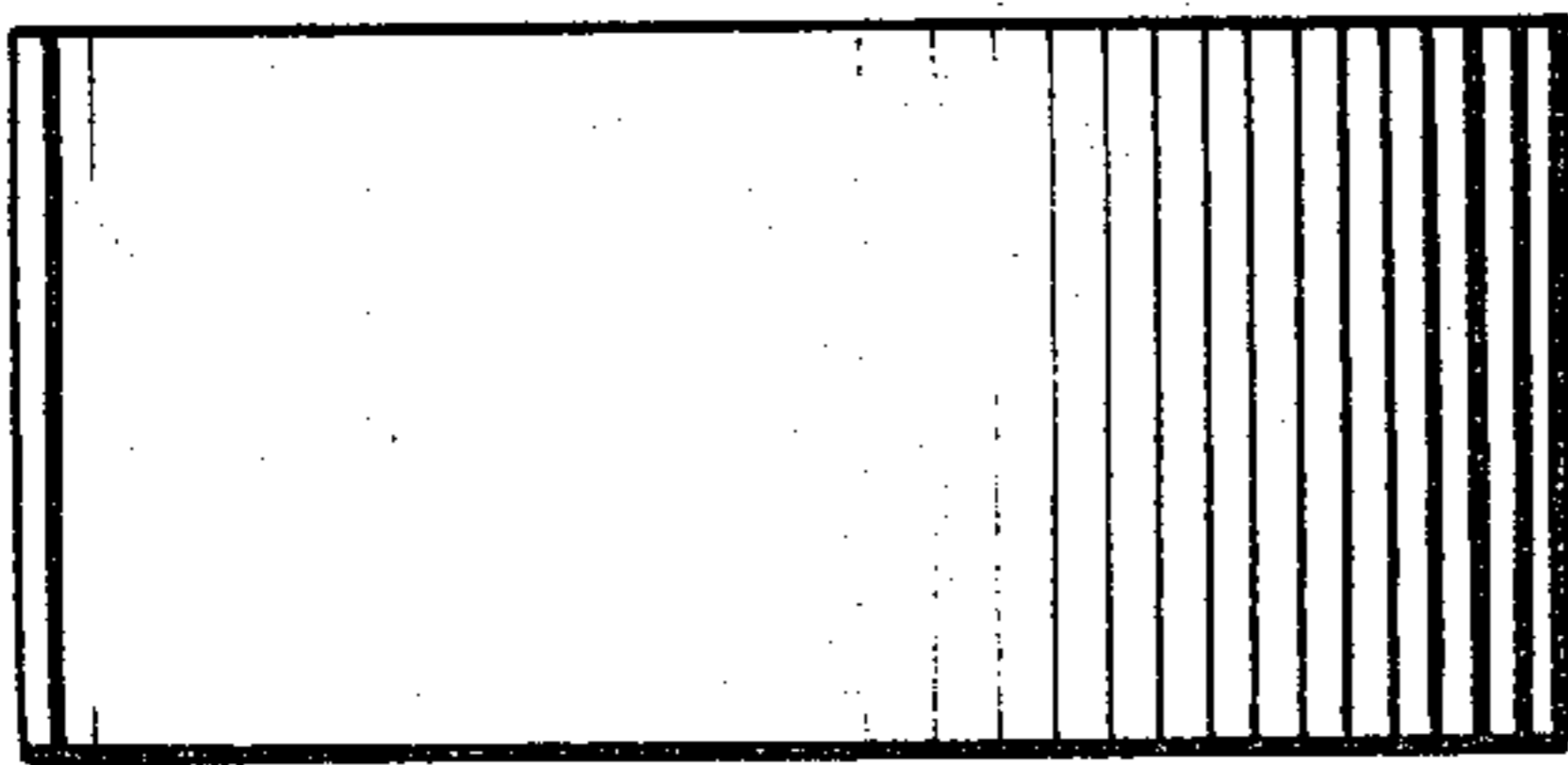

Fig. 4.

Fig. 5.

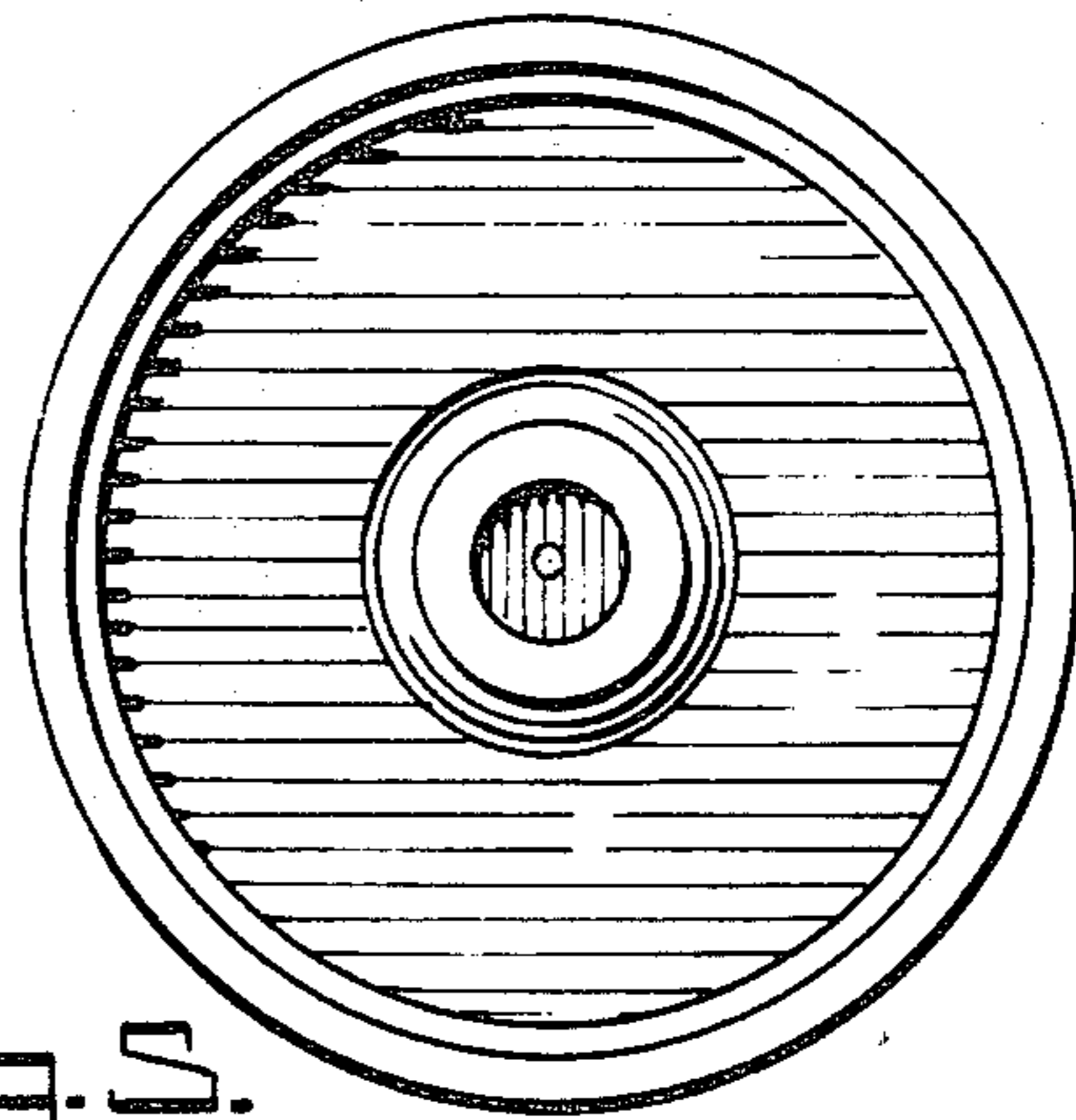
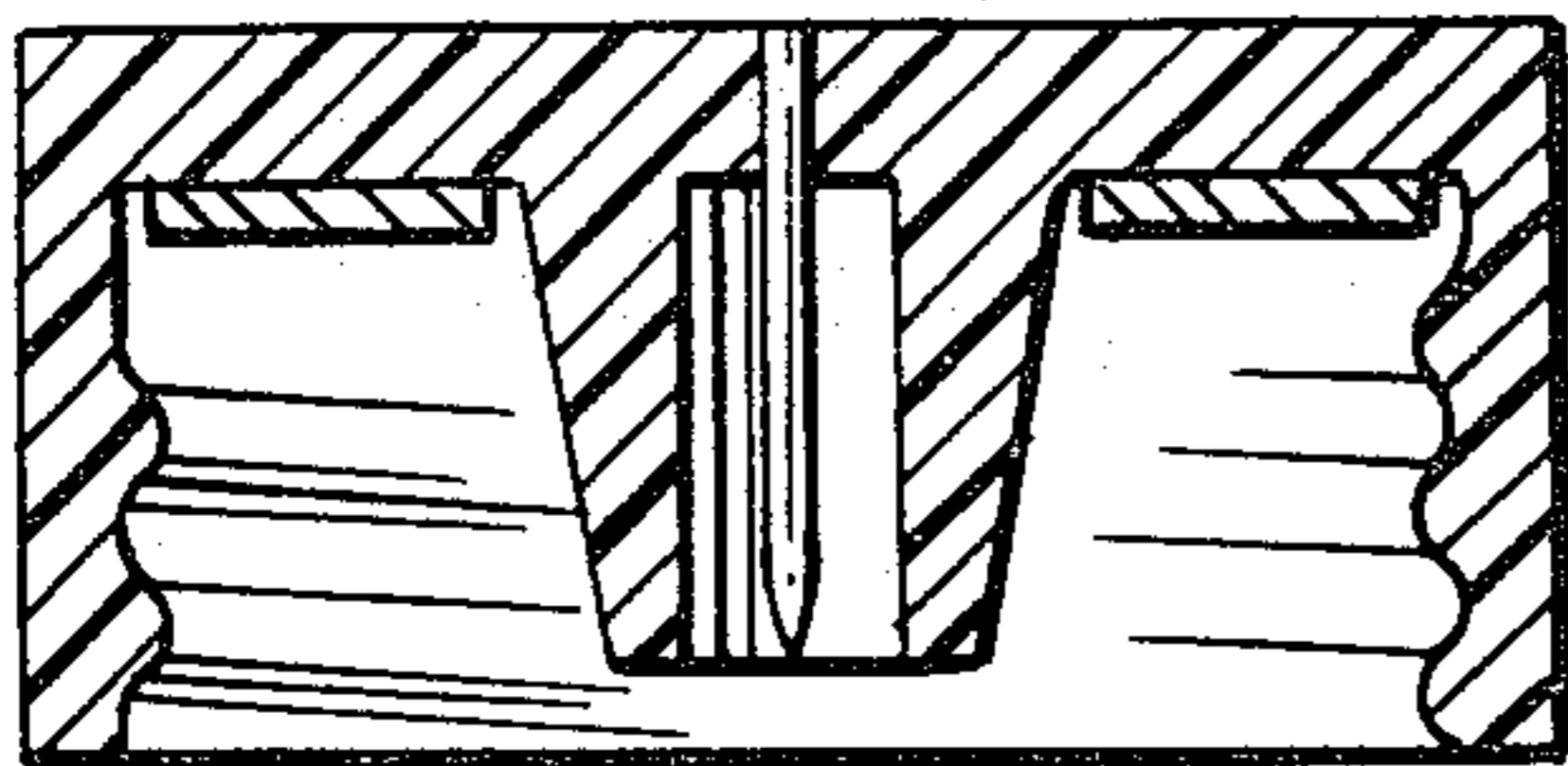

Fig. 5.

Fig. 7.

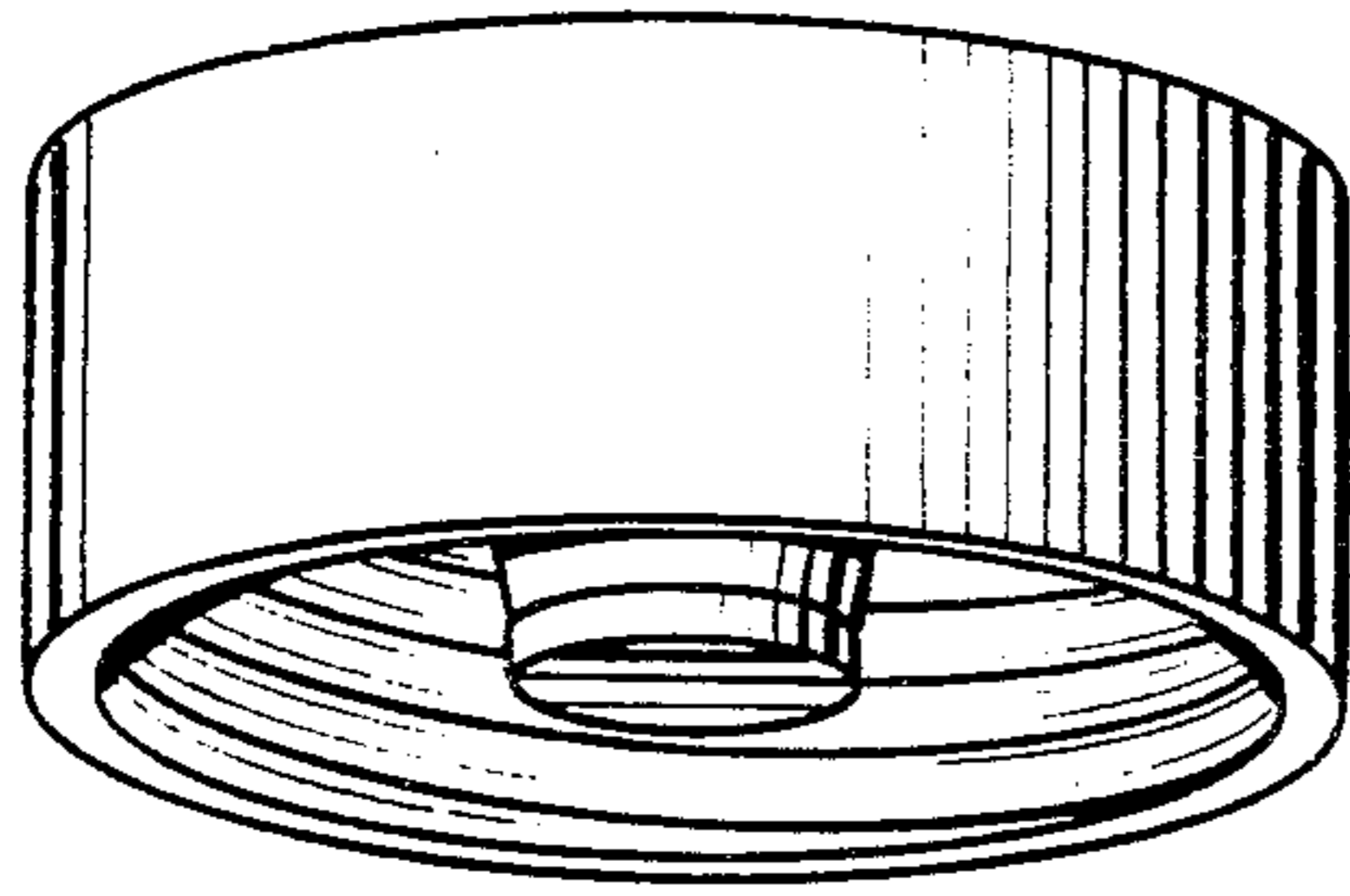

Fig. 8.

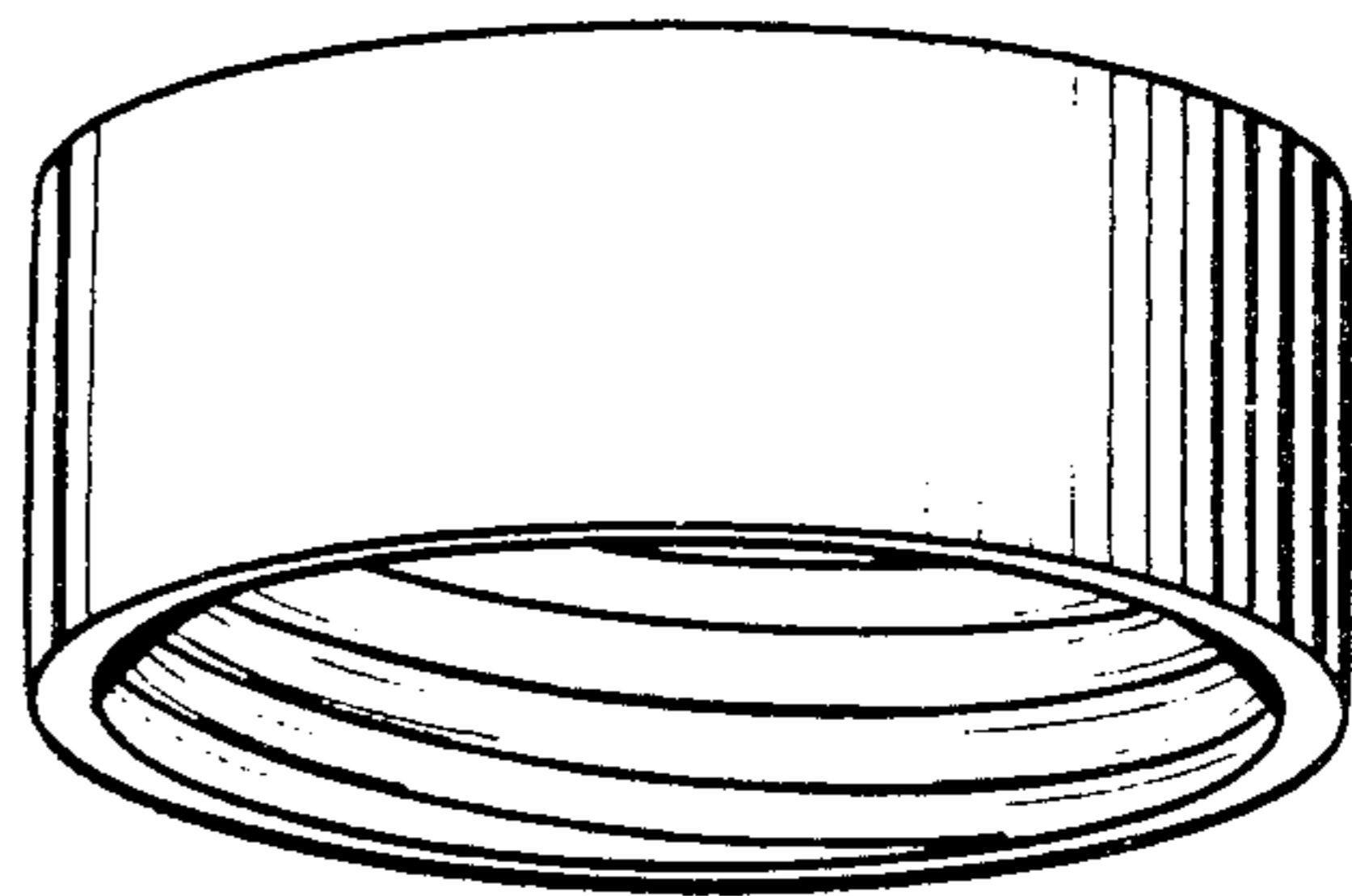

Fig. 9.

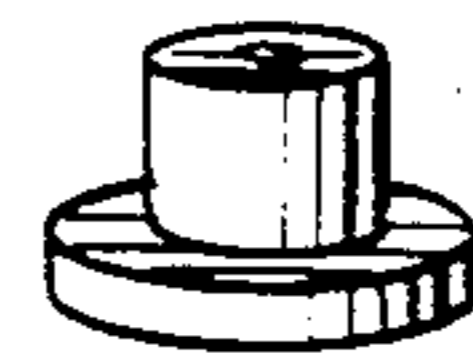
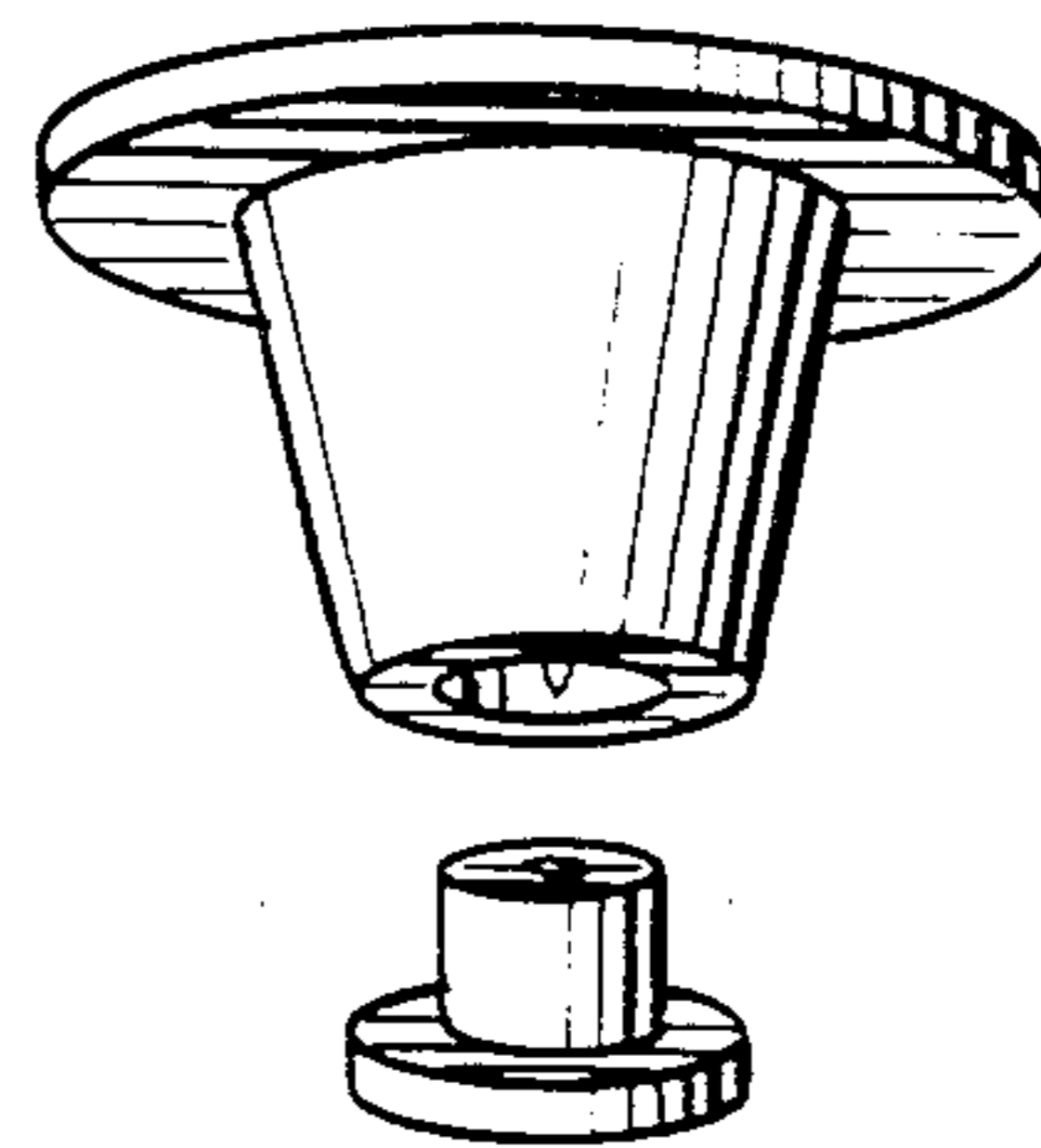
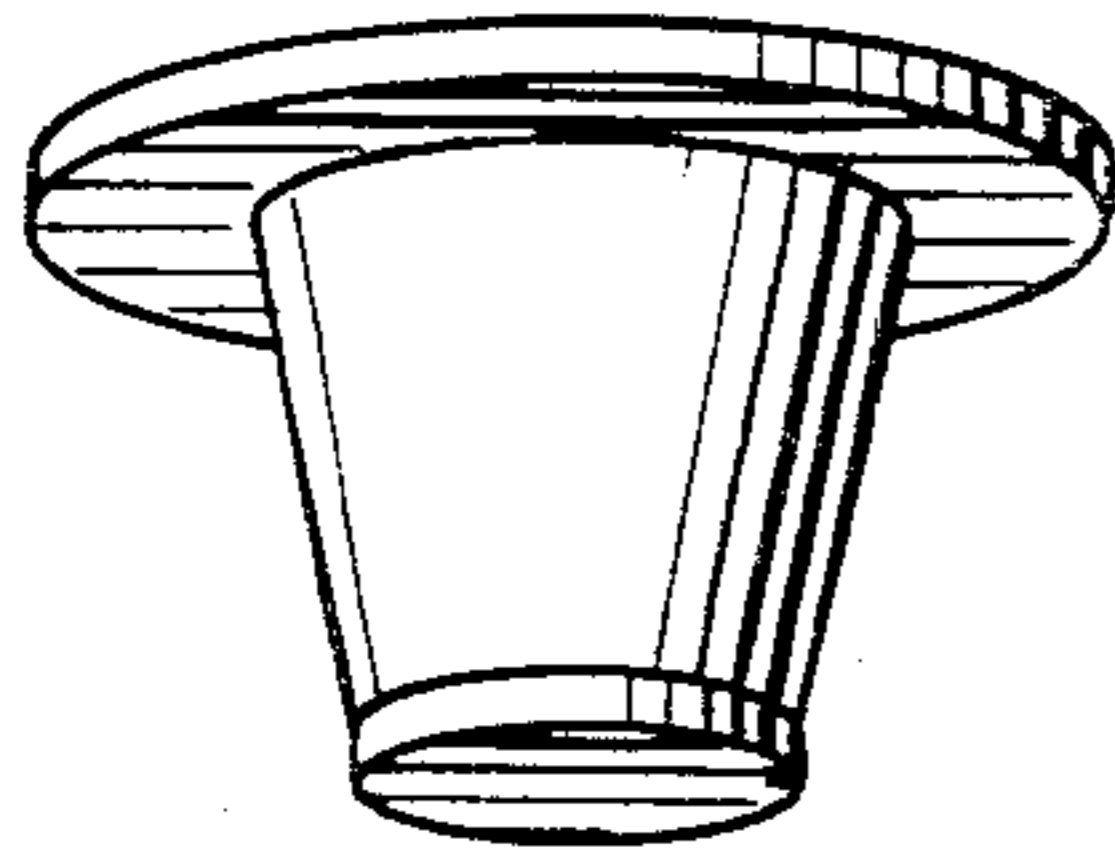

Fig. 10.

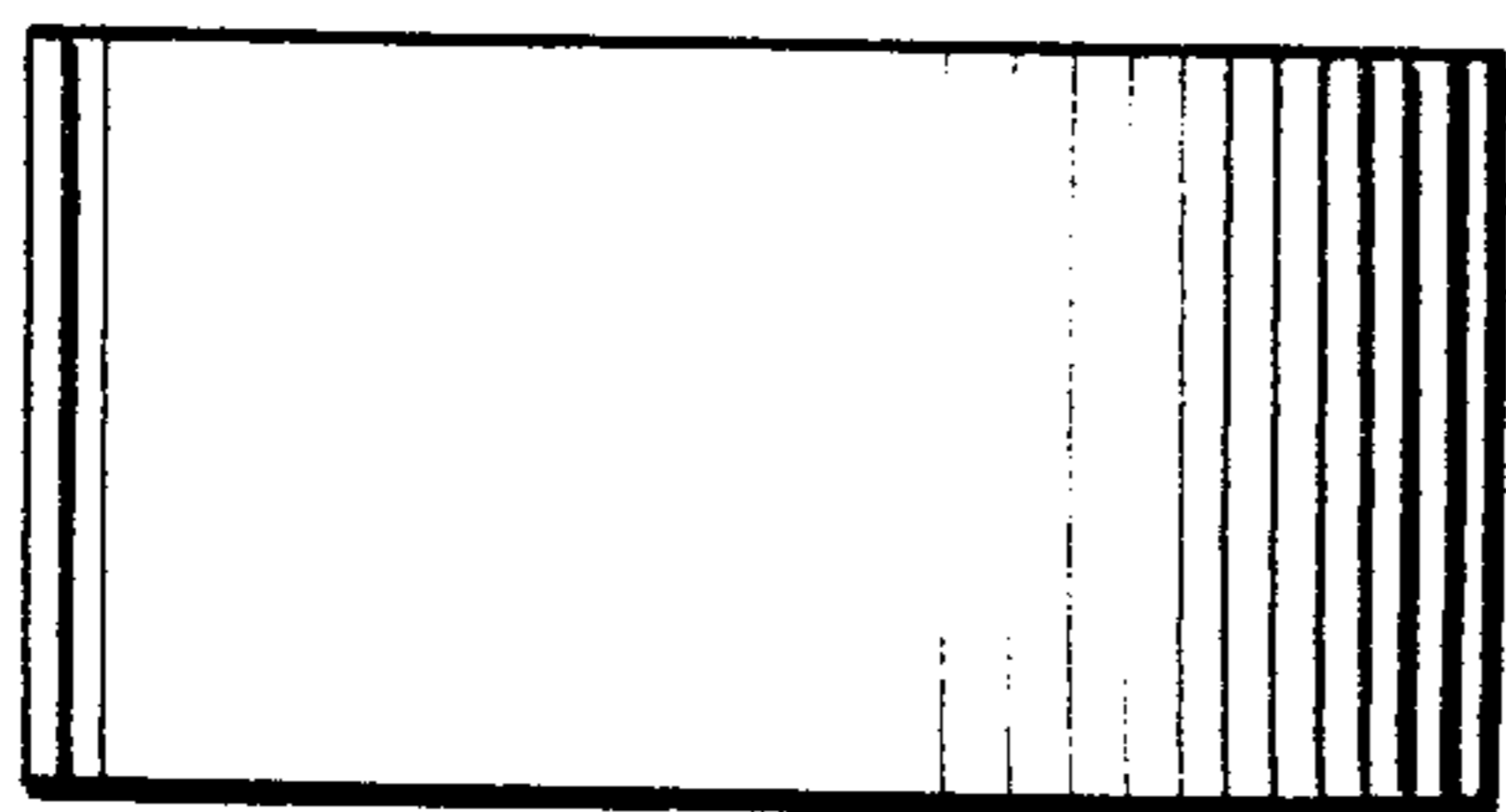

Fig. 11.

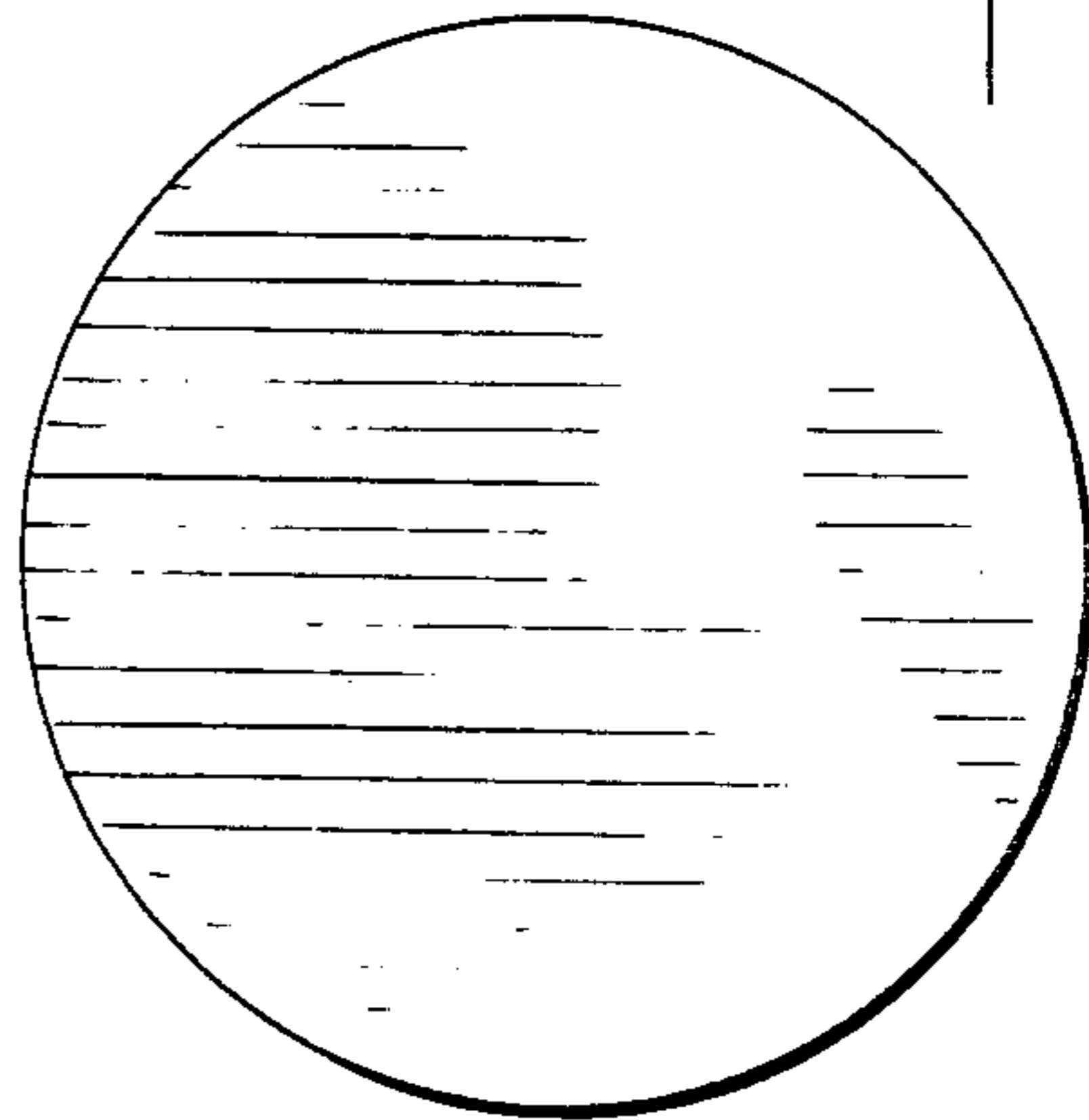
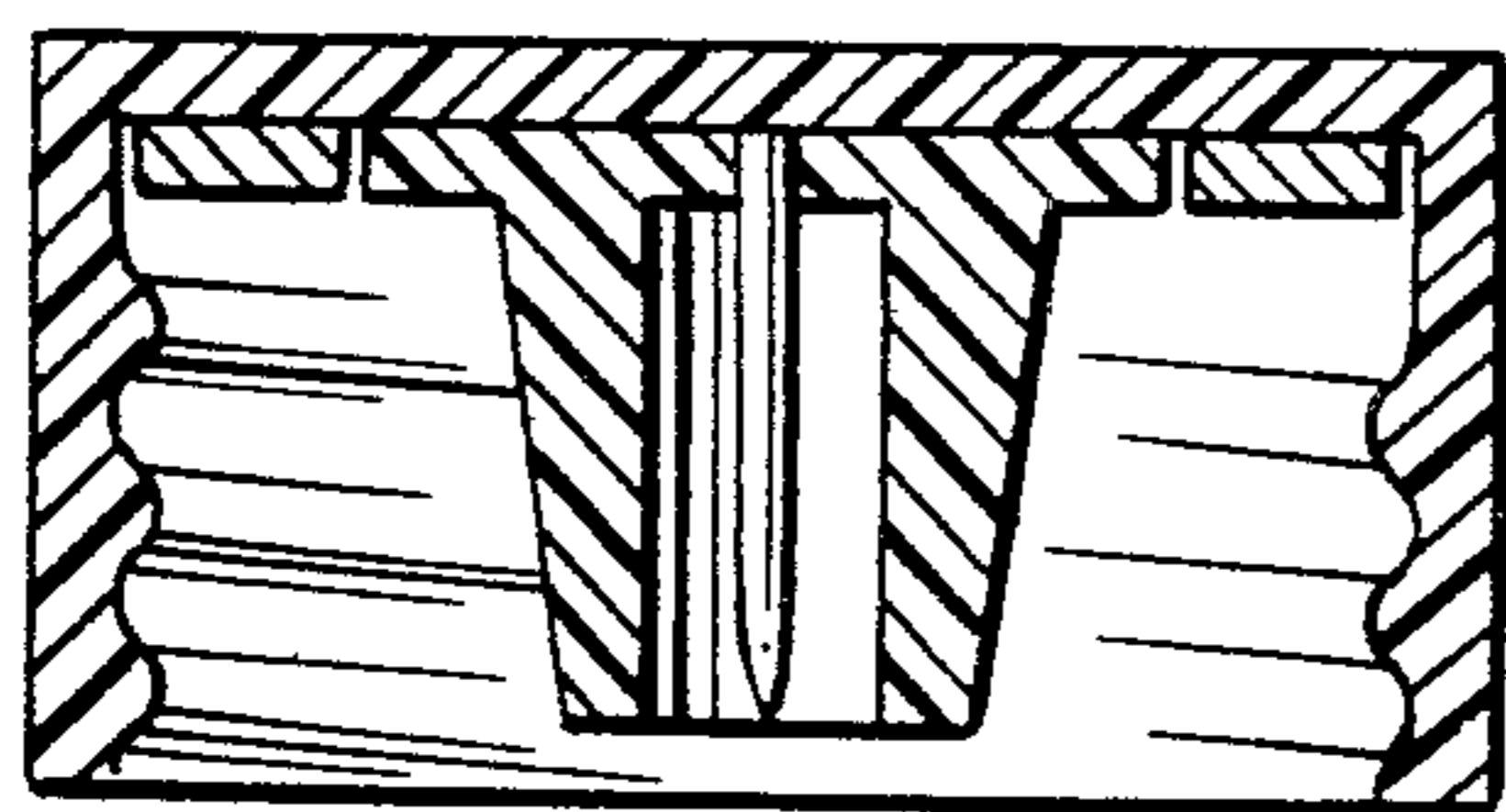

Fig. 13.



13

13

Fig. 12.

