

[54] INFLATABLE LOUNGE SEAT

3,408,107 10/1968 Savage D6/37 X

[76] Inventor: Carmelo J. Sigona, 51 Columbia Ave., Paterson, N.J.

Primary Examiner—Bruce W. Dunkins
Attorney, Agent, or Firm—M. K. Silverman; J. A. Giampapa

[**] Term: 14 Years

[57] CLAIM

[21] Appl. No.: 380,208

An inflatable seat, substantially shown and described.

[22] Filed: May 20, 1982

DESCRIPTION

[52] U.S. Cl. D6/361; D6/604

[58] Field of Search D6/1, 37, 38, 39, 67, D6/79, 80; 297/456

FIG. 1 is a perspective view showing a second embodiment of a portable inflatable lounge seat of this invention distinguished from the first embodiment by including a leg rest;

[56] References Cited

U.S. PATENT DOCUMENTS

- D. 167,666 9/1952 Argento D6/1
- D. 220,952 6/1971 Petersen et al. D6/37 X
- D. 249,304 9/1978 Nash D6/37
- D. 256,408 8/1980 Nakisbendi D6/37
- D. 264,646 6/1982 Shauan D6/37

FIG. 2 is a top plan view of FIG. 1 hereof;
FIG. 3 is a side elevational view of FIG. 1 hereof;
FIG. 4 is a front elevational view of FIG. 1 hereof;
FIG. 5 is a rear elevational view of FIG. 1 hereof;
FIG. 6 is a bottom plan view of FIG. 1 hereof; and,
FIG. 7 is a perspective view of the second embodiment in deflated condition.

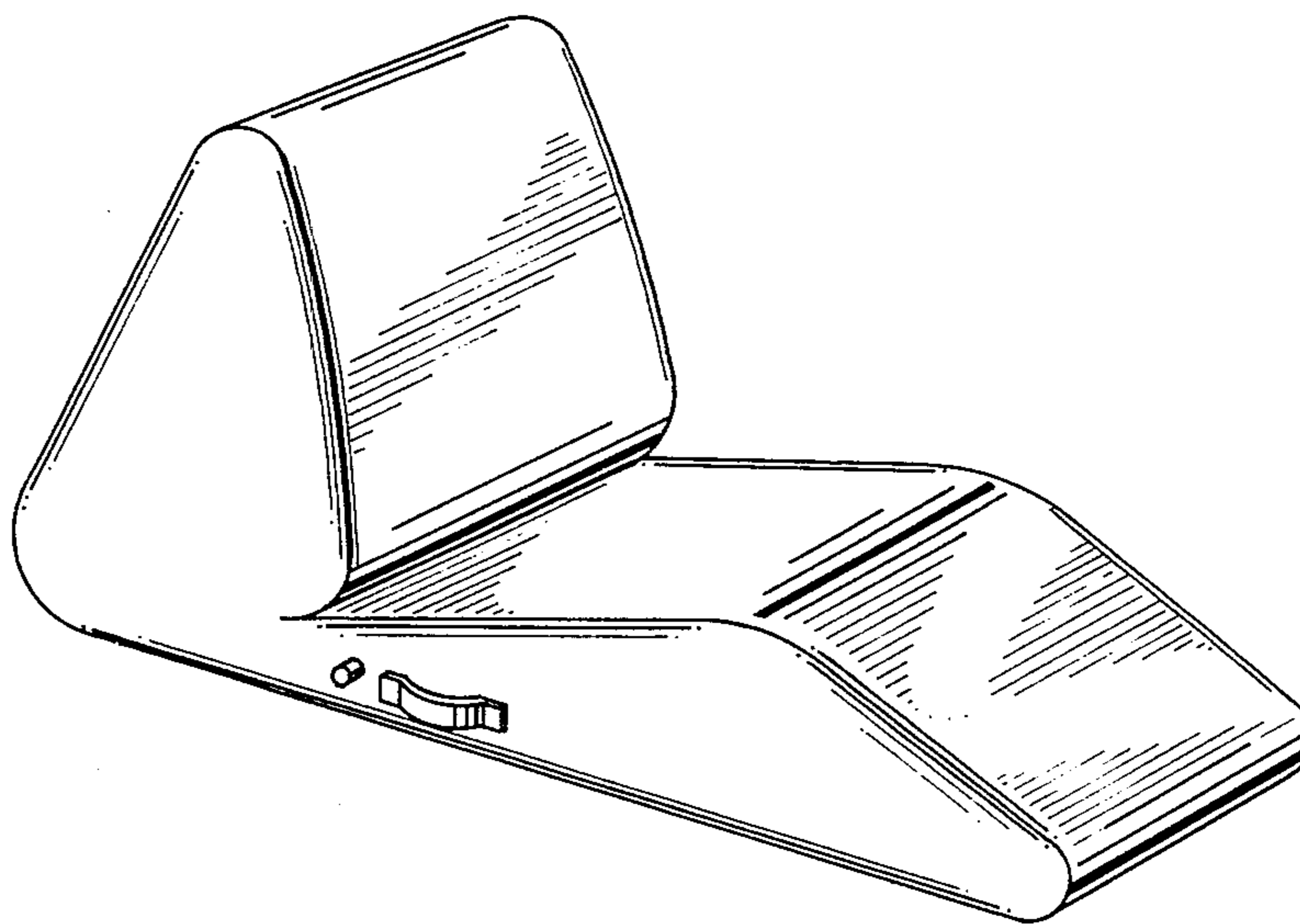

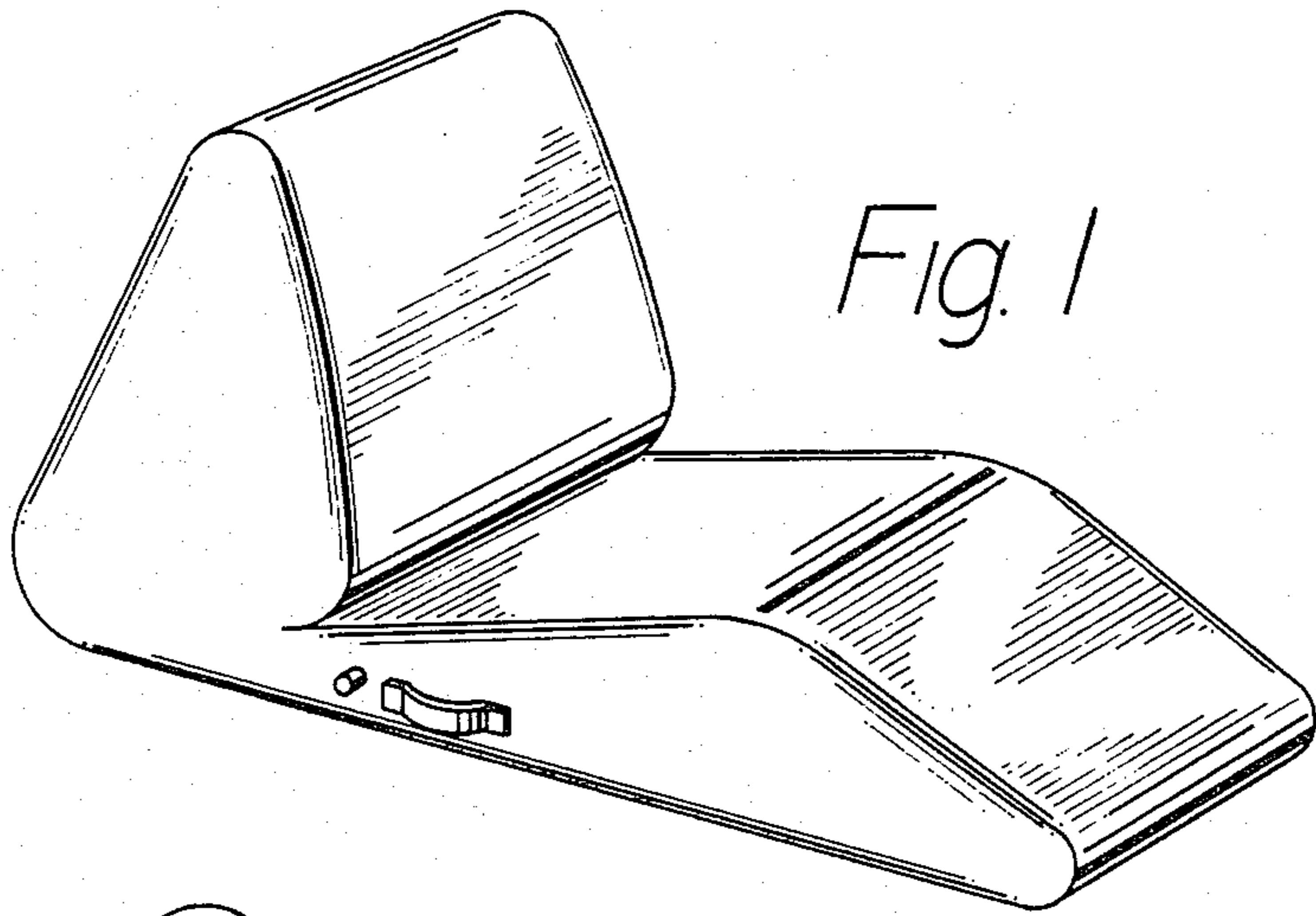

Fig. 1

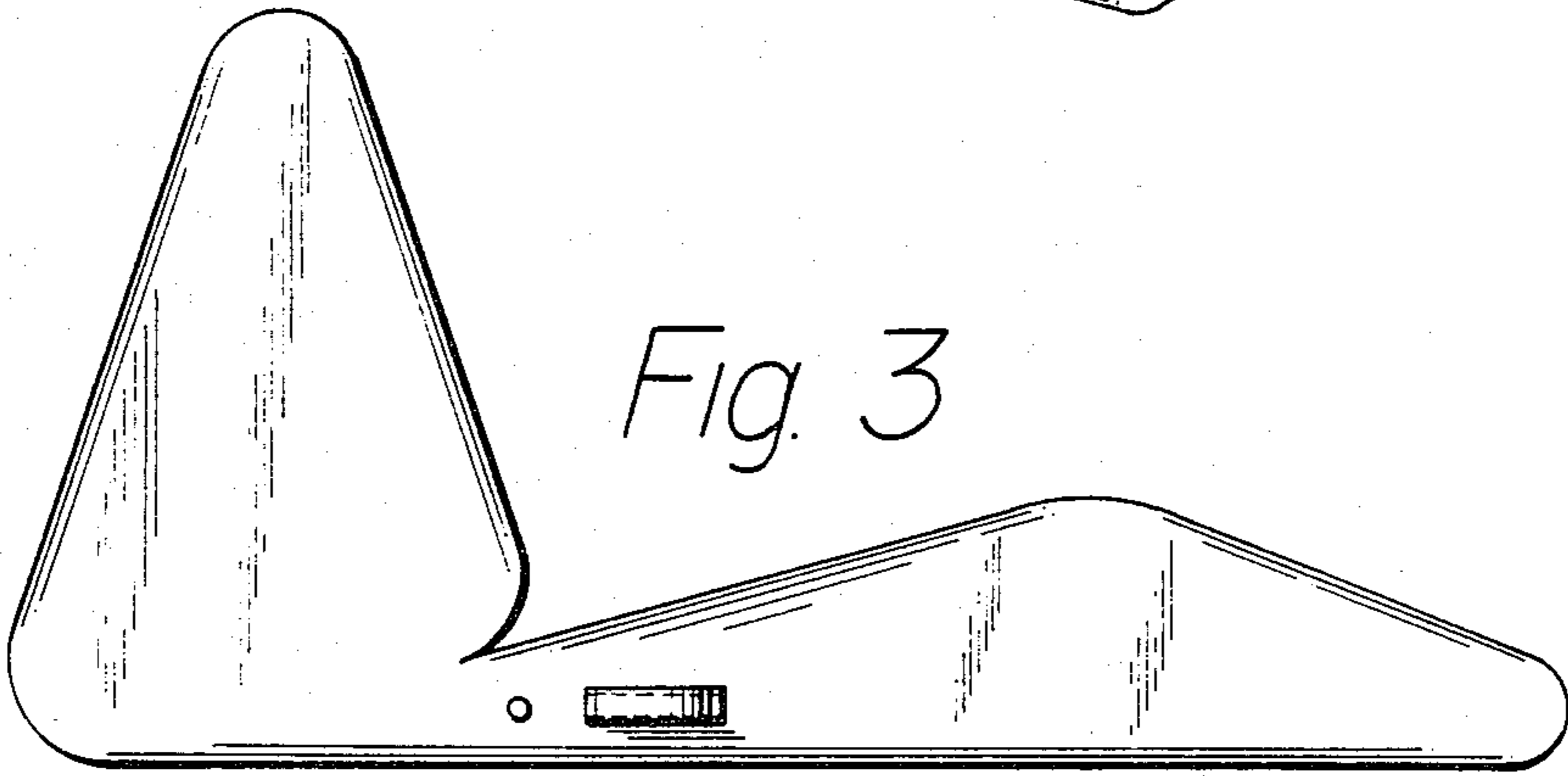

Fig. 3

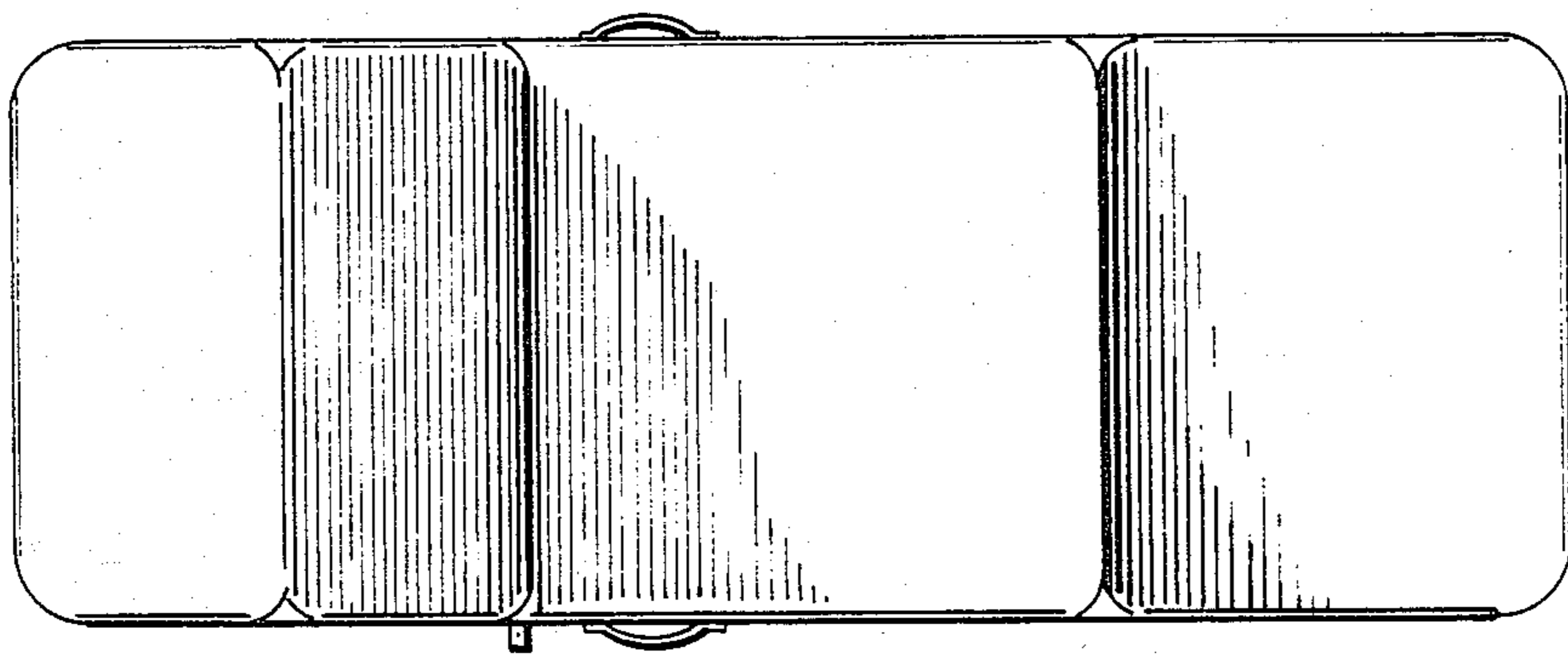

Fig. 2

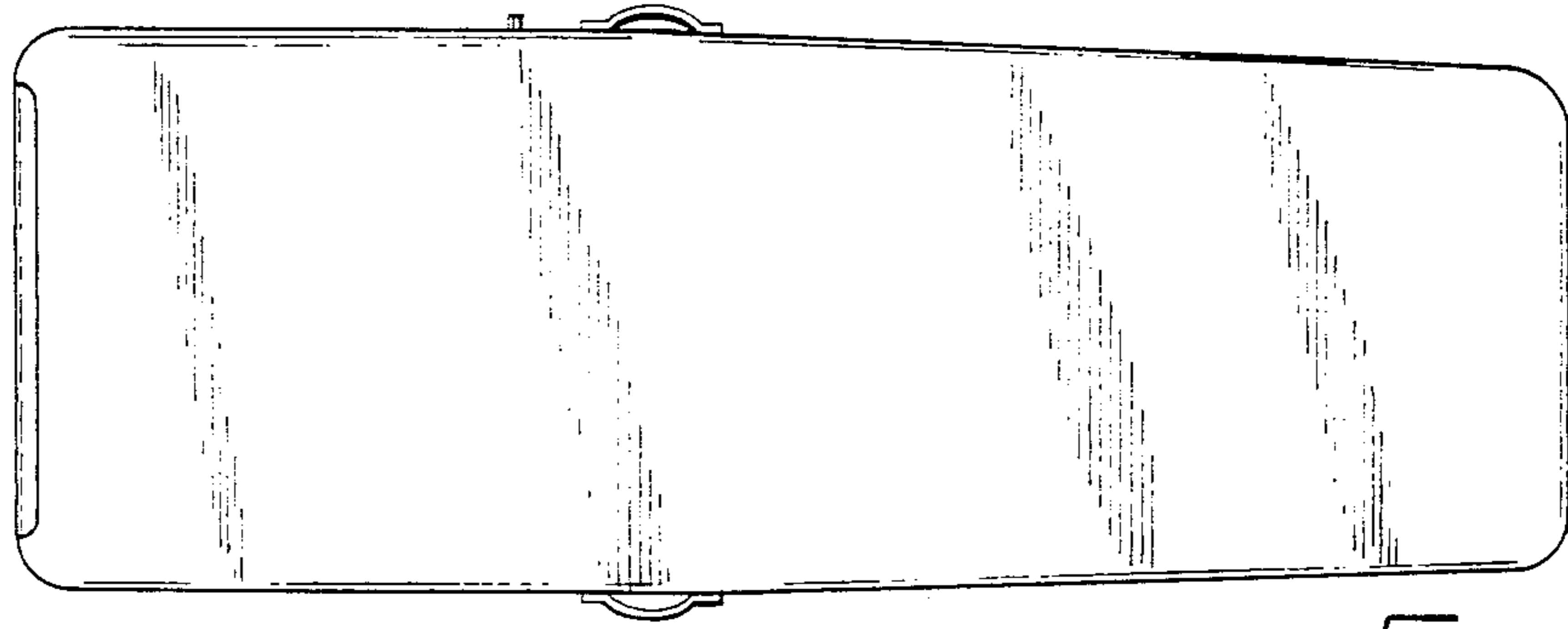

Fig. 6

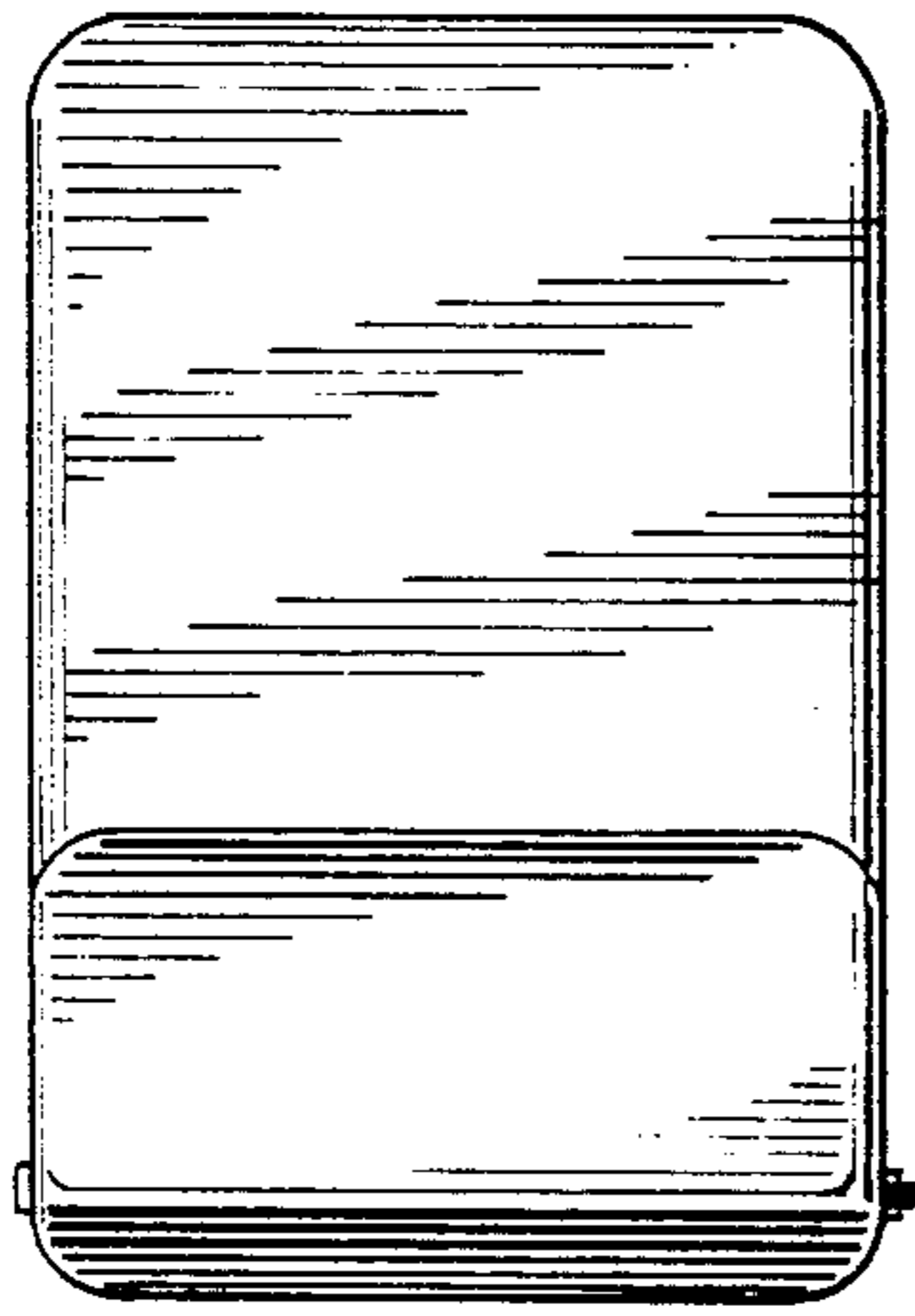

Fig. 4

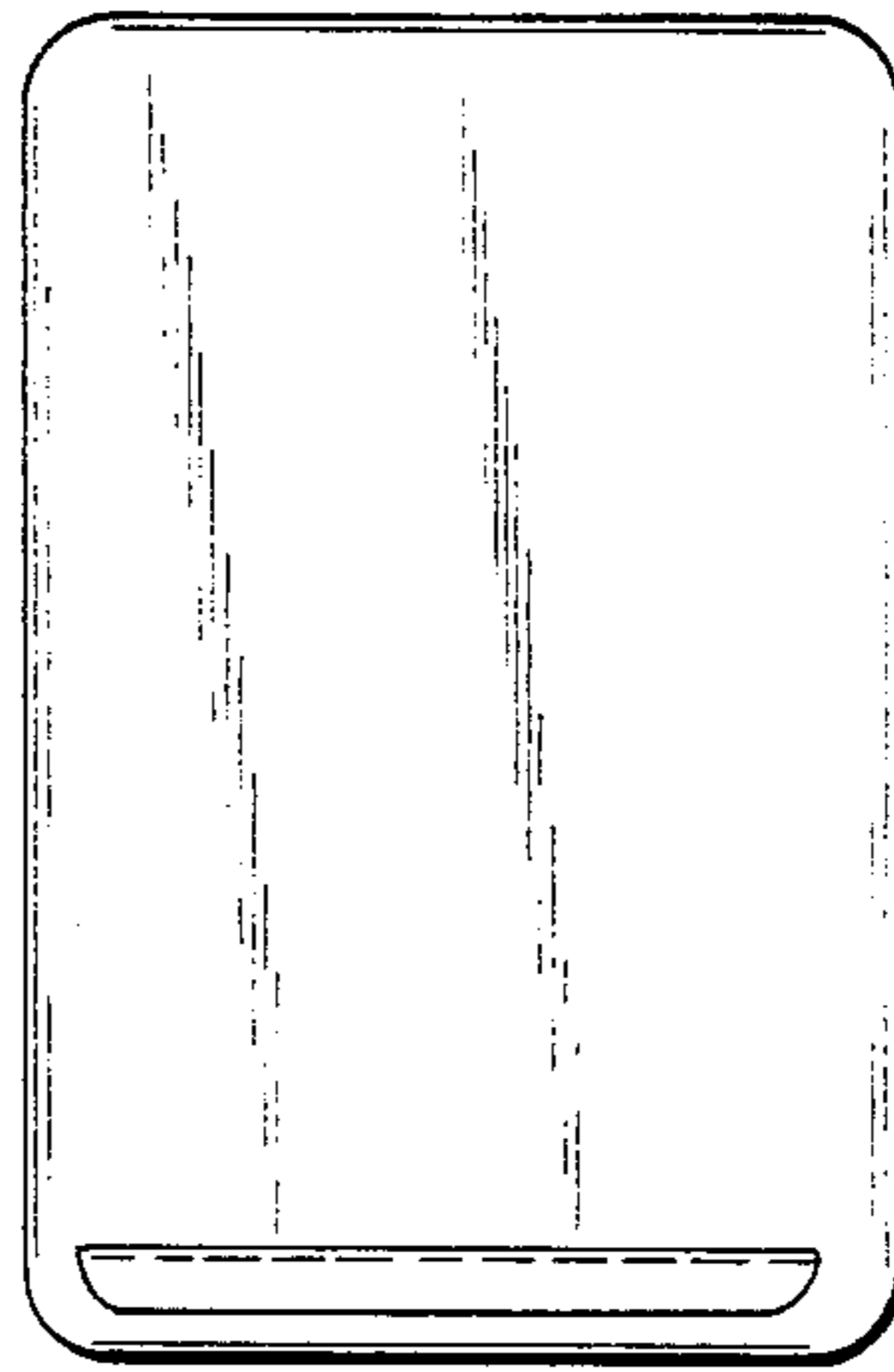

Fig. 5

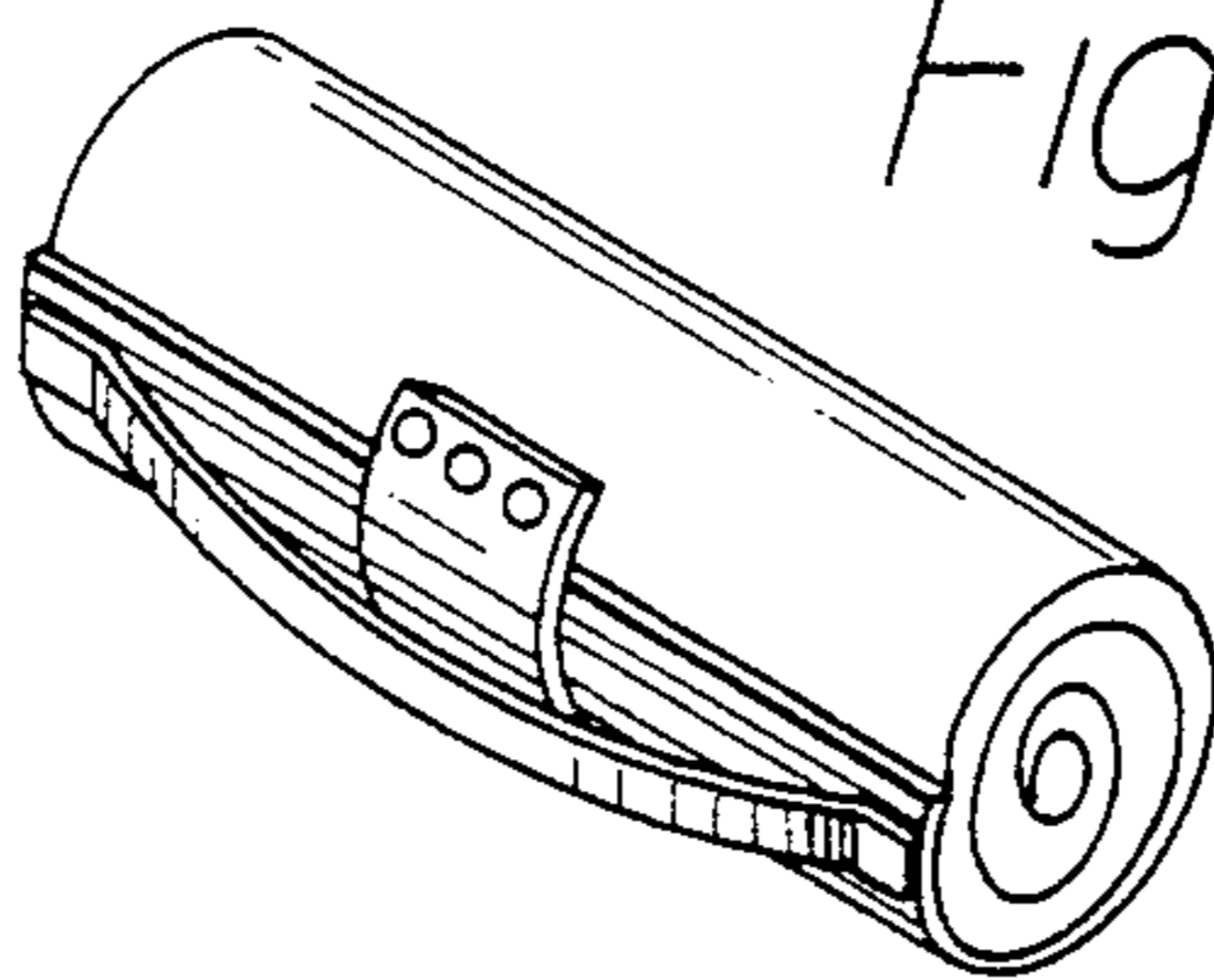

Fig. 7