

# United States Patent [19]

Shimizu et al.

[11] Patent Number: **Des. 277,961**

[45] Date of Patent: **\*\* Mar. 12, 1985**

[54] TELEVISION CAMERA

[75] Inventors: **Norio Shimizu, Inagi; Hiroshi Osaka,**  
Kunitachi, both of Japan

[73] Assignee: **Koyo Electronics Industries Co., Ltd.,**  
Tokyo, Japan

[\*\*] Term: **14 Years**

[21] Appl. No.: **444,461**

[22] Filed: **Nov. 24, 1982**

[52] U.S. Cl. .... **D14/78**

[58] Field of Search ..... **D14/78; D16/3, 4**

[56] **References Cited**

## U.S. PATENT DOCUMENTS

D. 203,233 12/1965 Olson ..... D16/3

D. 210,502 3/1968 Caldwell ..... D16/3

D. 227,504 6/1973 Lang ..... D14/78

*Primary Examiner*—Jane E. Corrigan

*Attorney, Agent, or Firm*—George B. Oujevolk

## [57] CLAIM

The ornamental design for a television camera, as shown and described.

## DESCRIPTION

FIG. 1 is a front elevational view of a television camera showing our new design;

FIG. 2 is a rear elevational view;

FIG. 3 is a top plan view;

FIG. 4 is a bottom plan view;

FIG. 5 is a right side elevational view;

FIG. 6 is a left side elevational view; and

FIG. 7 is a front, top and right side perspective view.

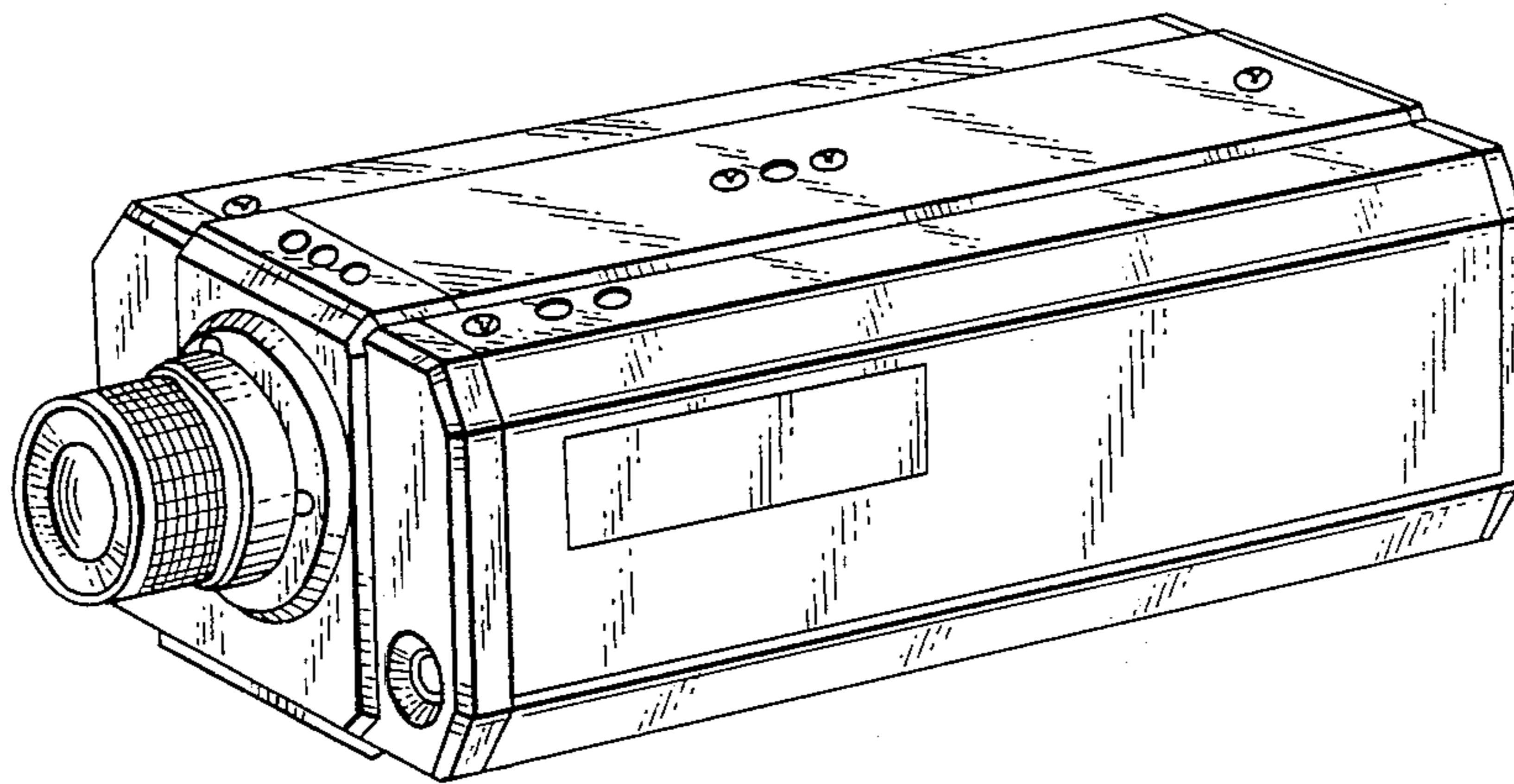

FIG. 1

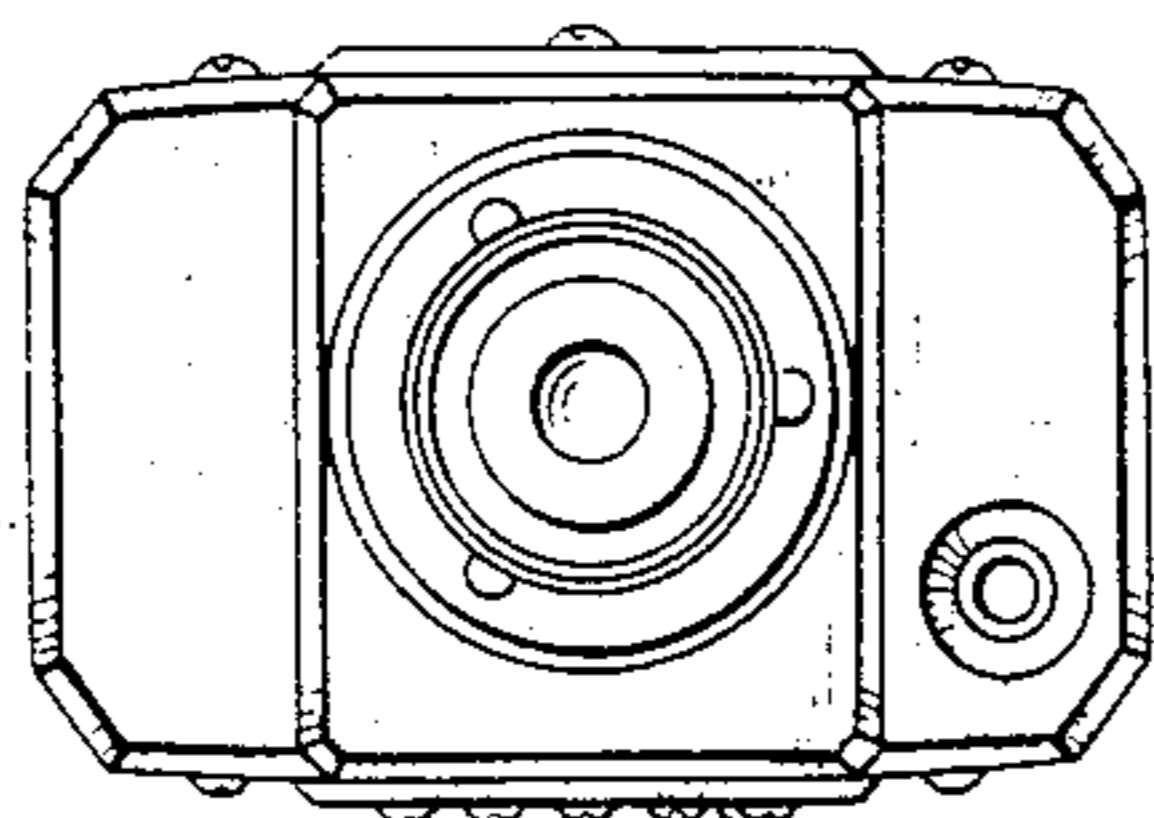

FIG. 2

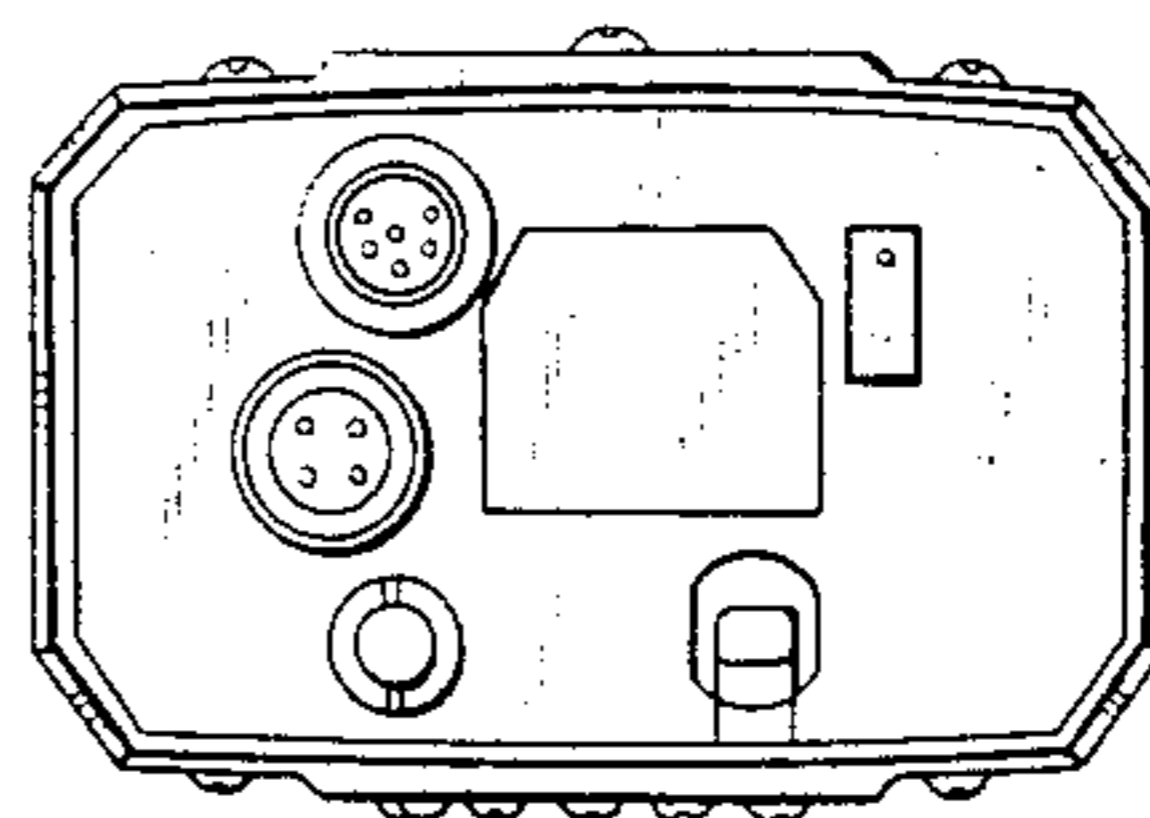

FIG. 3

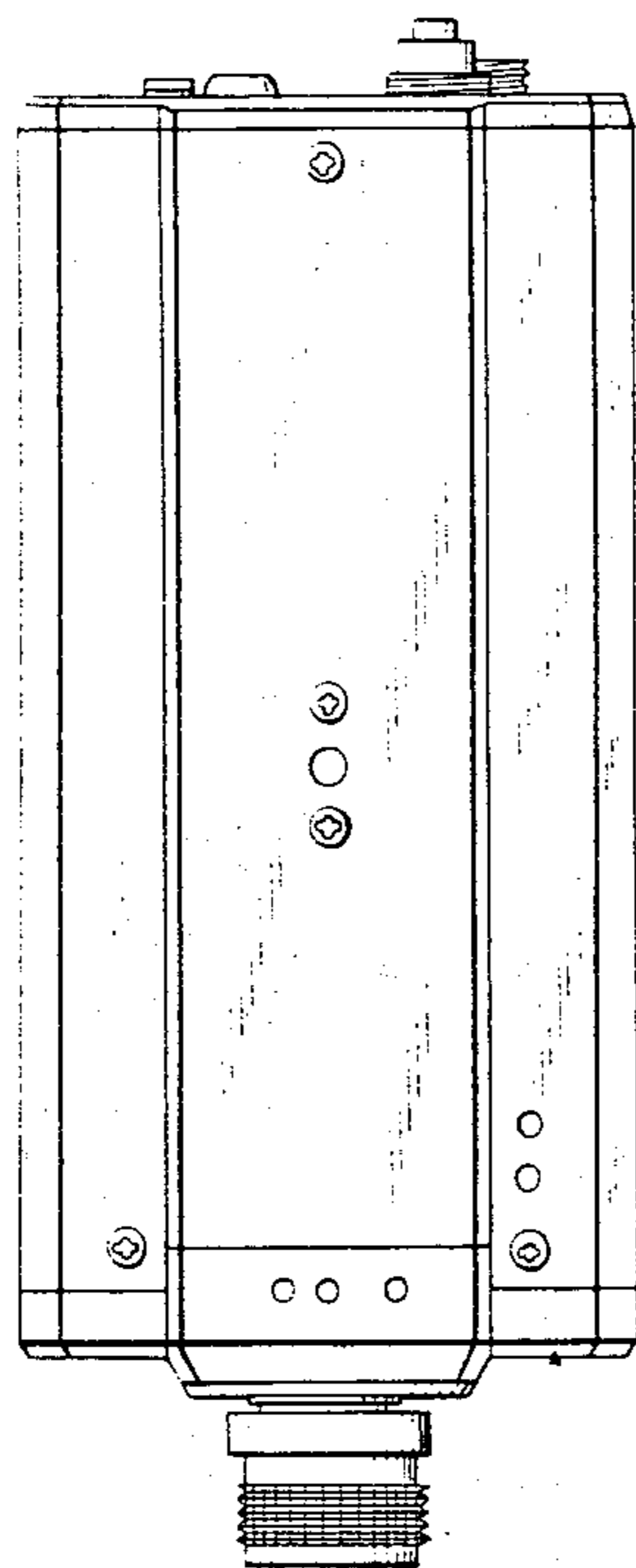

FIG. 4

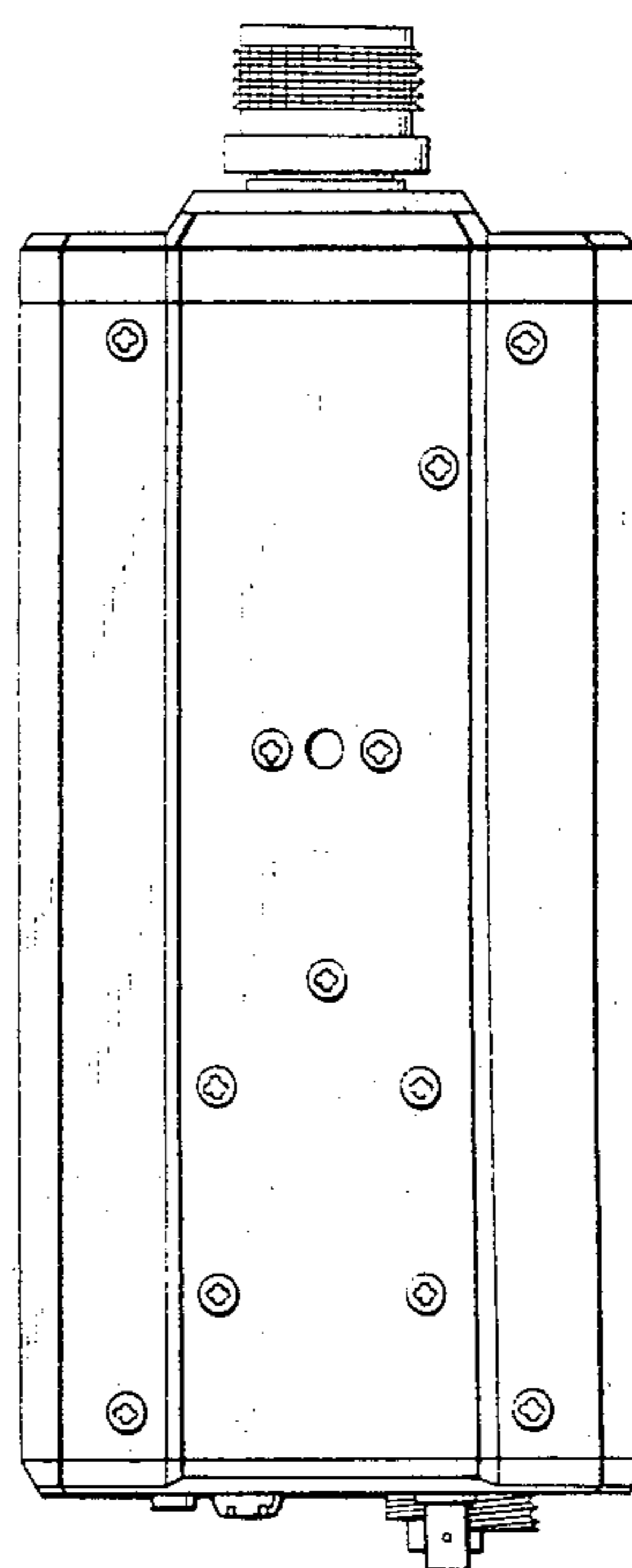

FIG. 5

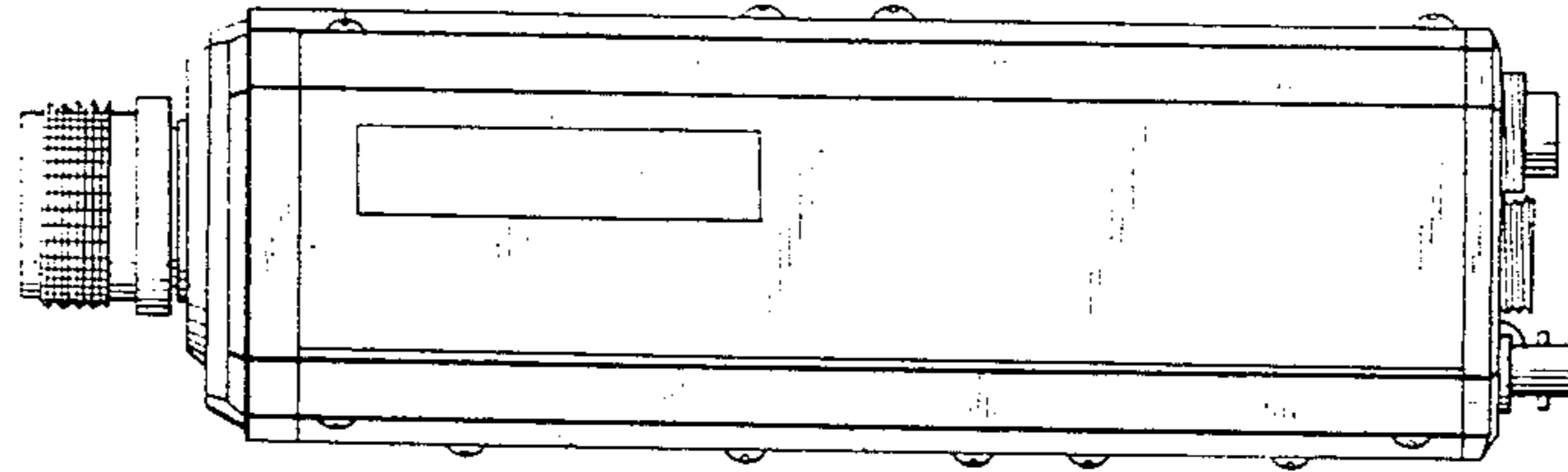

FIG. 6

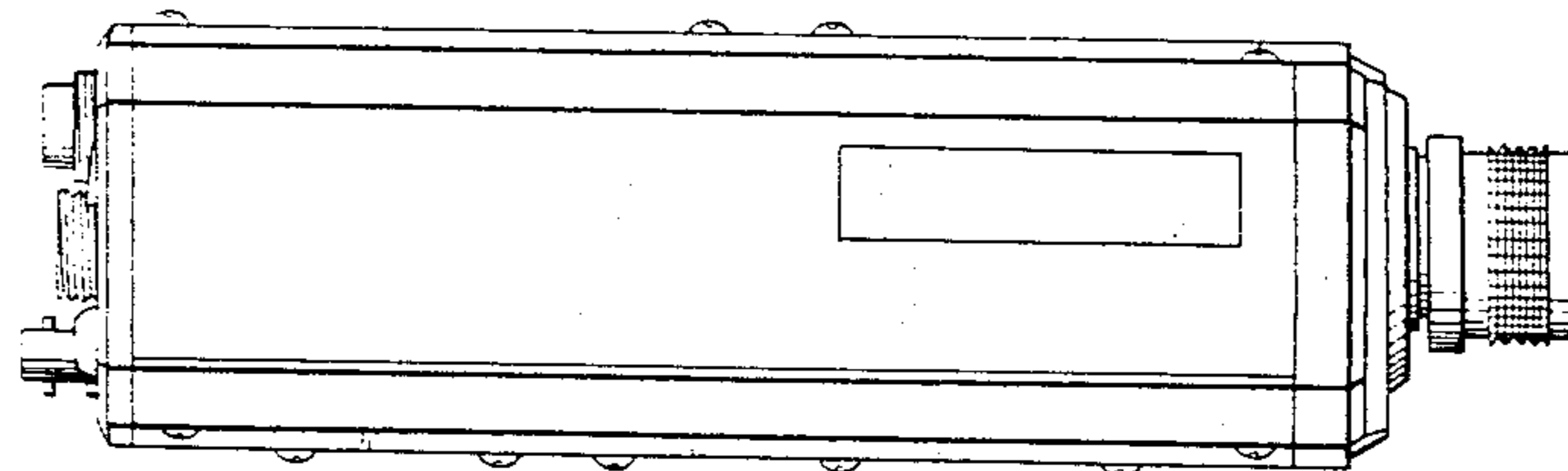

FIG. 7

