

[54] **TAIL PIECE FOR A BANJO**

[76] **Inventor: Gary H. Price, 1117 Denmark, Grand Prairie, Tex. 75050**

[\*\*] **Term: 14 Years**

[21] **Appl. No.: 404,634**

[22] **Filed: Aug. 2, 1982**

[52] **U.S. Cl. .... D17/21**

[58] **Field of Search ..... D17/14, 15, 19, 20, D17/21; 84/267, 269, 300**

[56] **References Cited**

**U.S. PATENT DOCUMENTS**

D. 191,139	8/1961	Baker	.....	D17/21
1,721,153	7/1929	Grover et al.	.....	84/300
4,377,962	3/1983	Parker	.....	84/300 X

**OTHER PUBLICATIONS**

*The Music Trades*, 1-6-26, p. 39, Waverly Tenor Banjo Extension Tailpiece, #B1675.

*Primary Examiner*—Jane E. Corrigan  
*Attorney, Agent, or Firm*—Charles W. McHugh

[57] **CLAIM**

The ornamental design for a tail piece for a banjo, as shown and described.

**DESCRIPTION**

FIG. 1 is a top plan view of a tail piece for a banjo showing my new design;  
FIG. 2 is a front elevational view thereof;  
FIG. 3 is a right side elevational view, the left side being a mirror image thereof;  
FIG. 4 is a rear elevational view thereof; and  
FIG. 5 is a bottom plan view thereof.

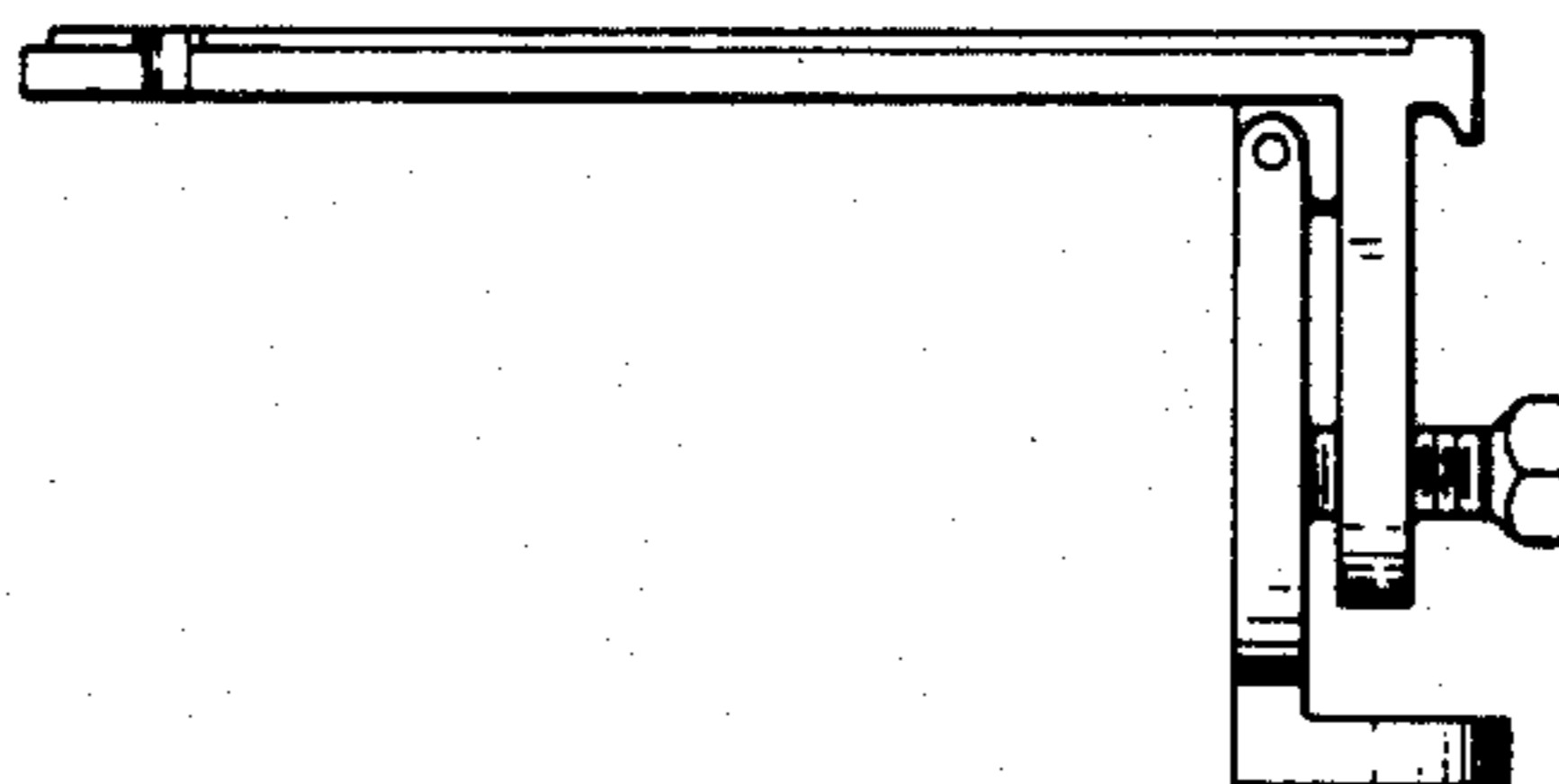
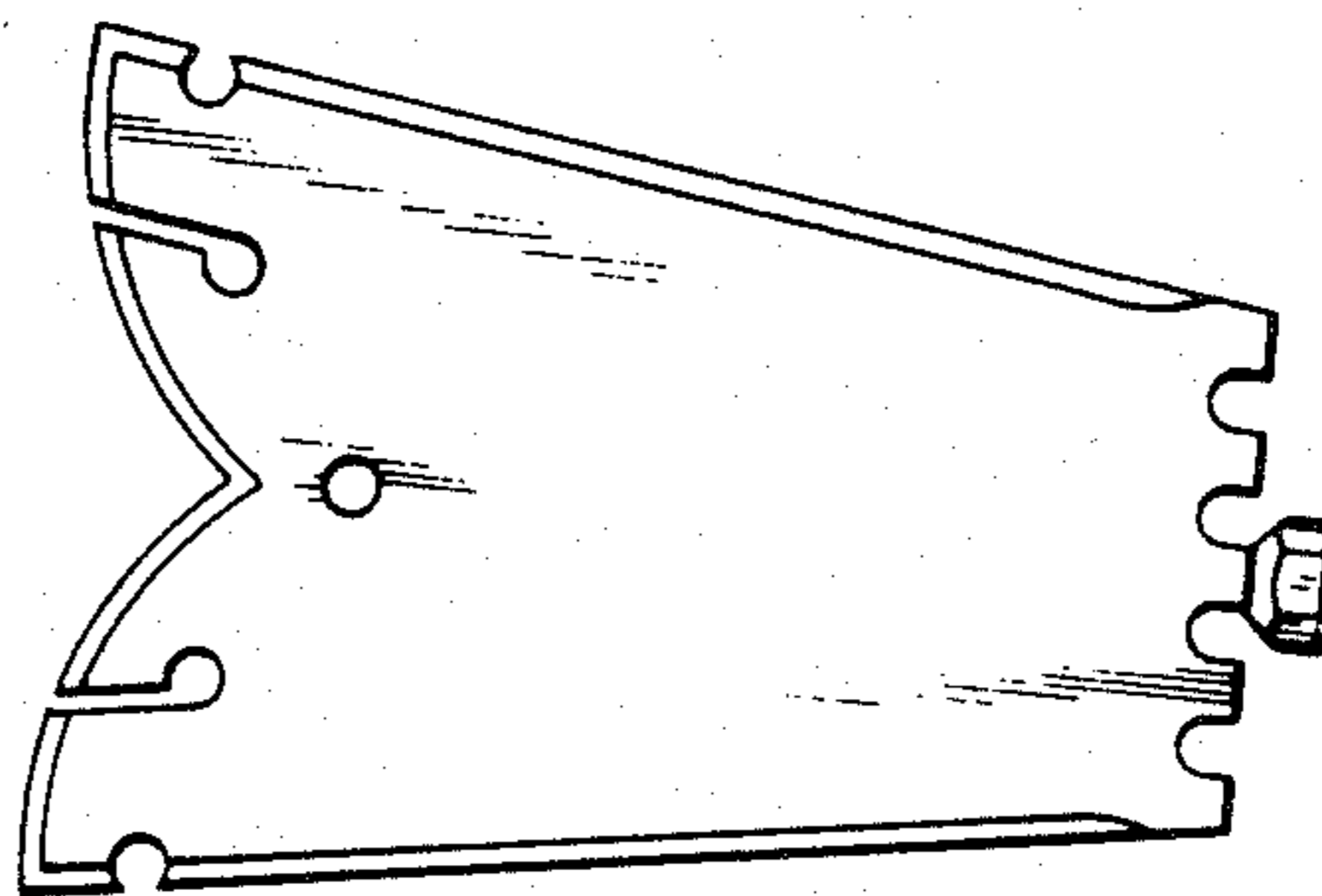

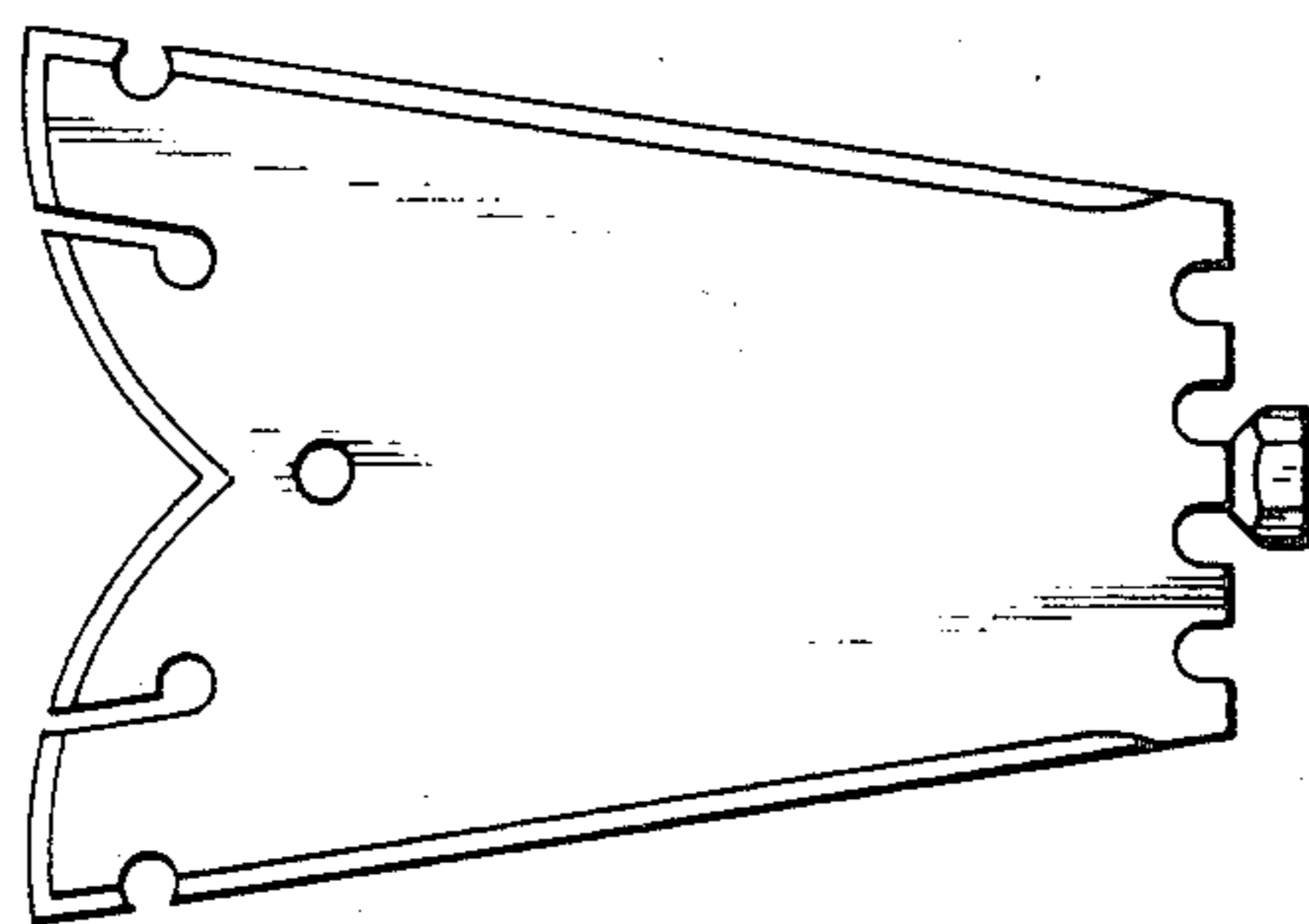

FIG. 1

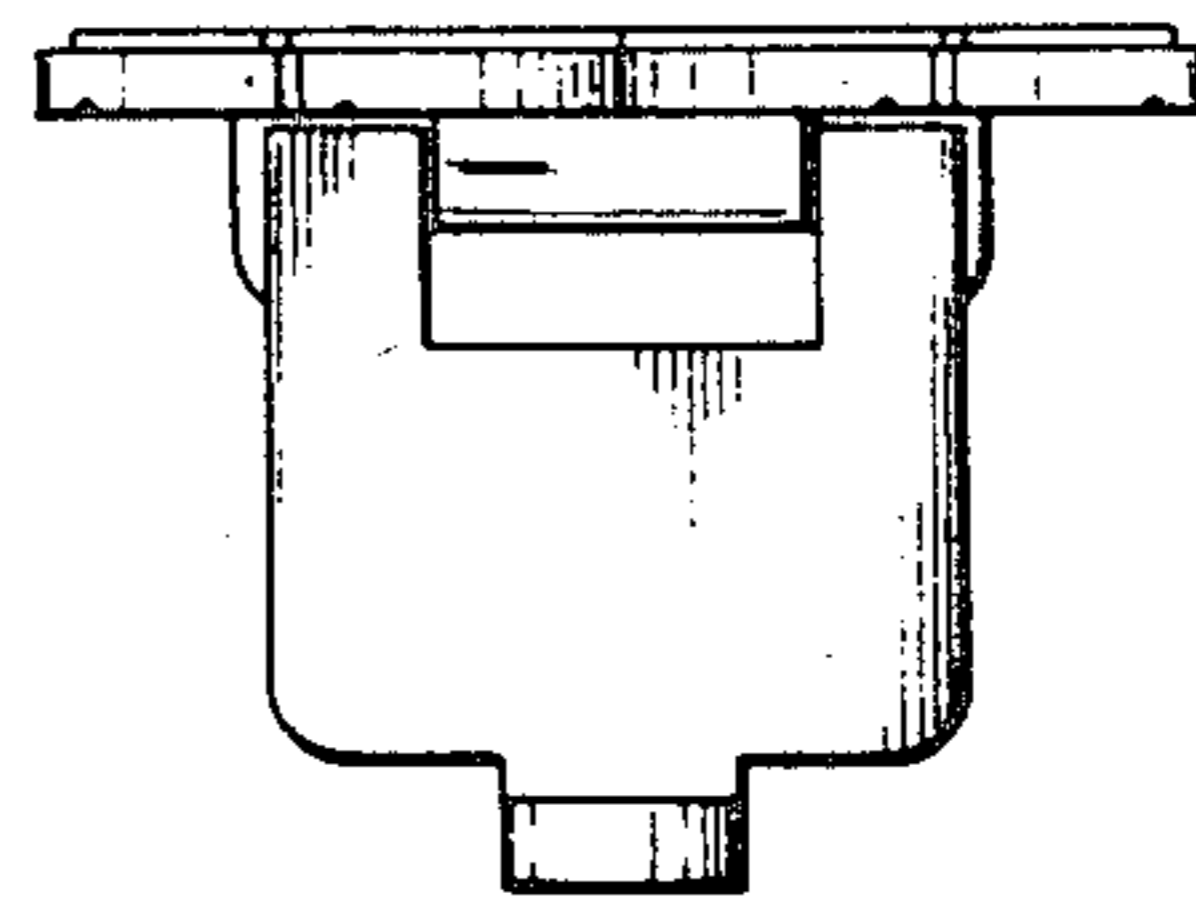

FIG. 2

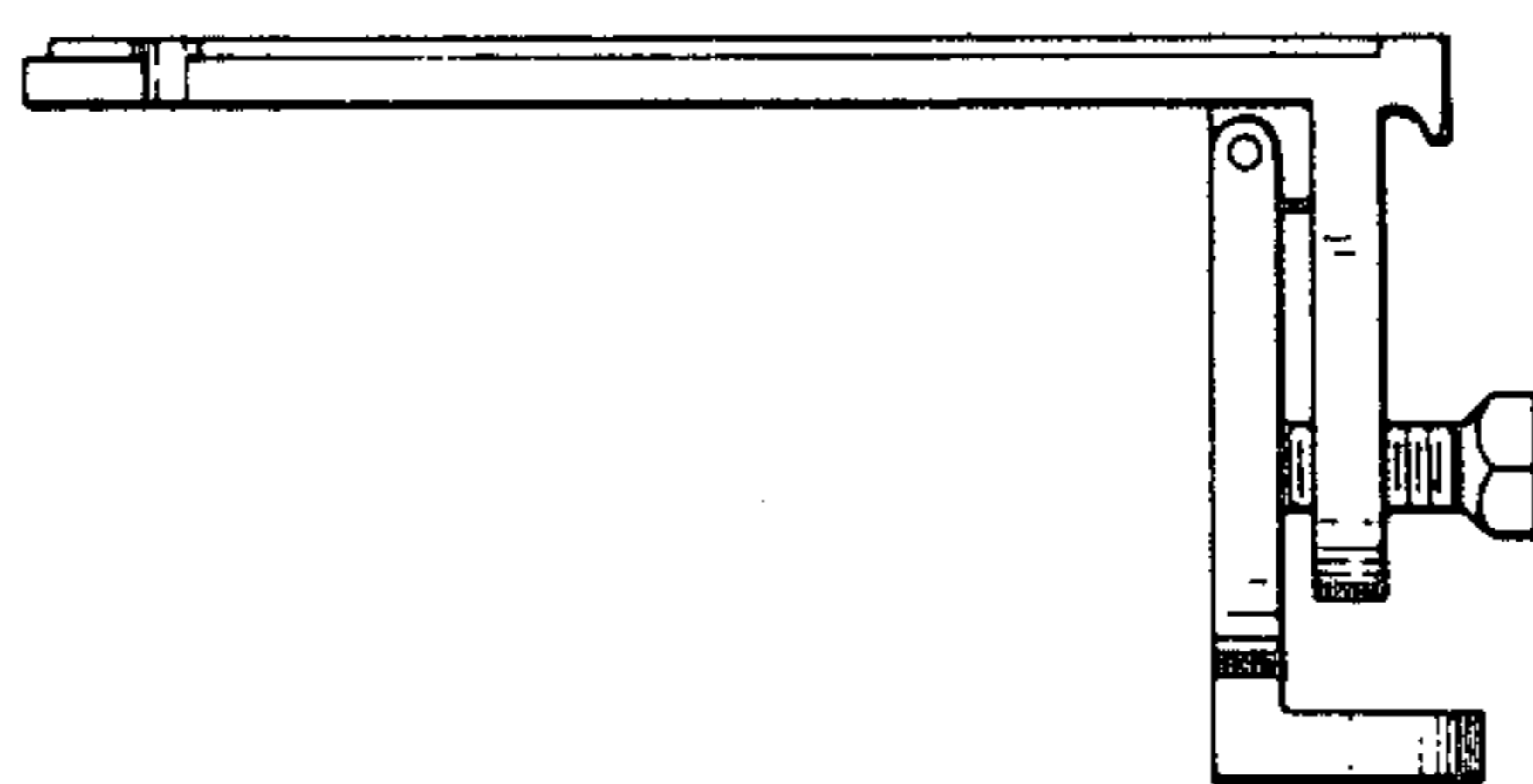

FIG. 3

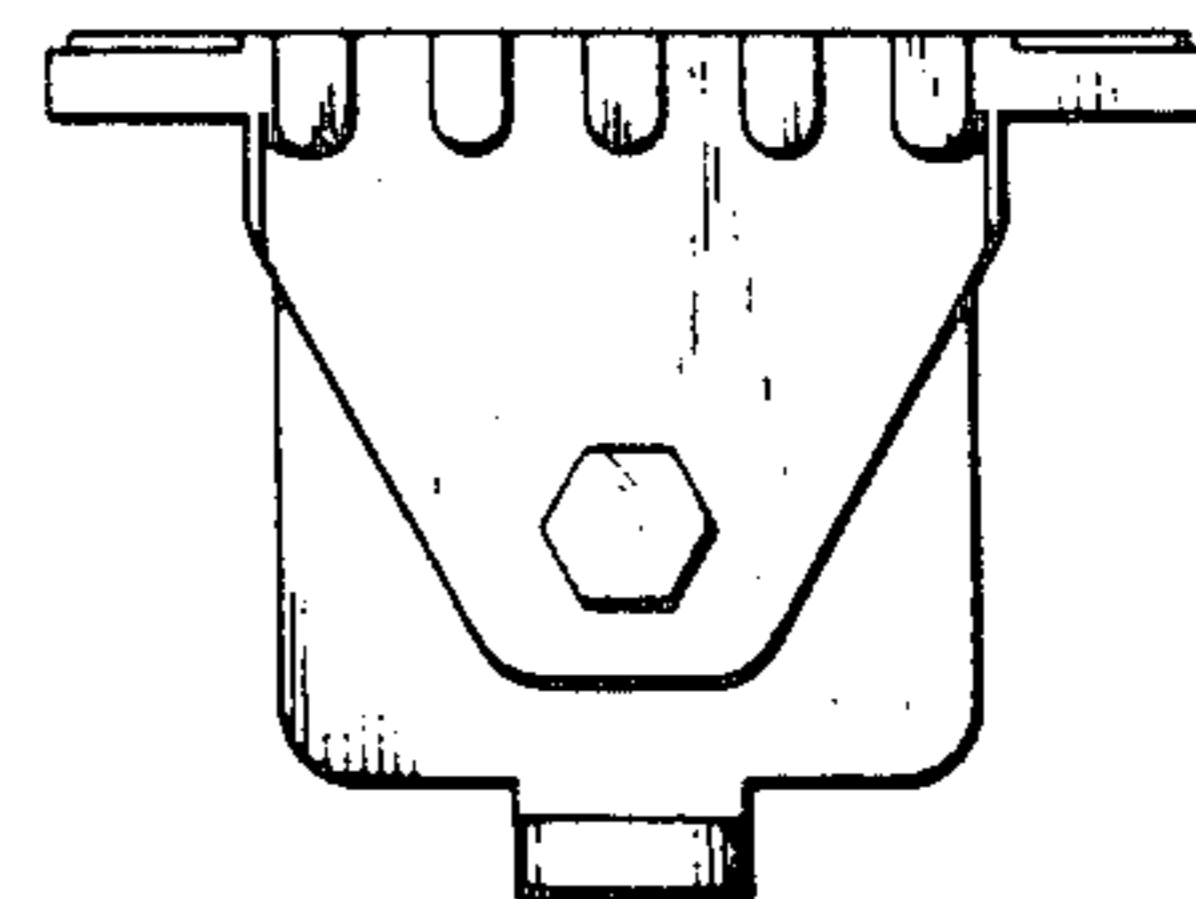

FIG. 4

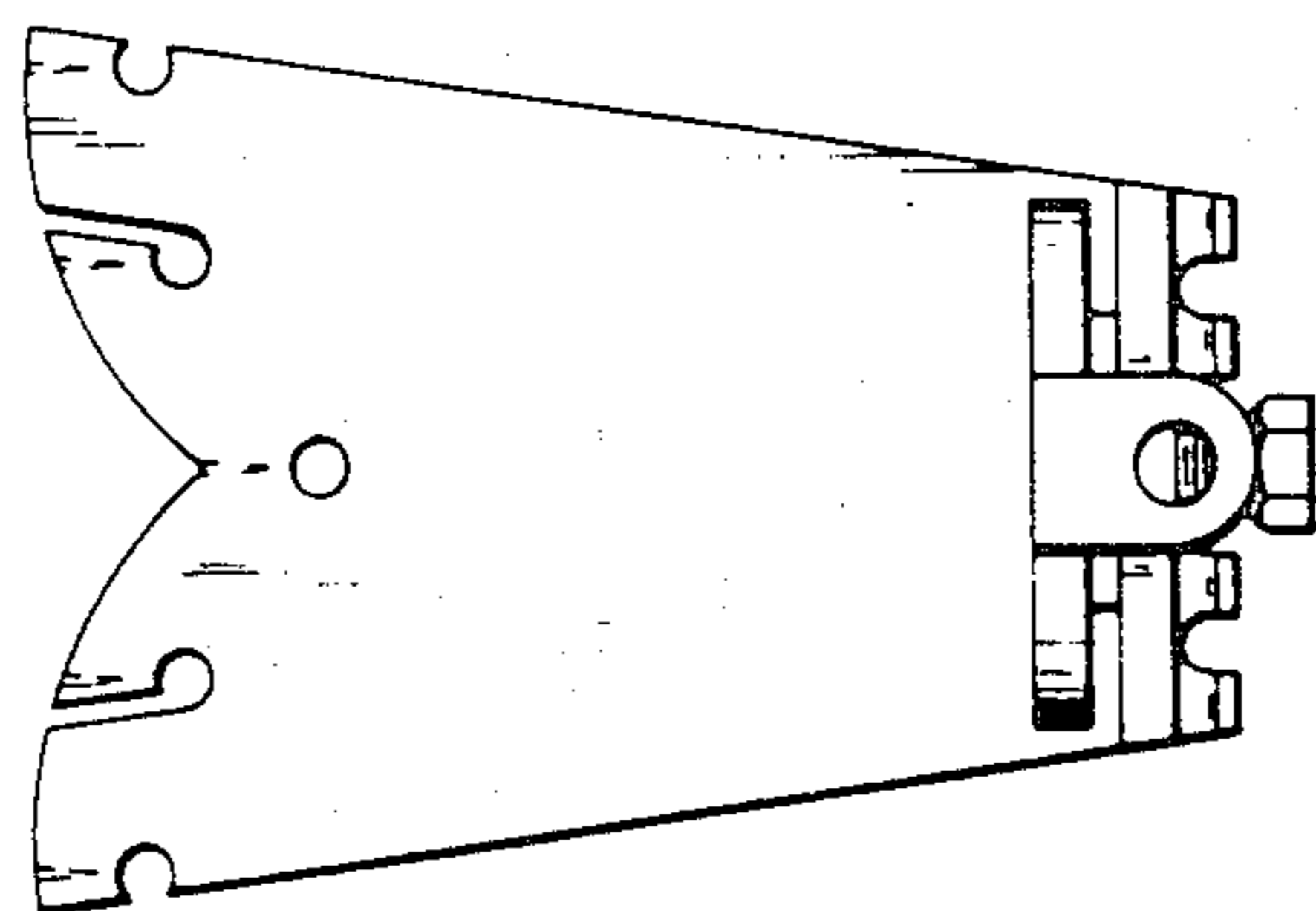

FIG. 5