

[54] **VANITY CASE**

0202004 8/1923 United Kingdom ..... 220/1 R

[76] **Inventor: Bruce R. Thompson, 32 Shakespeare Ave., Tranmere, South Australia, Australia**

[\*\*] **Term: 14 Years**

[21] **Appl. No.: 438,328**

[22] **Filed: Nov. 1, 1982**

[30] **Foreign Application Priority Data**

May 5, 1982 [AU] Australia ..... 303/82

[52] **U.S. Cl. .... D3/39**

[58] **Field of Search ..... D3/30.1, 39; 206/77.1; 220/1 R, 4 B**

[56] **References Cited**

**U.S. PATENT DOCUMENTS**

1,436,406 11/1922 Schulz ..... 220/1 R  
3,412,888 11/1968 Andrews et al. .... 220/4 B  
4,220,134 9/1980 Snyder ..... 220/4 B

**FOREIGN PATENT DOCUMENTS**

1424579 12/1965 France ..... 206/77.1

**OTHER PUBLICATIONS**

Abitare, Gedy, v. 197, 9/81, p. 139, Container #1 in lower left corner.

*Primary Examiner*—A. Hugo Word

*Assistant Examiner*—Suzanne N. Gitlin

*Attorney, Agent, or Firm*—McDougall, Hersh & Scott

[57] **CLAIM**

The ornamental design for a vanity case, as shown.

**DESCRIPTION**

FIG. 1 is a perspective view of a vanity case showing my new design;

FIG. 2 is an exploded perspective view thereof;

FIG. 3 is a front elevational view thereof;

FIG. 4 is a rear elevational view thereof;

FIG. 5 is an end elevational view taken from the right of FIG. 1;

FIG. 6 is an end elevational view taken from the left of FIG. 1;

FIG. 7 is a top plan view thereof; and

FIG. 8 is a bottom plan view thereof.

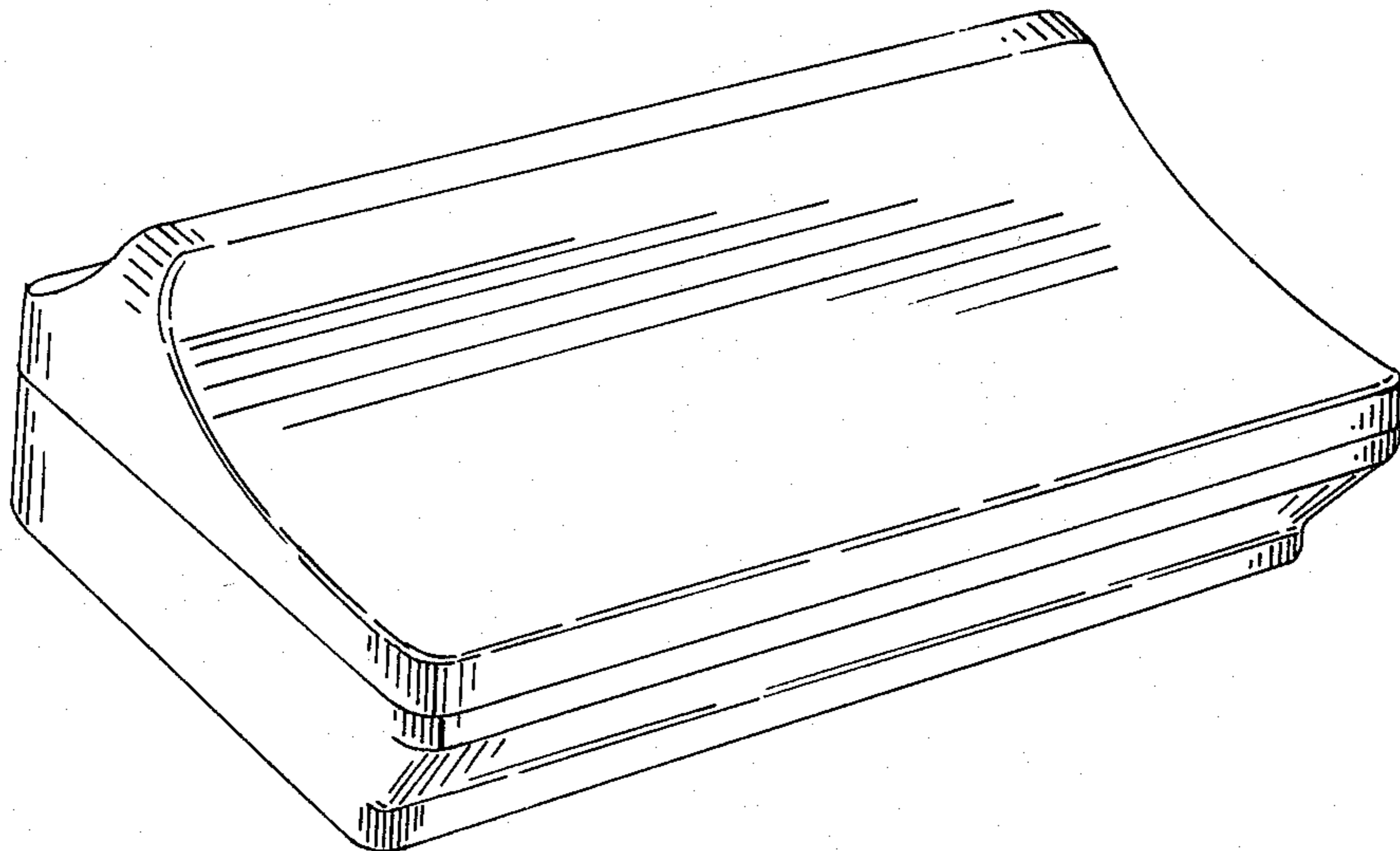

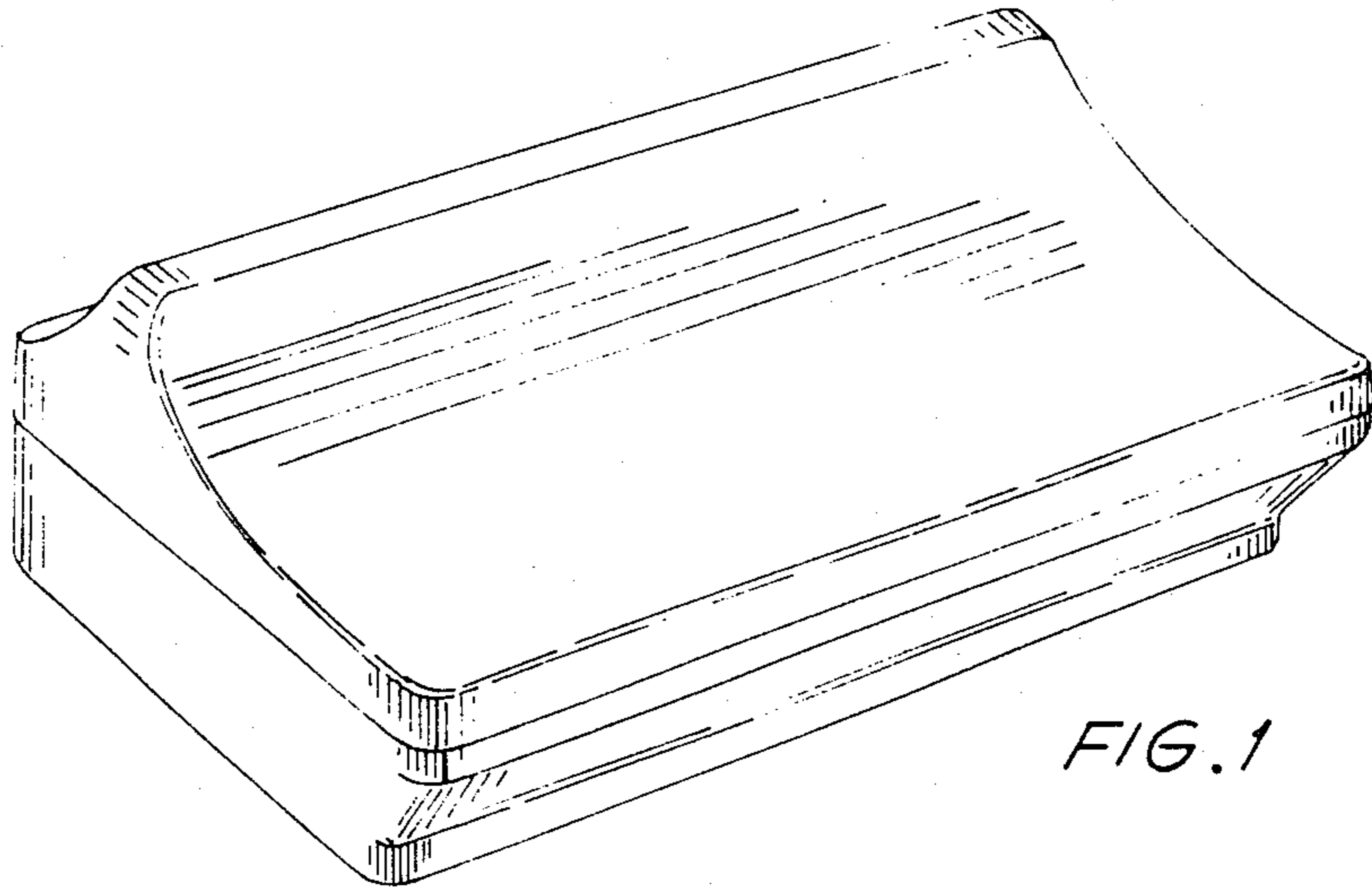

FIG. 1

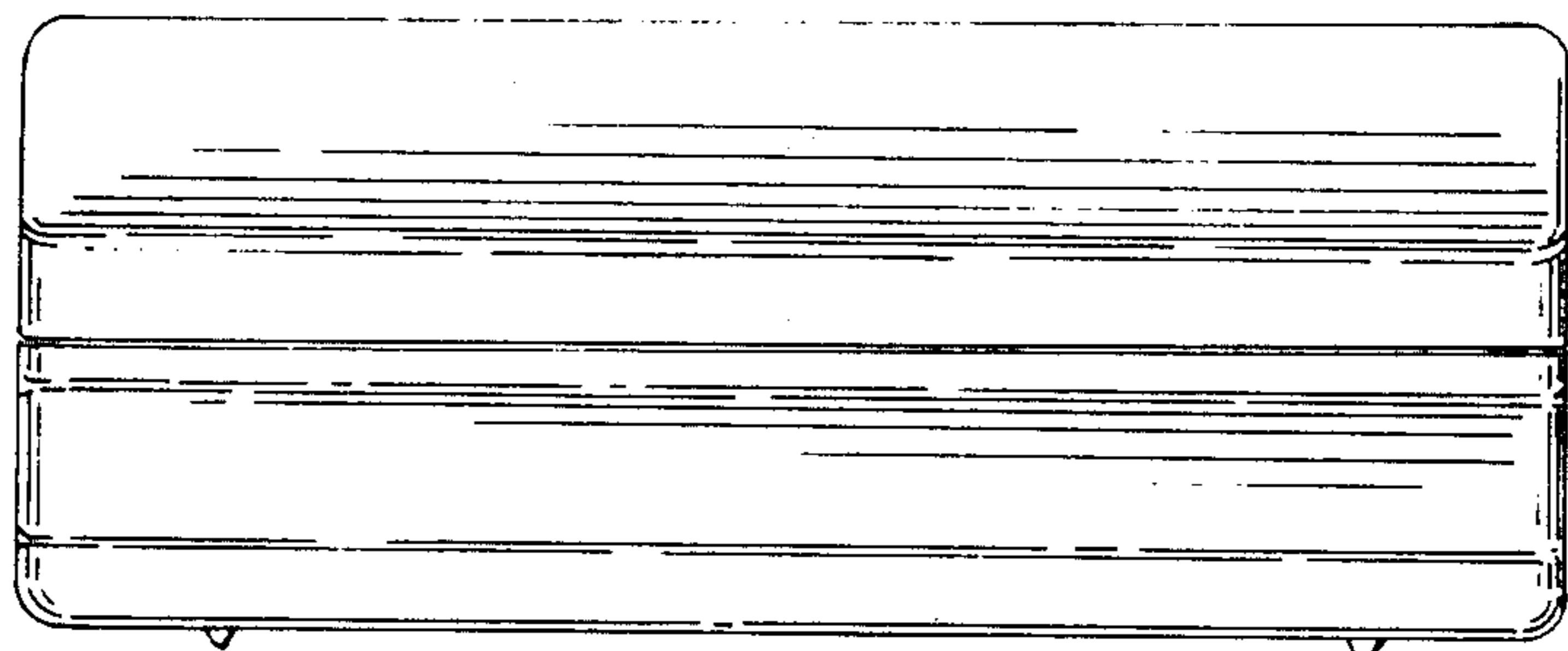

FIG. 3

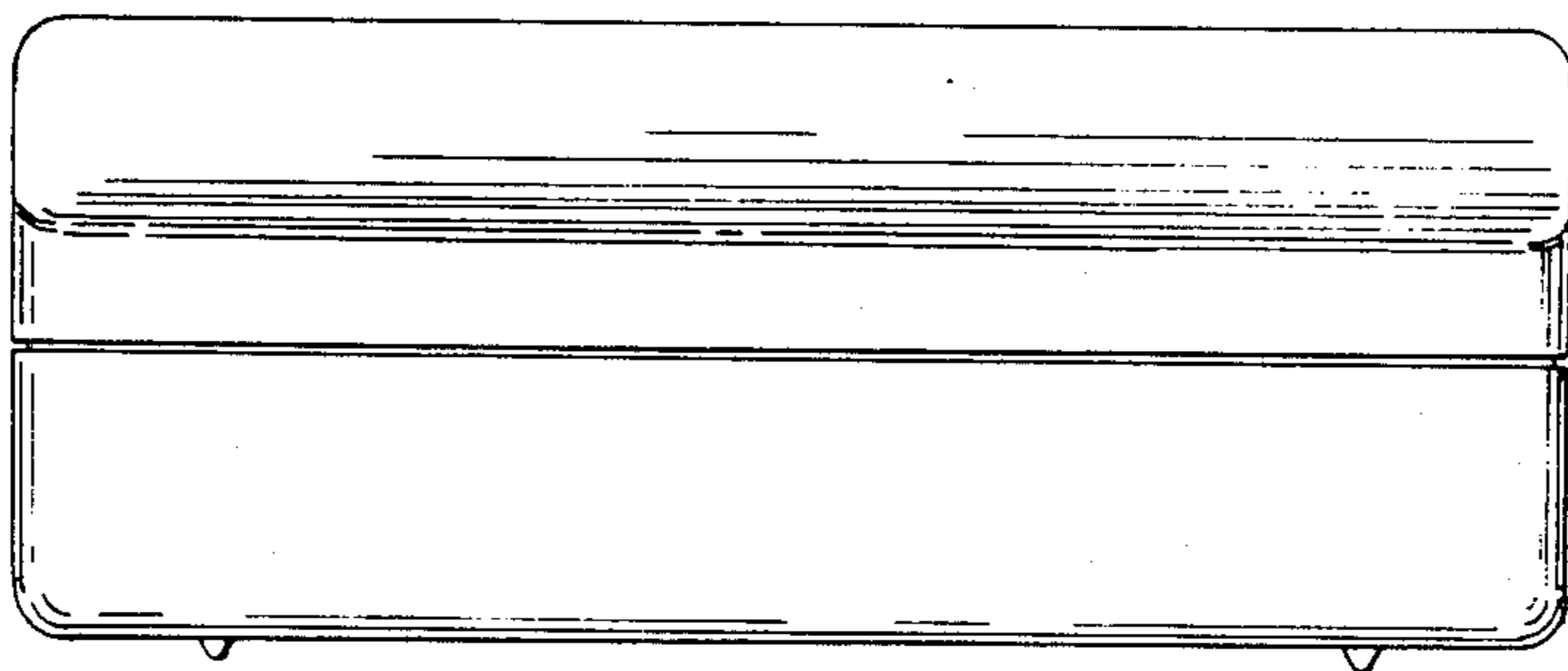
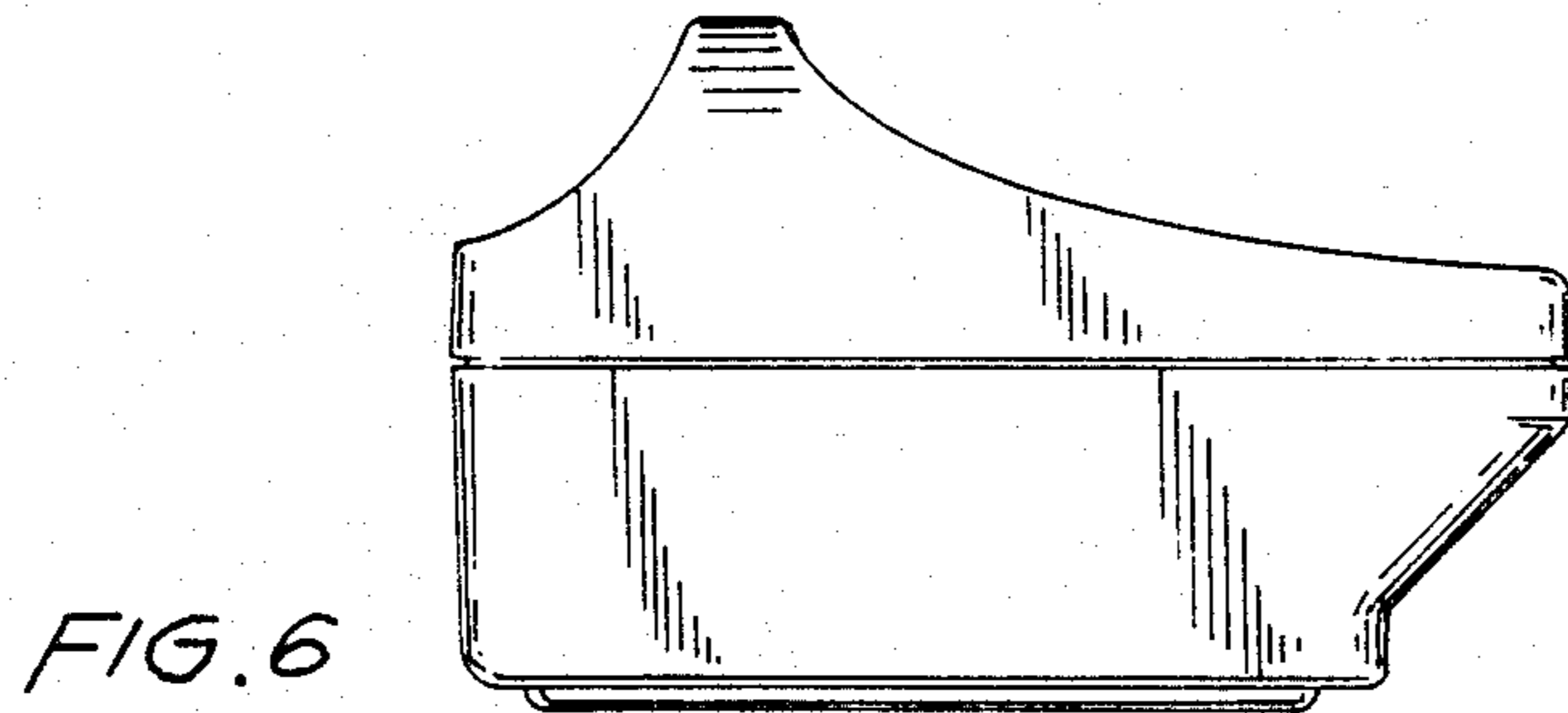
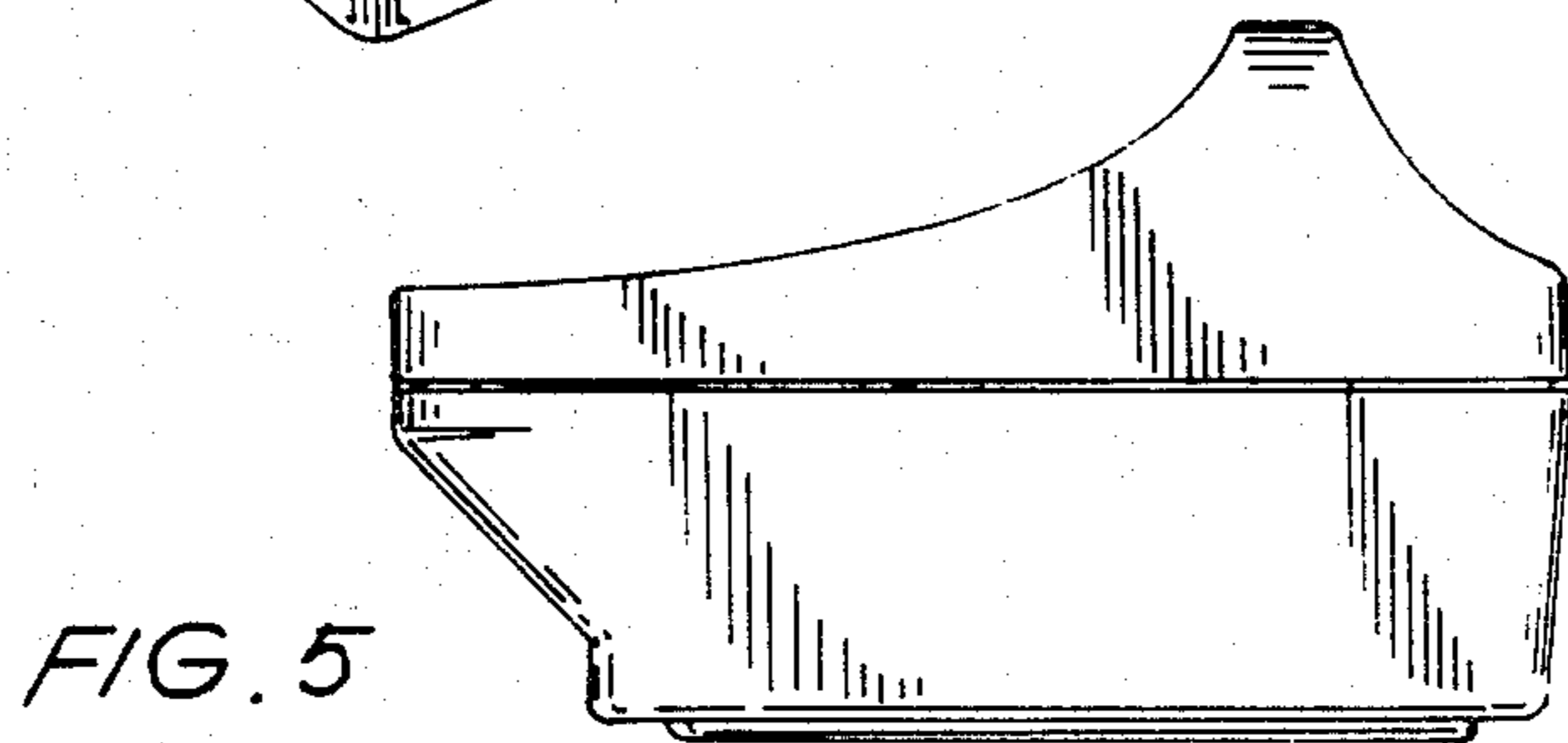
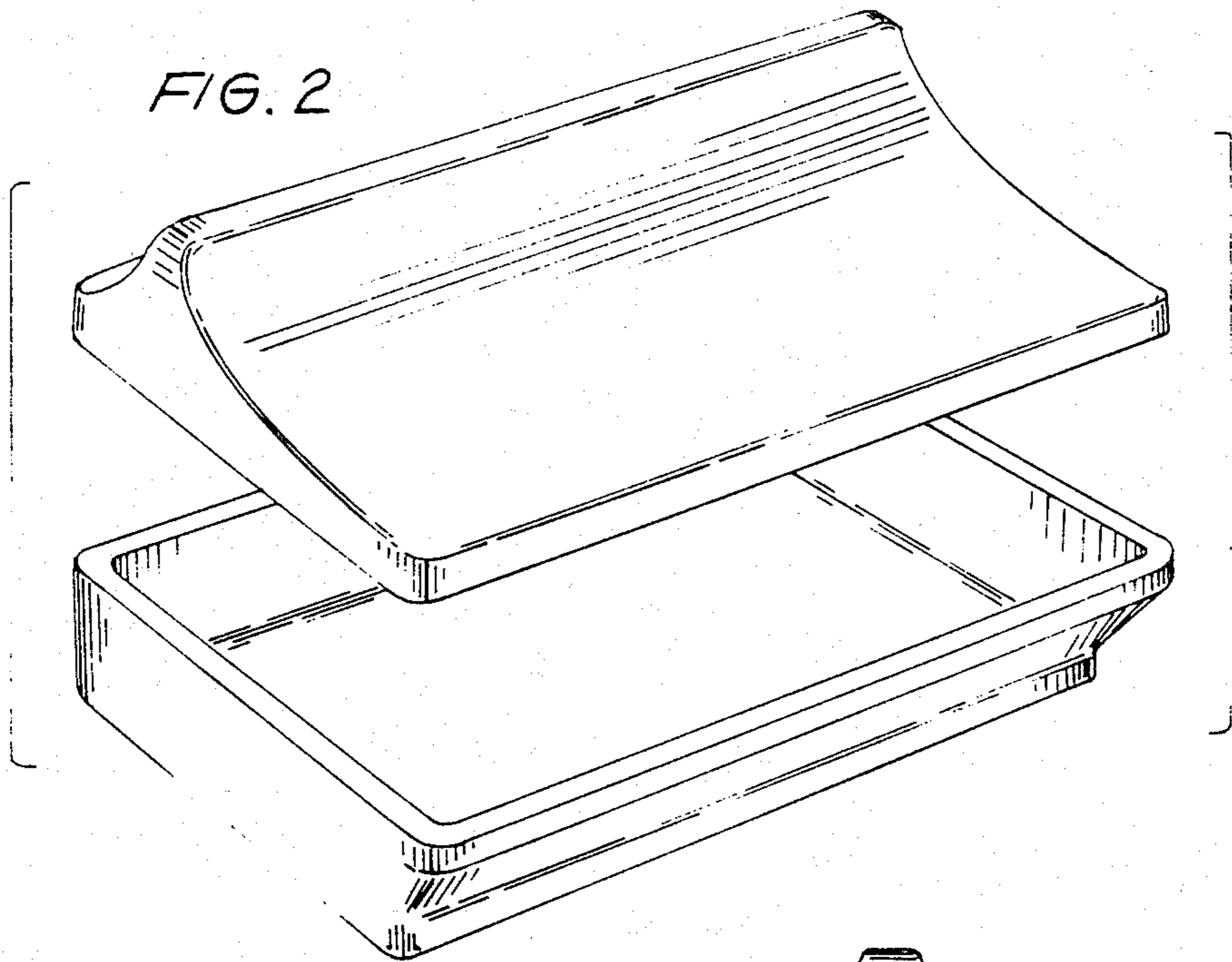

FIG. 4



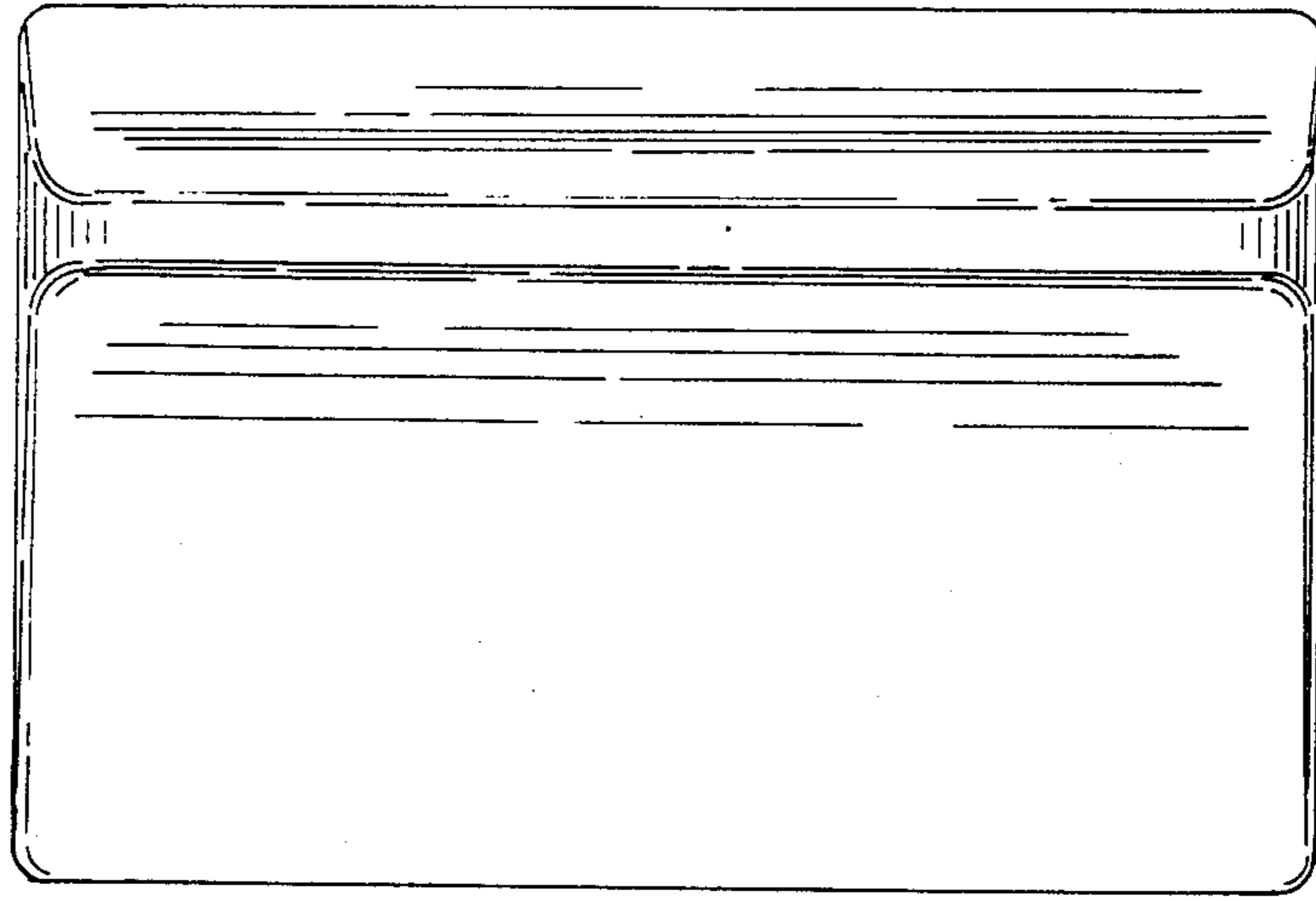

FIG. 7

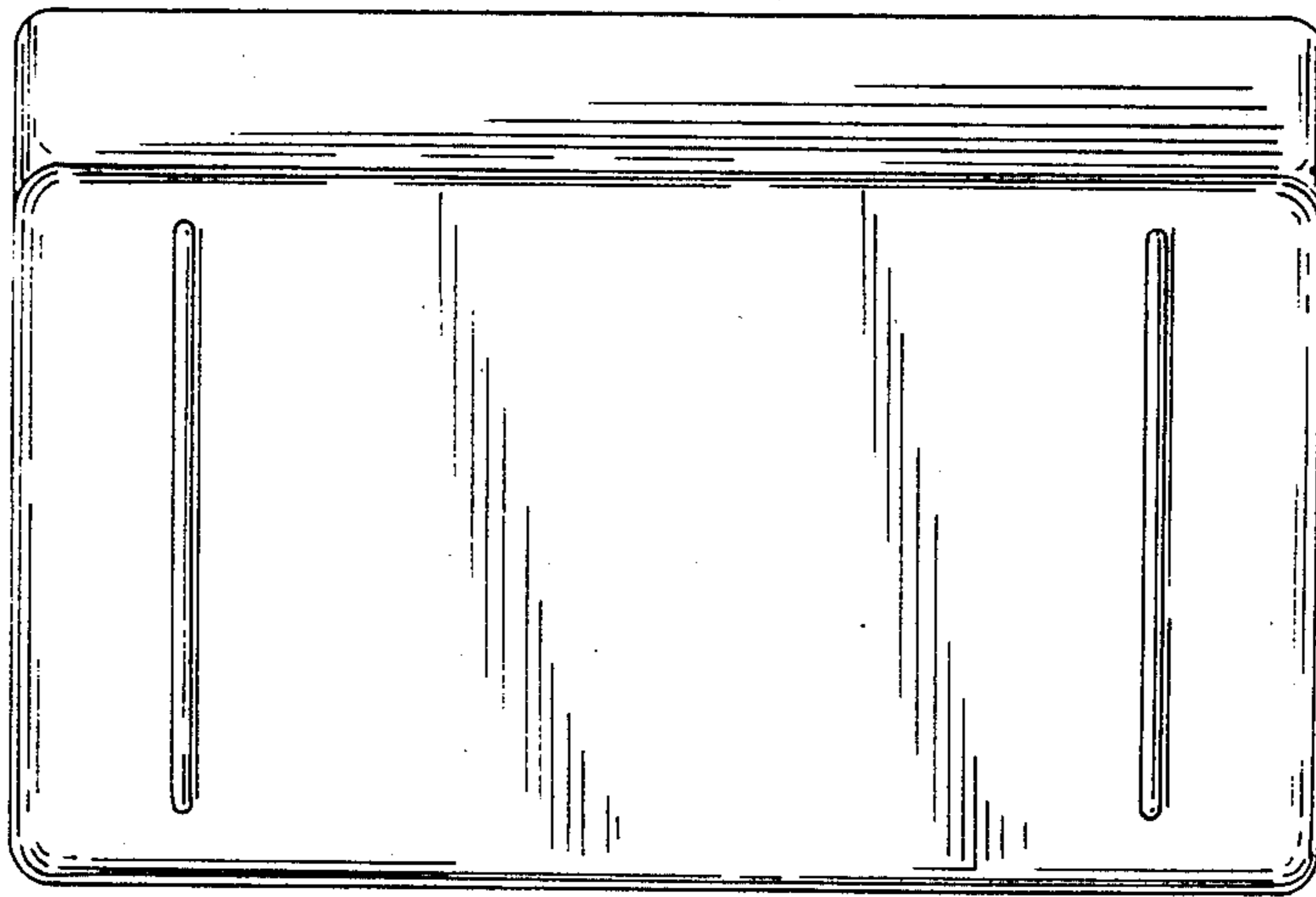

FIG. 8