

United States Patent [19]

Chabot

[11] Patent Number: **Des. 277,797**

[45] Date of Patent: **** Feb. 26, 1985**

[54] TOTE BOX

[75] Inventor: **Jean-Marie Chabot, St-Damien, Canada**

[73] Assignee: **Les Industries Provinciales Ltée., St-Damien Bellechasse, Canada**

[**] Term: **14 Years**

[21] Appl. No.: **412,561**

[22] Filed: **Aug. 30, 1982**

[52] U.S. Cl. **D34/40; D9/425; D9/431; D9/432; D34/43**

[58] Field of Search **D34/40, 43, 45, 46; D7/37; D9/425, 430, 431, 432, 451; 220/23.83; 206/203, 503, 505, 509, 511, 557**

[56] **References Cited**

U.S. PATENT DOCUMENTS

D. 229,672	12/1973	Van Geem	D34/43
D. 246,872	1/1978	White	D34/43
D. 258,721	3/1981	Steeg	D34/43
D. 265,768	8/1982	Howley	D34/40

D. 271,153	10/1983	Deaton	D34/40
3,170,594	2/1965	Nascher	D34/40 X

Primary Examiner—Robert C. Spangler
Attorney, Agent, or Firm—Jean H. Dubuc

[57] CLAIM

The ornamental design for a tote box, as shown and described.

DESCRIPTION

FIG. 1 is a perspective top view of a tote box showing my new design;
FIG. 2 is a bottom perspective partial view showing one end thereof;
FIG. 3 is a bottom perspective partial view showing the other end thereof;
FIG. 4 is an elevation view showing the end seen in FIG. 3;
FIG. 5 is an elevation view showing the end seen in FIG. 2;
FIG. 6 is a side elevation view thereof;
FIG. 7 is a bottom view thereof; and
FIG. 8 is a top view thereof.

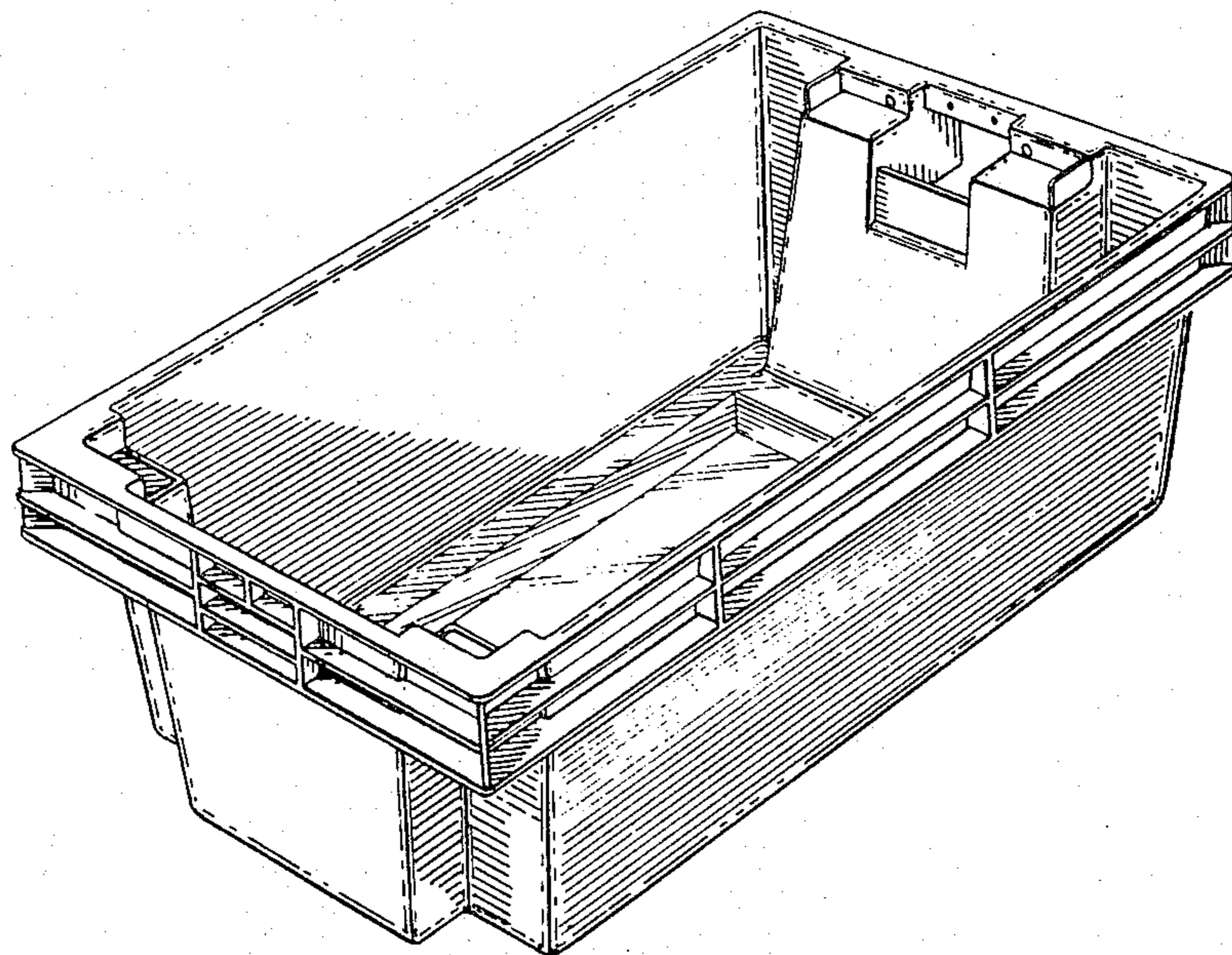

Fig. 1

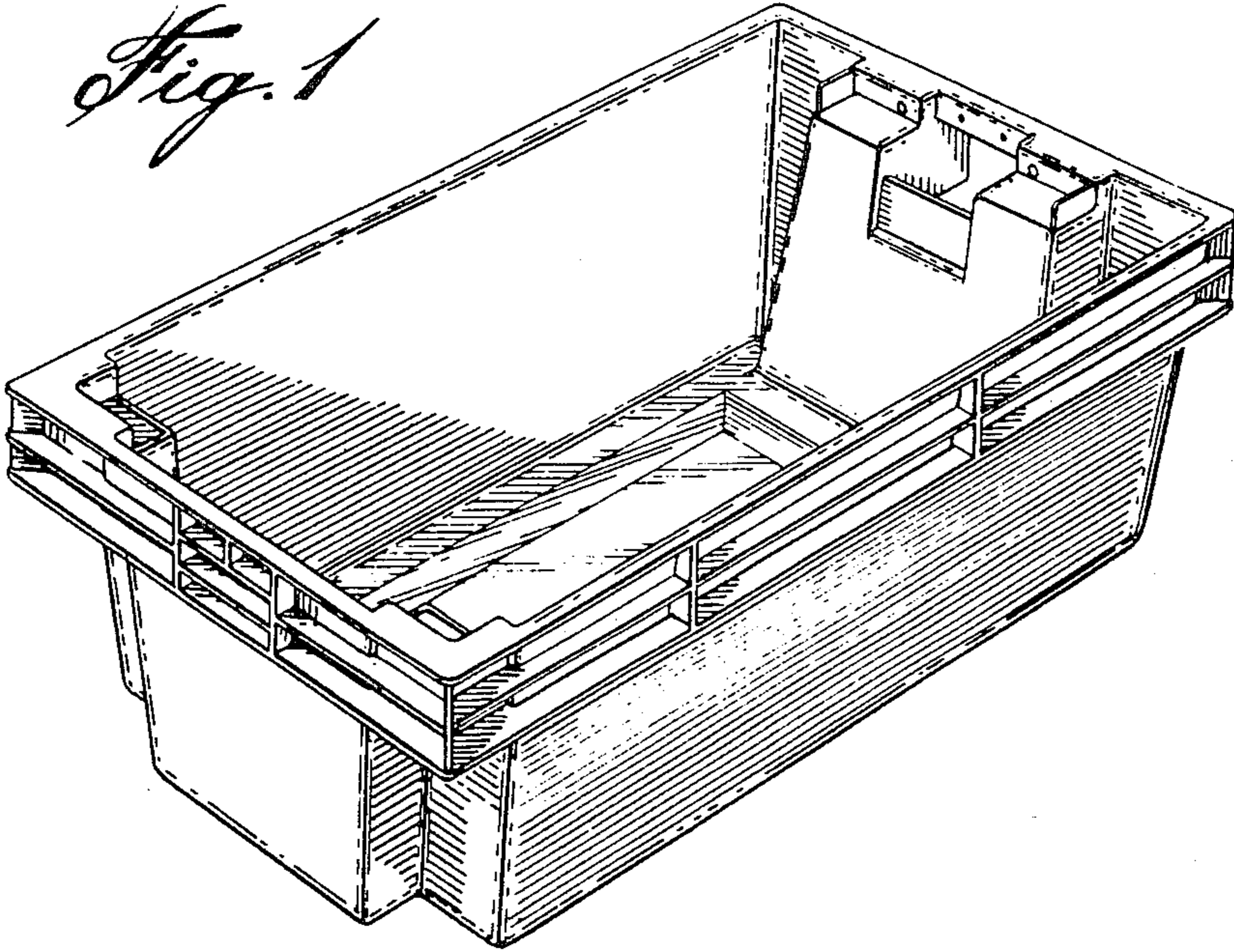

Fig. 2

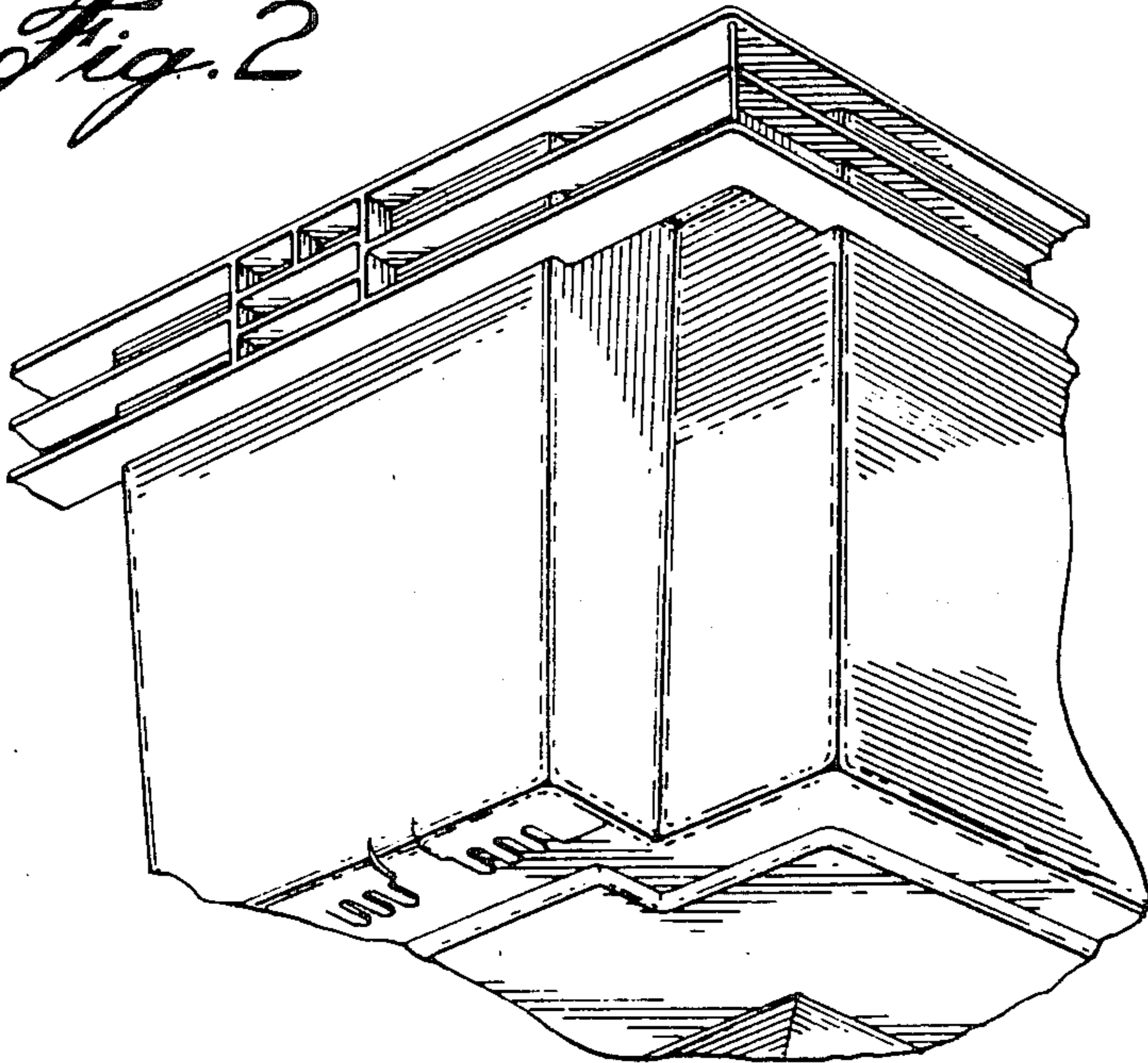

Fig. 3

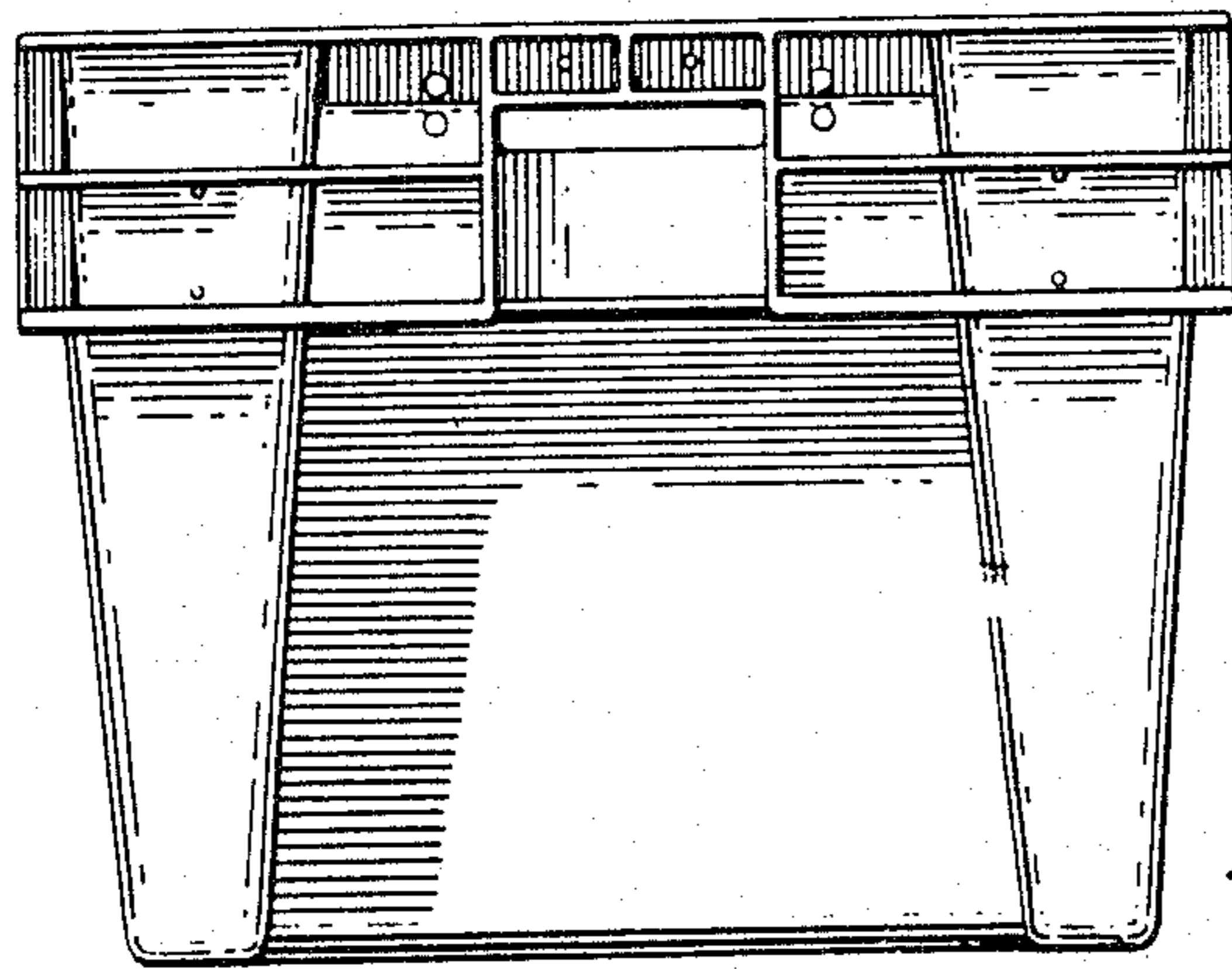
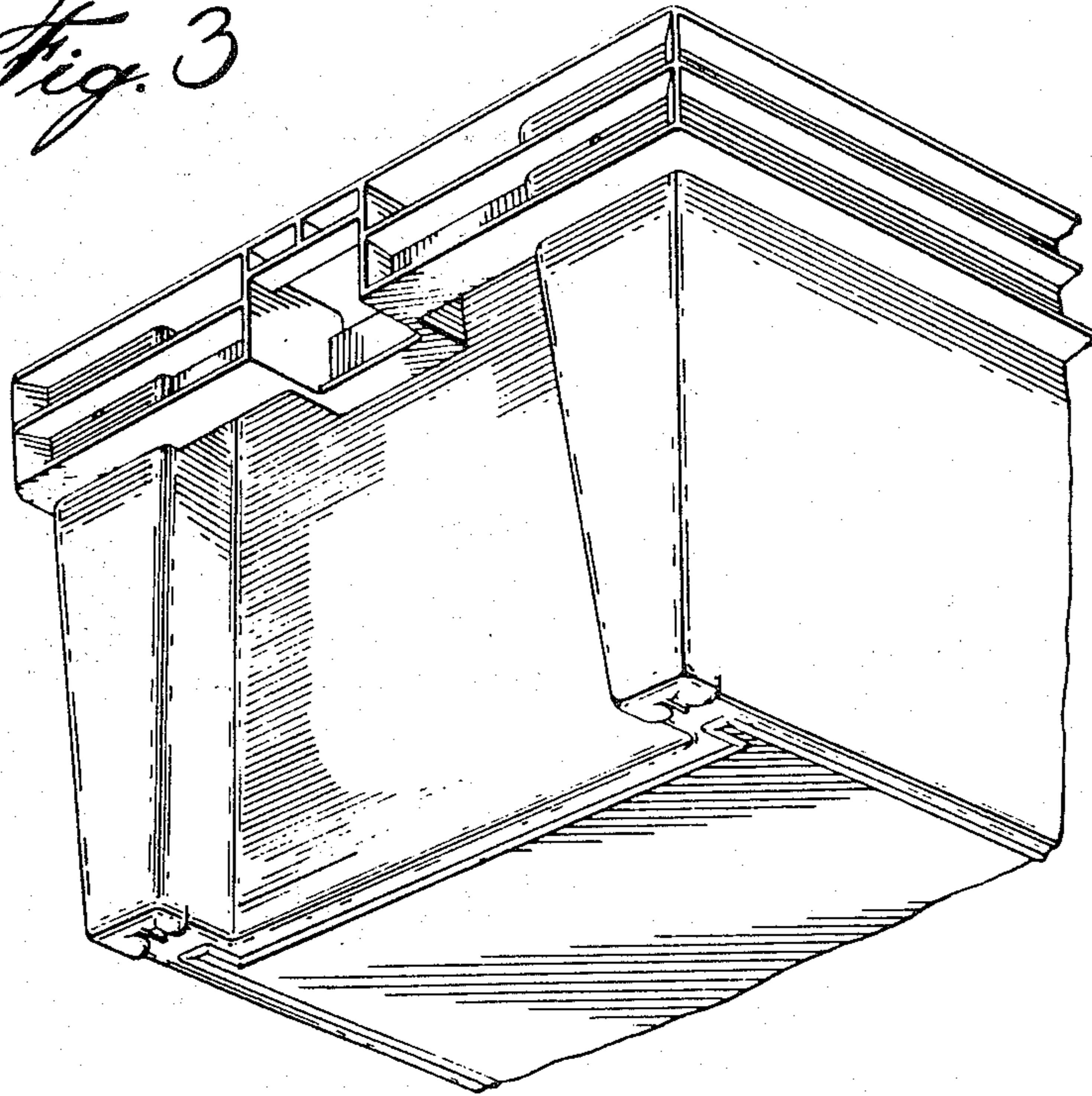

Fig. 4

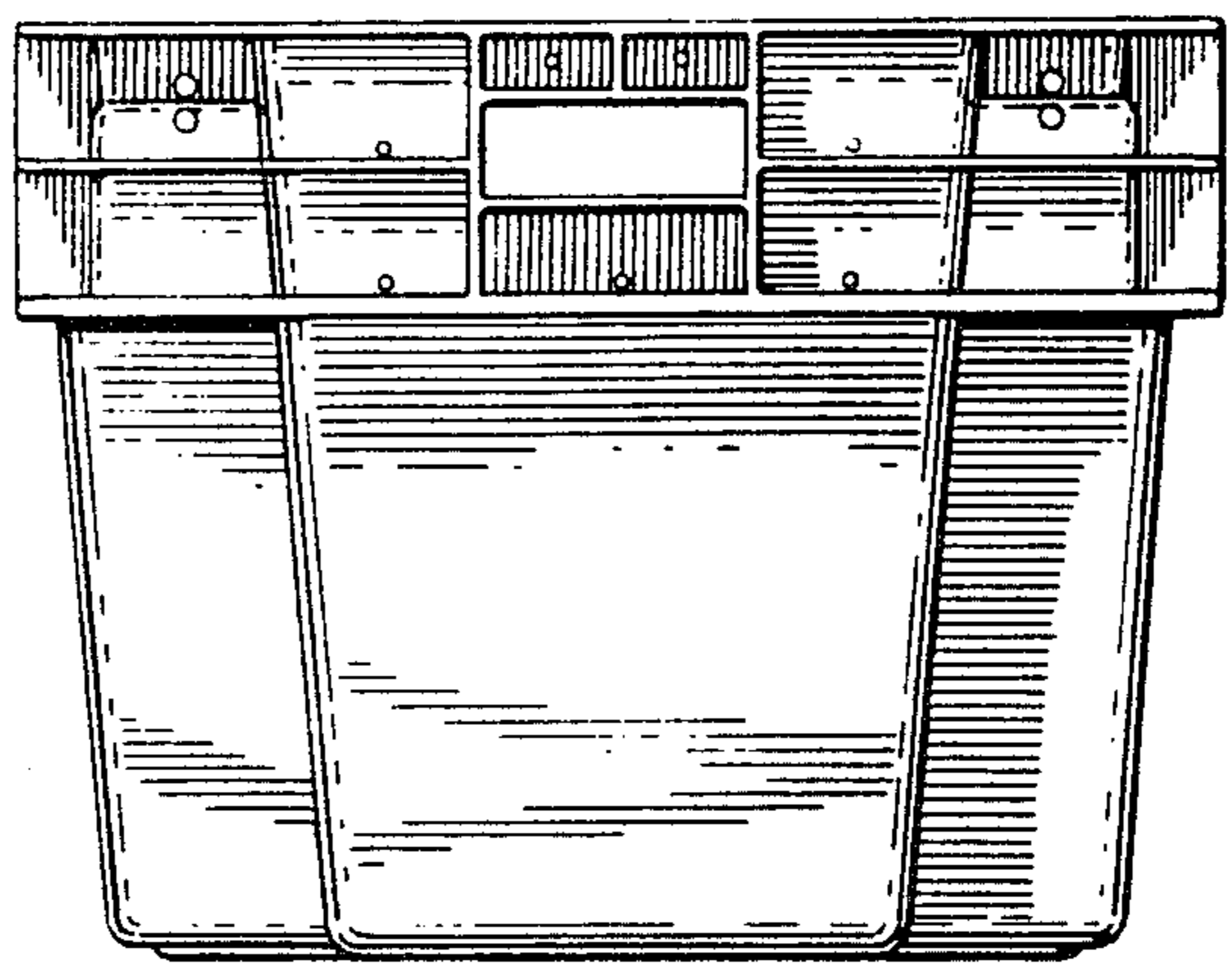

Fig. 5

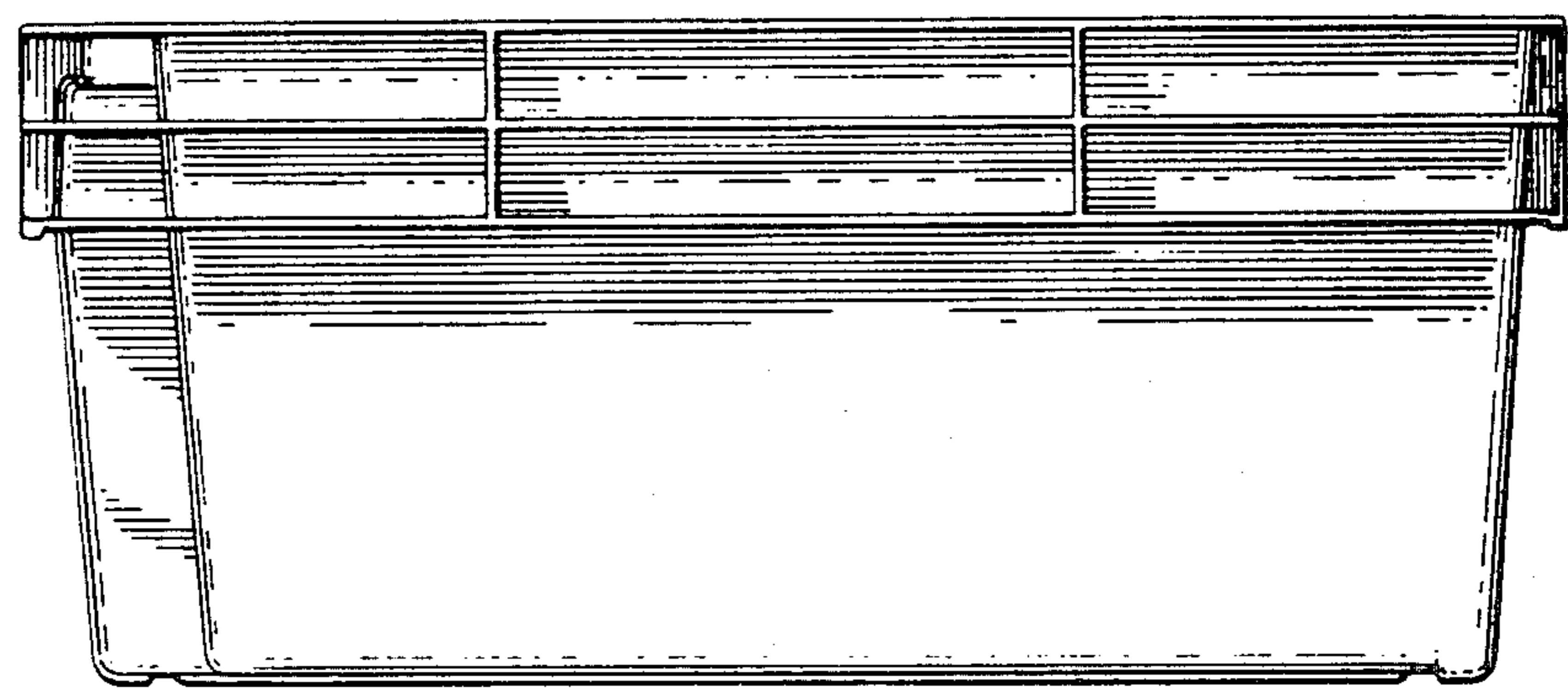

Fig. 6

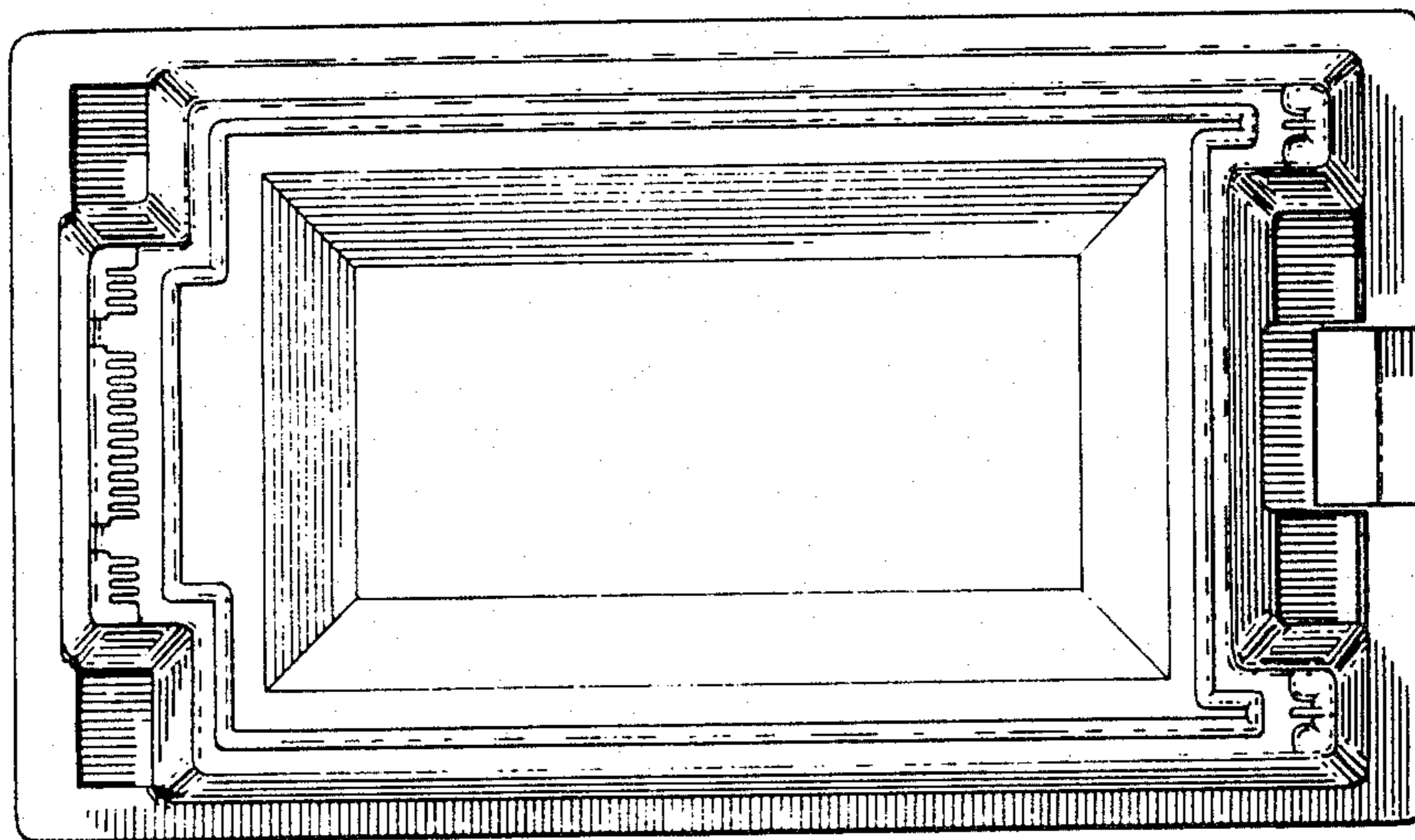

Fig. 7

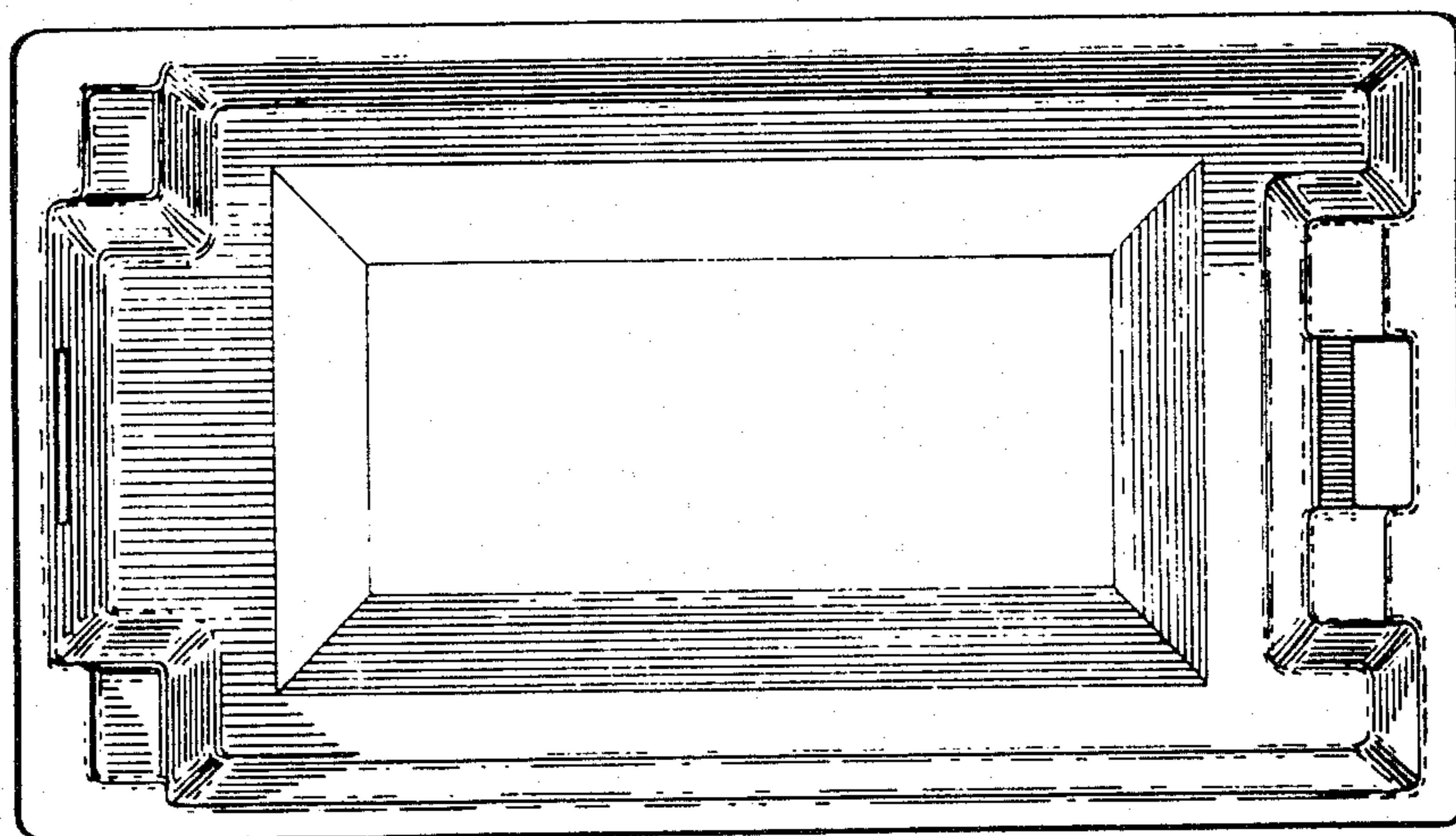

Fig. 8