

[54] LOUDSPEAKER

[75] Inventor: Hitoshi Nakamura, Tokyo, Japan

[73] Assignee: Pioneer Electronic Corporation, Tokyo, Japan

[**] Term: 14 Years

[21] Appl. No.: 444,914

[22] Filed: Nov. 29, 1982

[30] Foreign Application Priority Data

Jul. 2, 1982 [JP] Japan 57-29921

[52] U.S. Cl. D14/34; D14/30

[58] Field of Search D14/30, 32, 34, 37, D14/39; 179/179; 181/148

[56] References Cited

U.S. PATENT DOCUMENTS

- D. 269,871 7/1983 Ishizaki D14/34
- D. 269,872 7/1983 Ishizaki D14/34

OTHER PUBLICATIONS

"Pioneer Car Stereo Systems" Catalog CS180, ©'80, p. 36, Item #TS-X9.

High Fidelity, 10-81, p. 24, Kenwood KSC-701B Speakers.

Primary Examiner—Jane E. Corrigan
Attorney, Agent, or Firm—Sughrue, Mion, Zinn, Macpeak and Seas

[57] CLAIM

The ornamental design for a loudspeaker, as shown.

DESCRIPTION

FIG. 1 is a front elevational view of a loudspeaker showing my new design;

FIG. 2 is a left side elevational view thereof;

FIG. 3 is a right side elevational view thereof;

FIG. 4 is a bottom plan view thereof;

FIG. 5 is a top plan view thereof;

FIG. 6 is a rear elevational view thereof; and

FIG. 7 is a front and right side perspective view thereof.

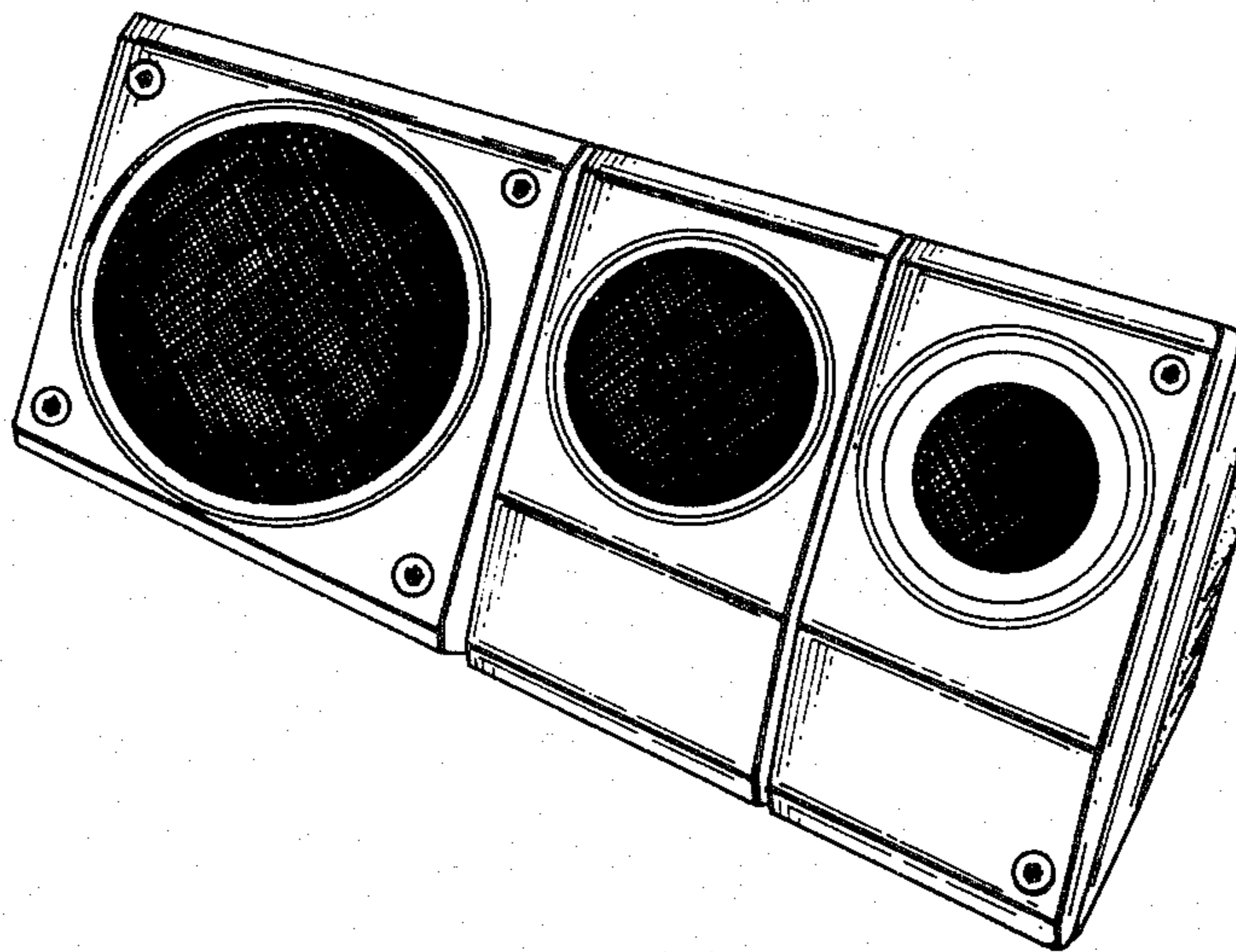

FIG. 1

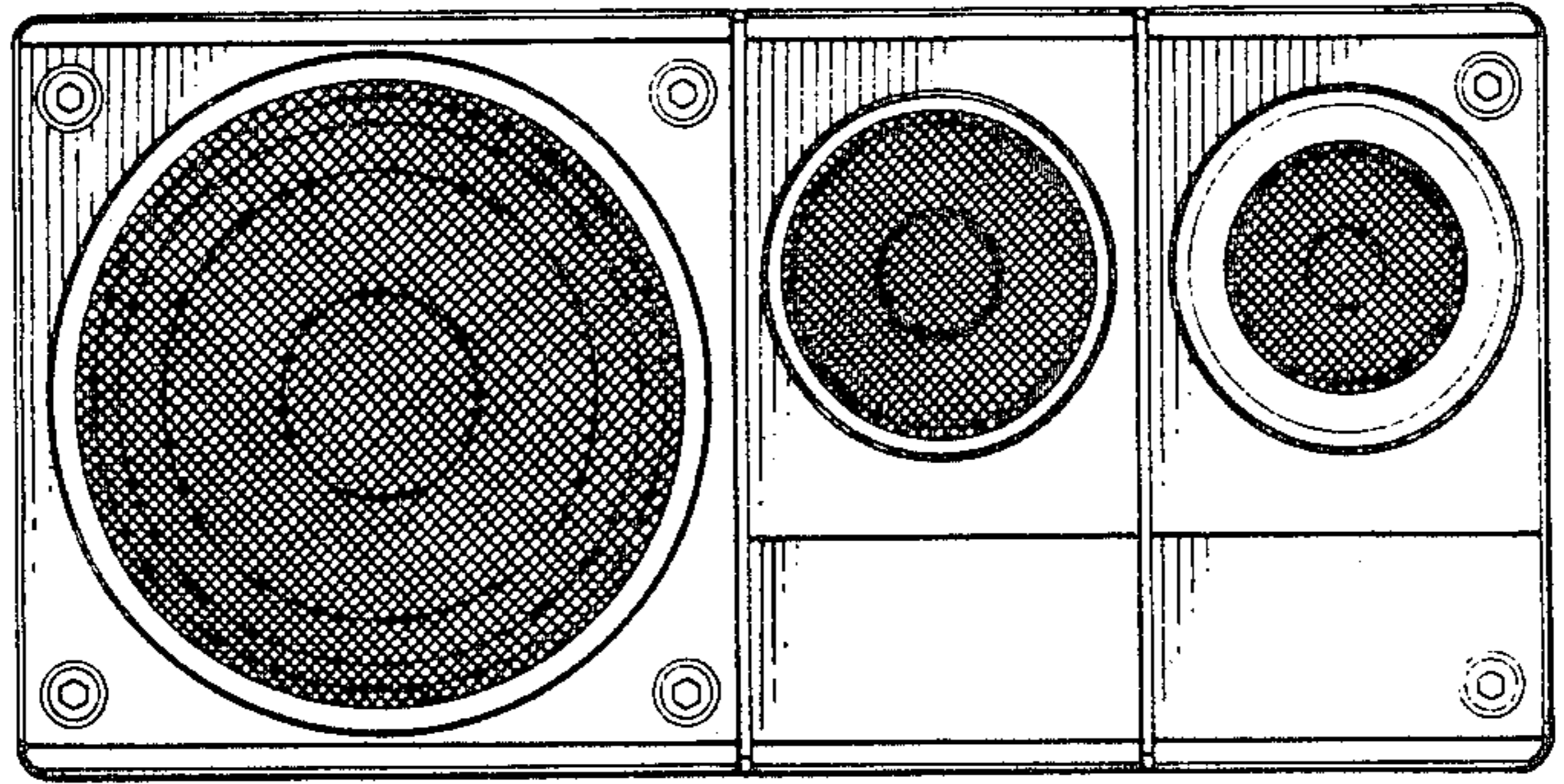

FIG. 2

FIG. 3

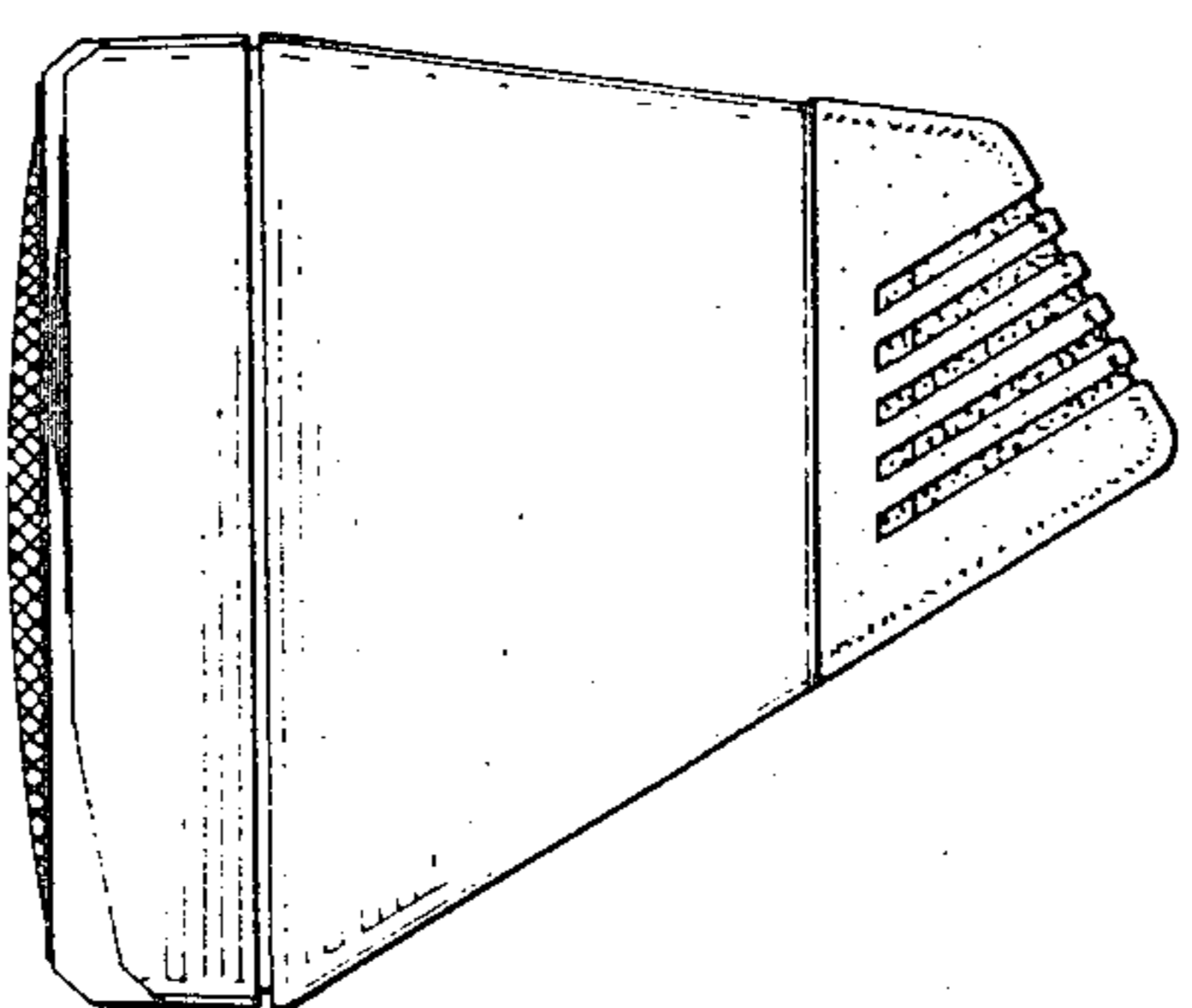
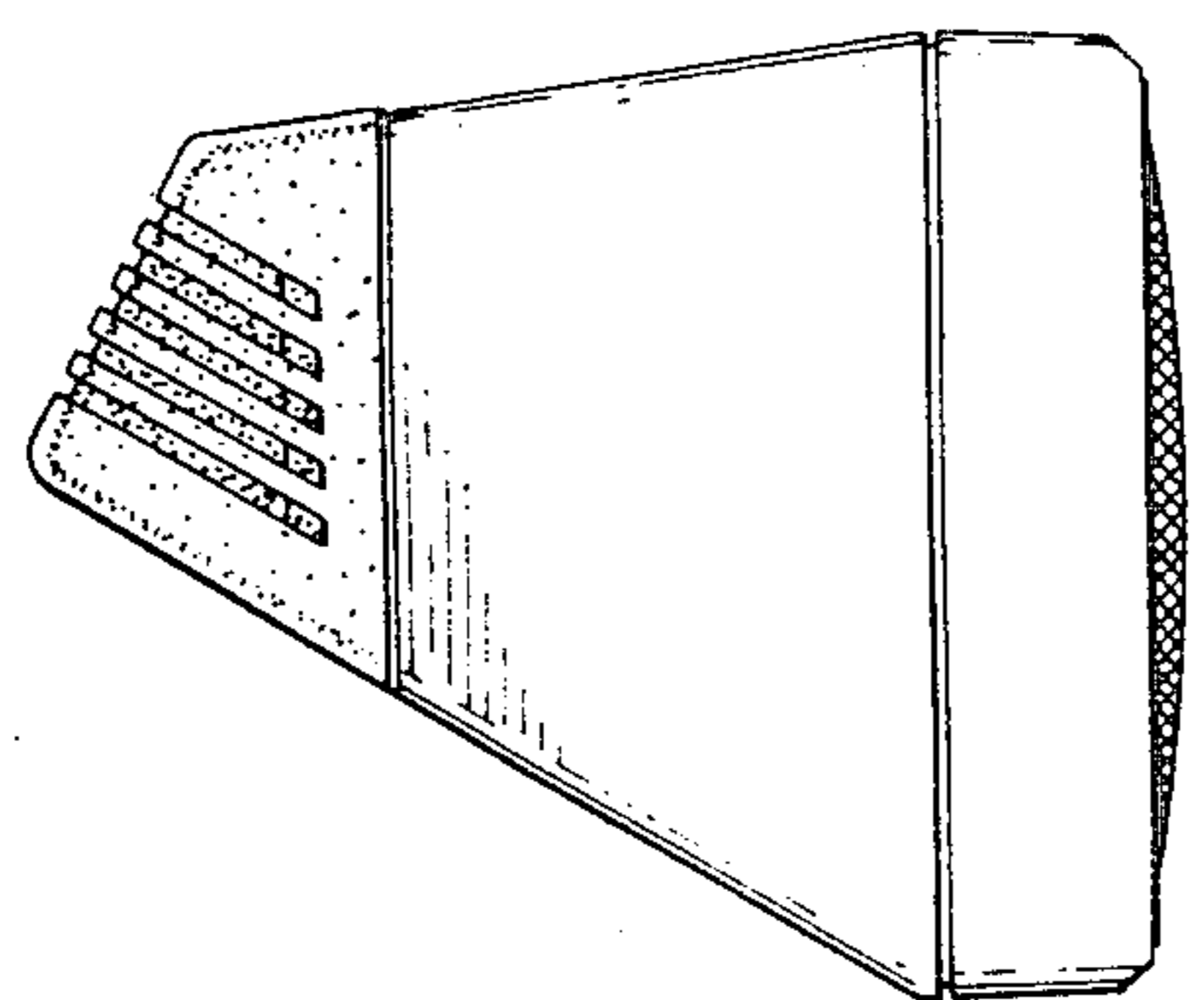

FIG. 4

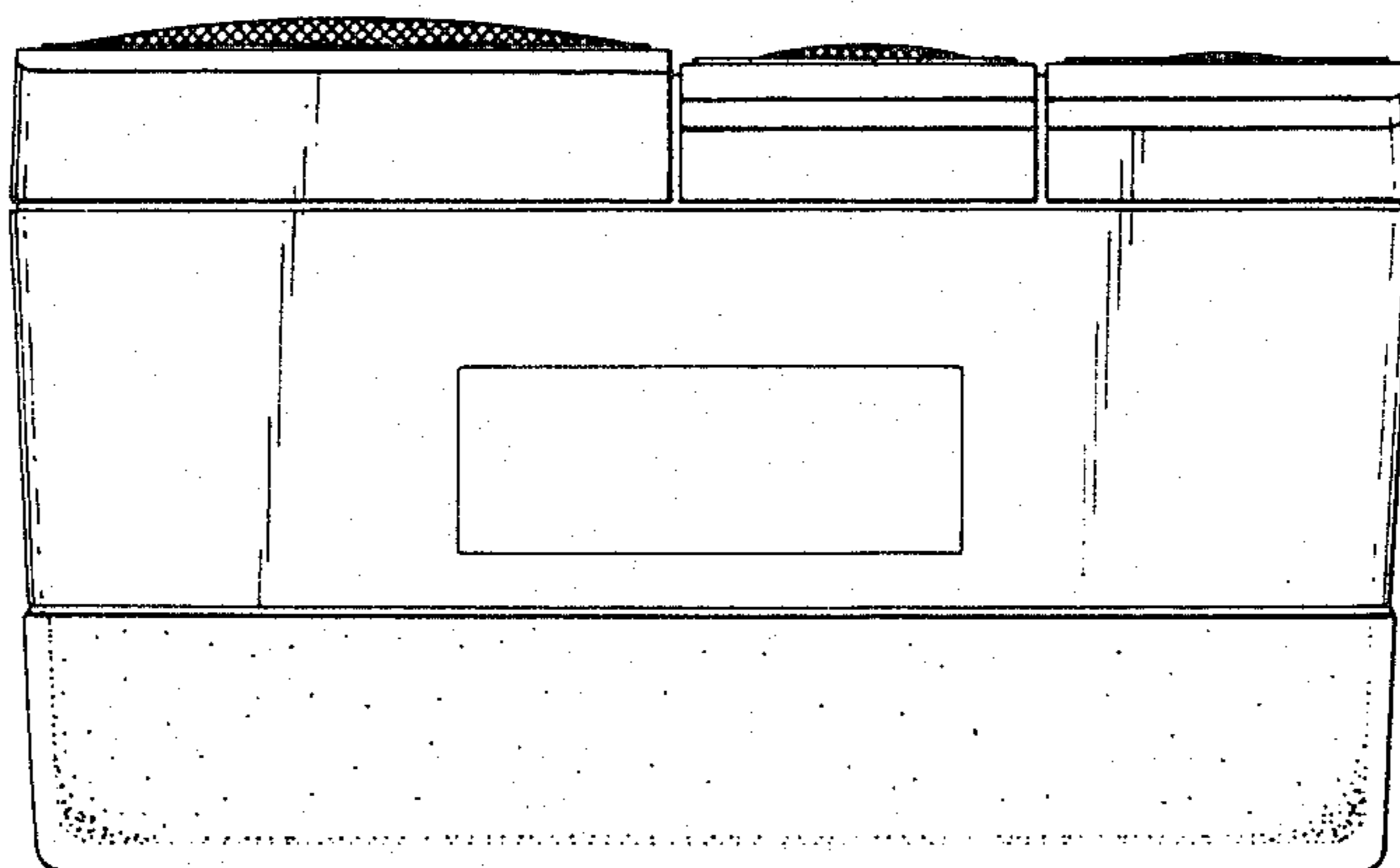

FIG. 5

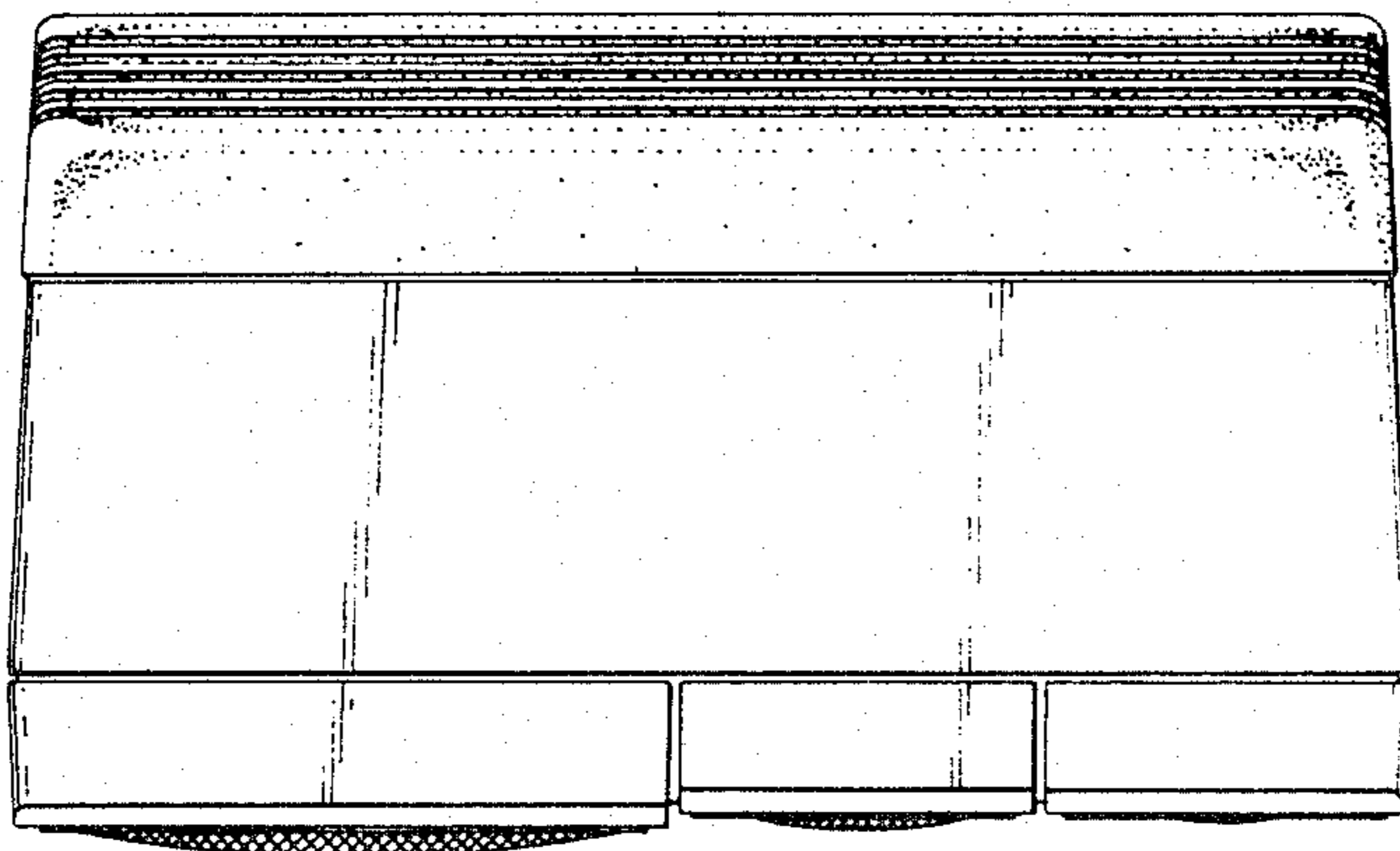

FIG. 6

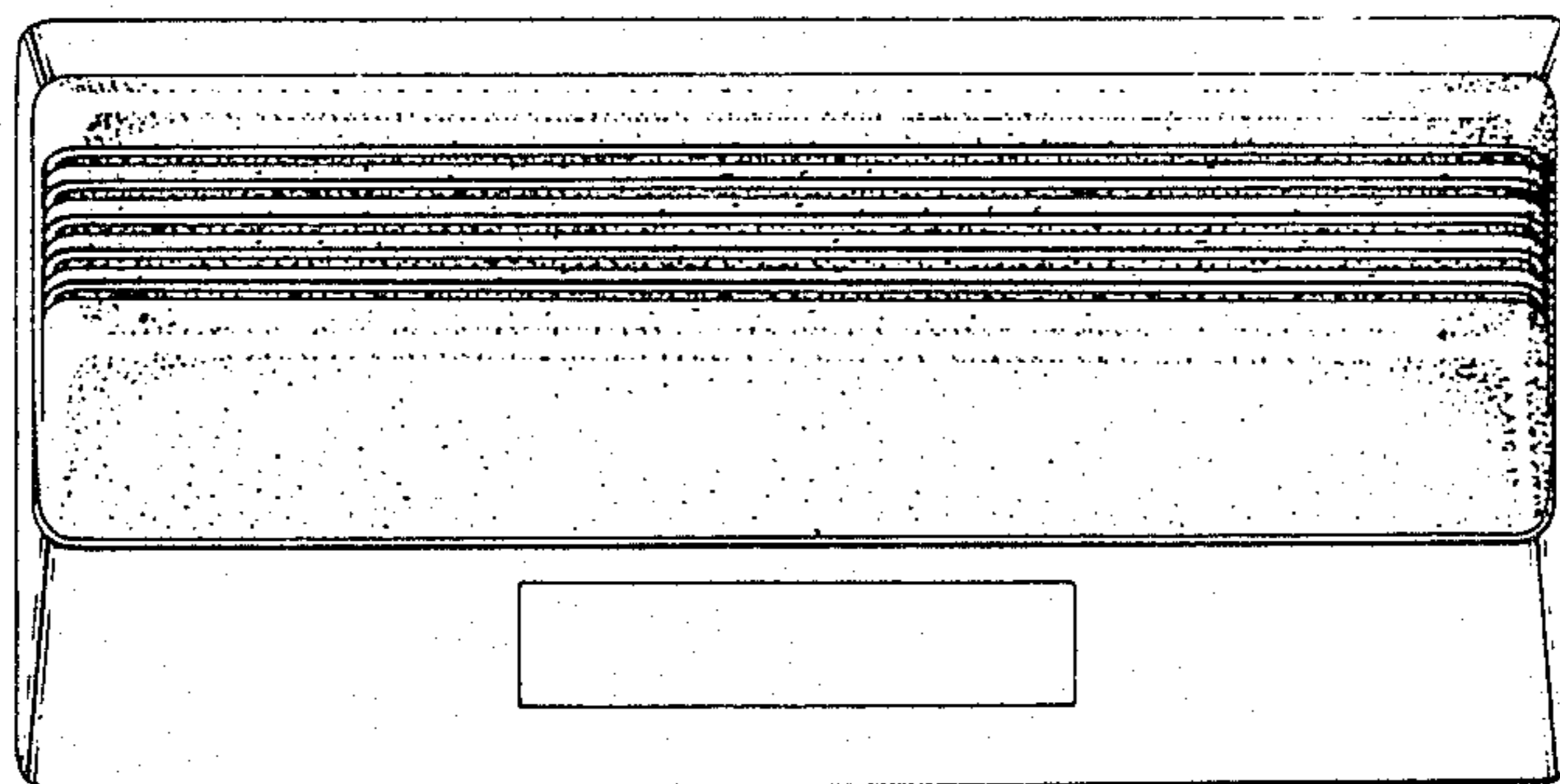

FIG. 7

