

[54] HAIR DRYER WITH ATTACHMENTS

[75] Inventor: John Wistrand, New Canaan, Conn.

[73] Assignee: Clairol Incorporated, New York, N.Y.

[**] Term: 14 Years

[21] Appl. No.: 167,511

[22] Filed: Jul. 11, 1980

[52] U.S. Cl. D28/13; D28/18

[58] Field of Search D28/03; D28/10-19, D28/25, 35; 34/96-98; 219/222, 225; 132/7, 9, 37 R

[56] References Cited

U.S. PATENT DOCUMENTS

D. 227,944	7/1973	Tucker	D28/13
D. 232,489	8/1974	Long	D28/13
D. 232,665	9/1974	Greubel	D28/12
D. 238,210	12/1975	Lombard et al.	..	
D. 246,605	12/1977	Cousins et al.	D28/13
D. 248,048	5/1978	Cousins et al.	..	
D. 252,472	7/1979	Wistrand	..	
D. 253,253	10/1979	Rakocy	..	
D. 256,846	9/1980	Haase	D28/13
2,678,376	5/1954	Lockwood	..	
3,702,616	11/1972	Mercer	..	
3,854,489	12/1974	Doyle et al.	..	
3,937,231	2/1976	Tucker et al.	..	

FOREIGN PATENT DOCUMENTS

2307992 8/1974 Fed. Rep. of Germany

OTHER PUBLICATIONS

Form, 1/1976, p. 79-Dryer at top left.

Home Furnishings Daily, Thurs. 12/18/75, p. 8-Supermax 2 at top right.

Gillette Package insert for its Supermax Styler 1200-1980.

Primary Examiner—Louis S. Zarfes

Attorney, Agent, or Firm—Isaac Jarkovsky; John J. Balsler; Gerald S. Rosen

[57] CLAIM

The ornamental design for a hair dryer with attachments, substantially as shown and described.

DESCRIPTION

FIG. 1 is a front elevational view of a hair dryer showing my new design;
 FIG. 2 is a side elevational view thereof;
 FIG. 3 is a front and plan view thereof;
 FIG. 4 is a back elevational view thereof;
 FIG. 5 is a back end plan view thereof;
 FIG. 6 is a side elevational view of the hair dryer of my new design with comb attachment;
 FIG. 7 is a top plan view of the comb attachment for the dryer of my new design;
 FIG. 8 is an end elevational view of the comb attachment;
 FIG. 9 is a side elevational view of the comb attachment;
 FIG. 10 is a bottom plan view of the comb attachment;
 FIG. 11 is a side elevational view of the hair dryer of my new design with brush attachment;
 FIG. 12 is a top plan view of the brush attachment;
 FIG. 13 is an end elevational view of the brush attachment;
 FIG. 14 is a side elevational view of the brush attachment; and
 FIG. 15 is a bottom plan view of the brush attachment.

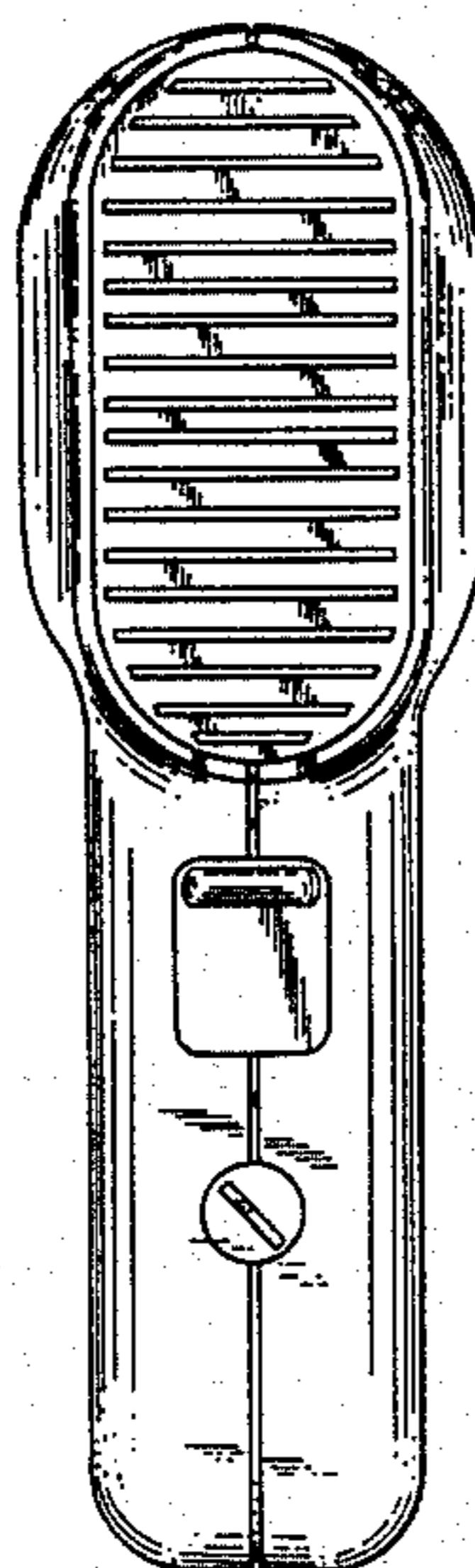

FIG. 1

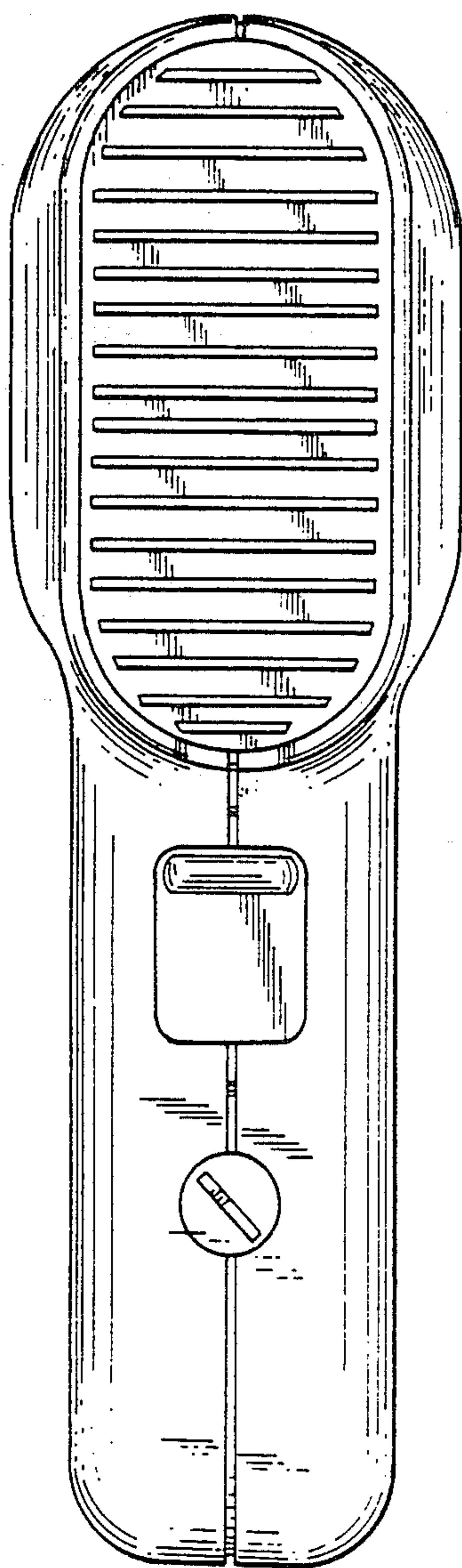

FIG. 2

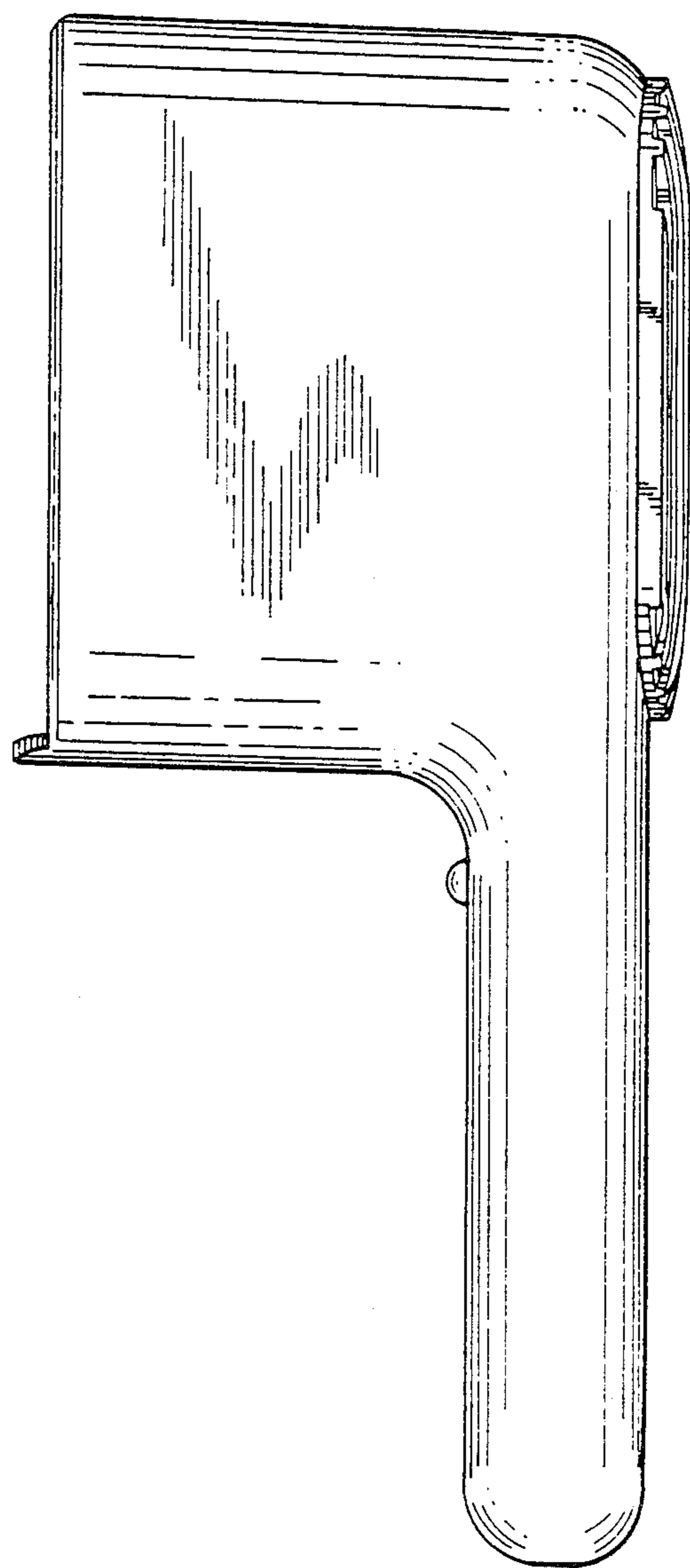

Fig. 3

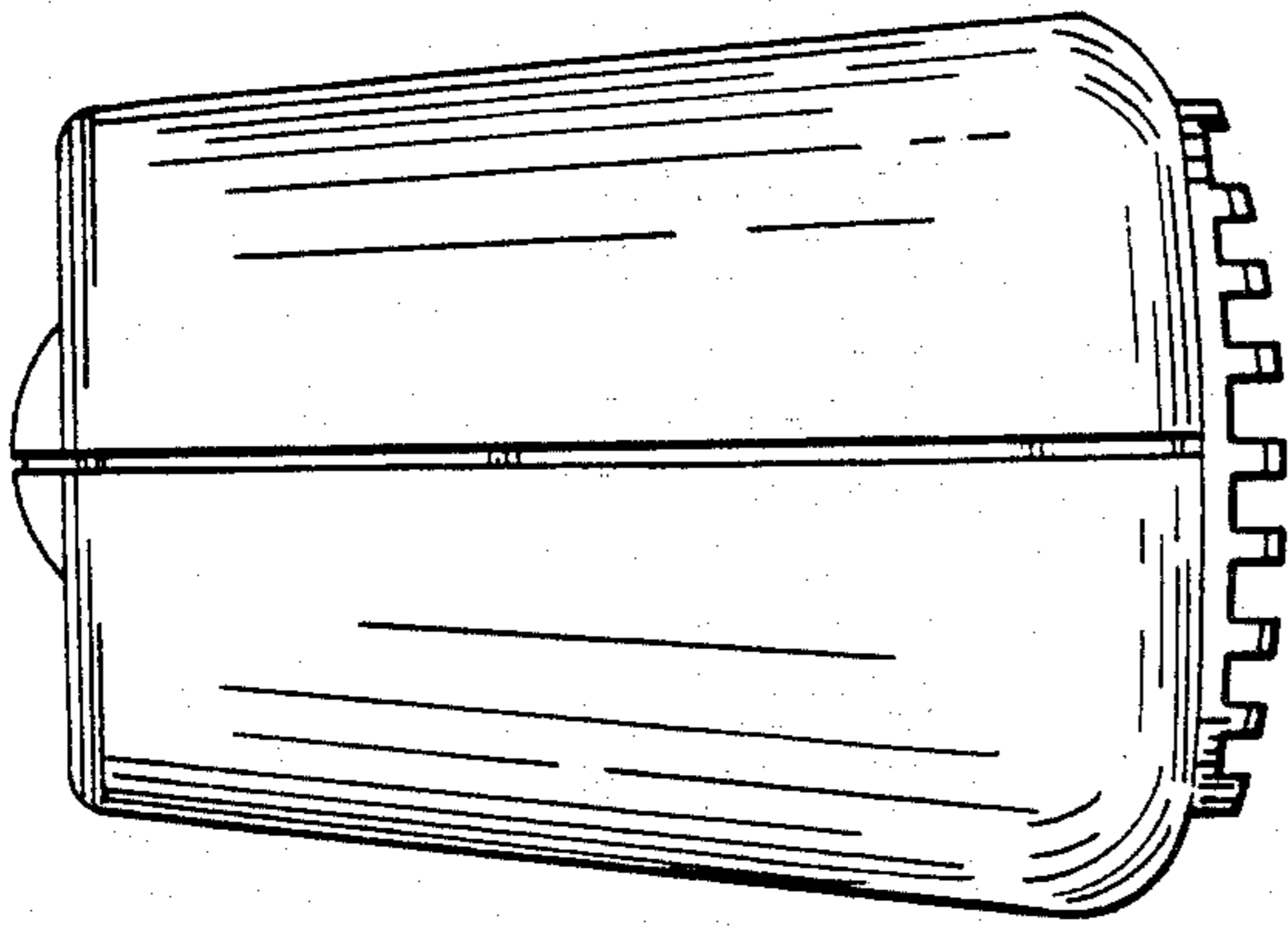

Fig. 4

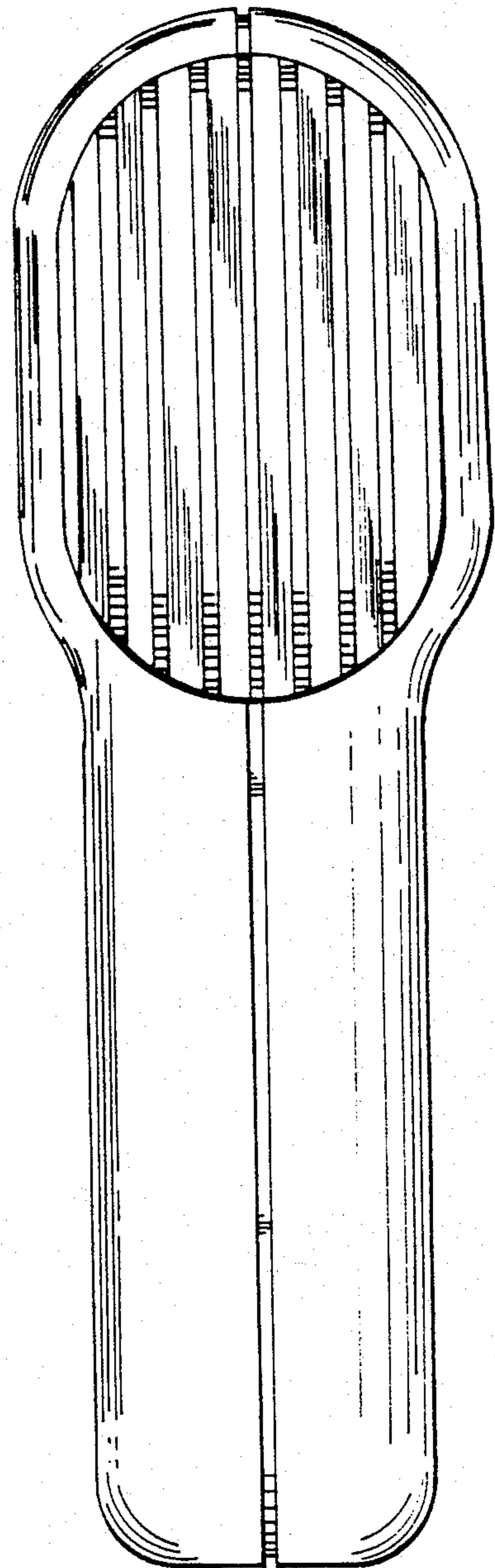
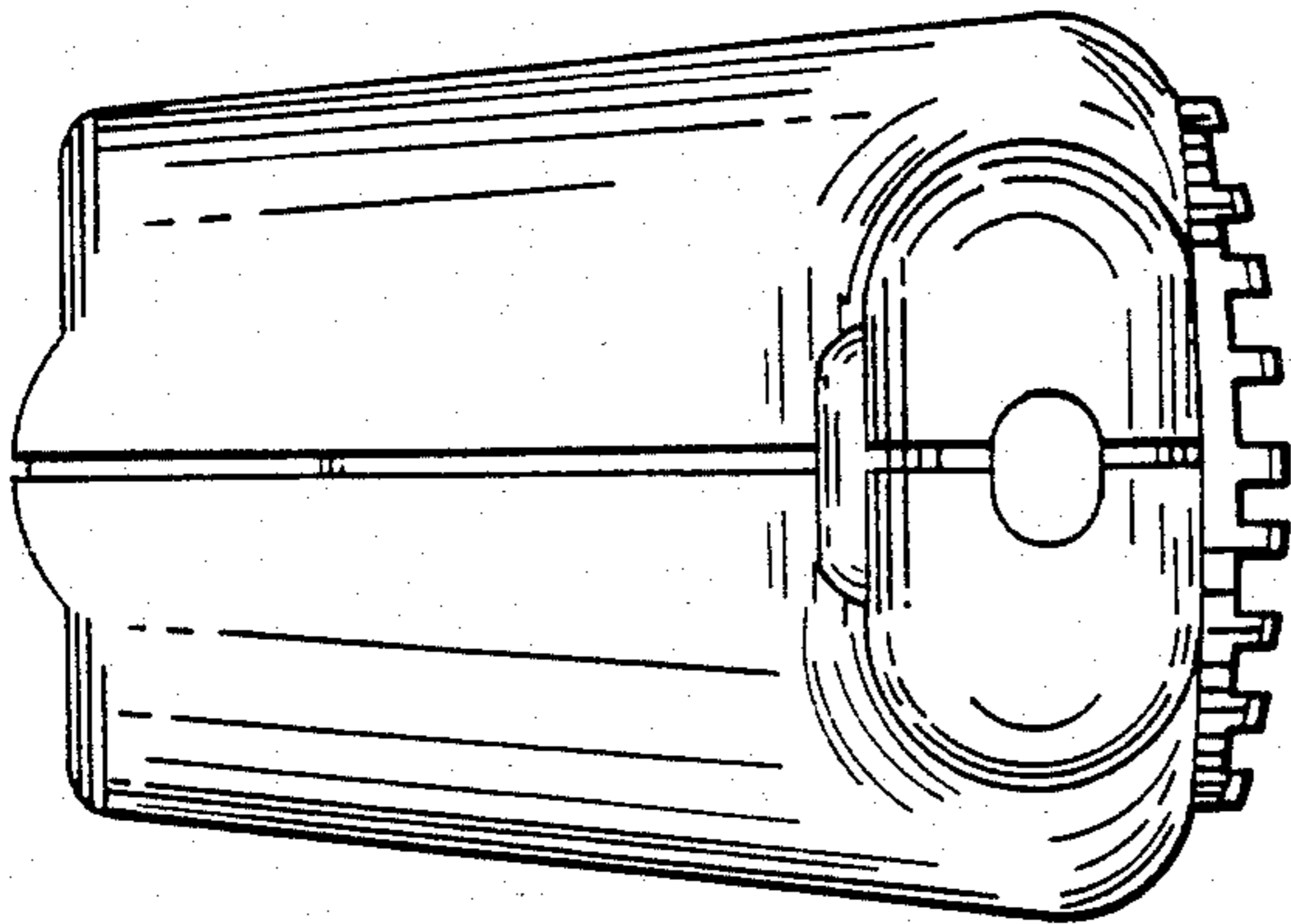

Fig. 5



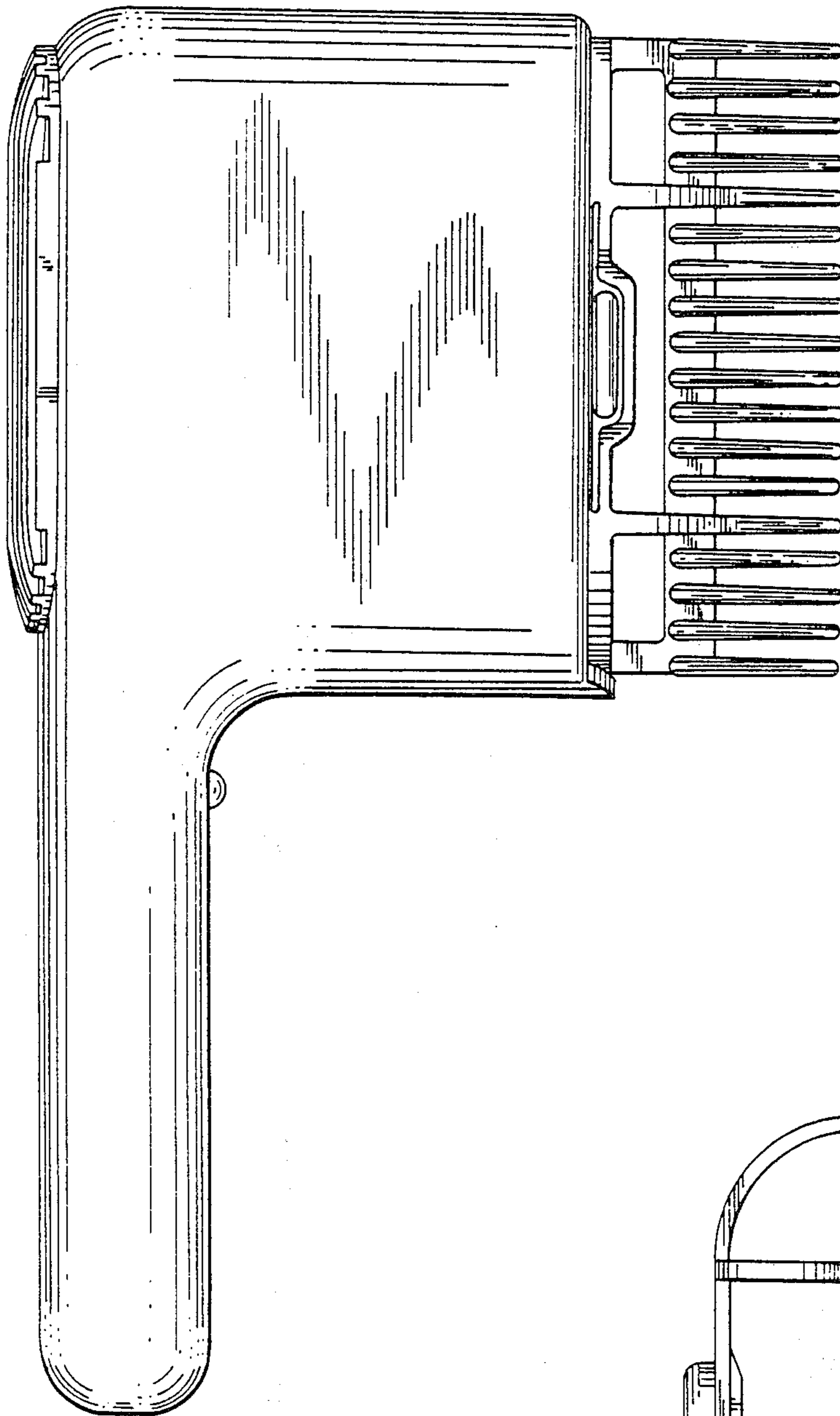

FIG. 6

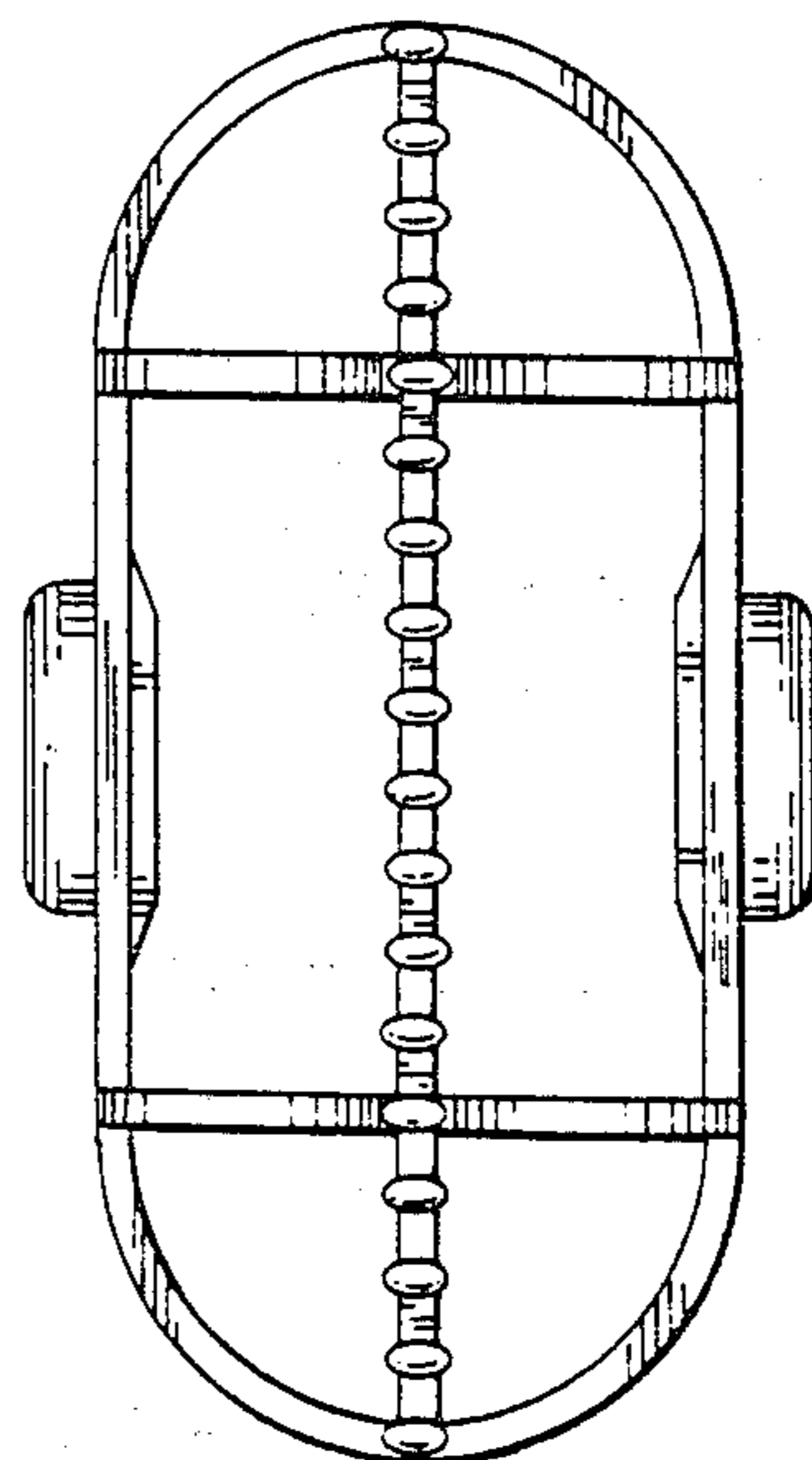

FIG. 7

FIG. 8

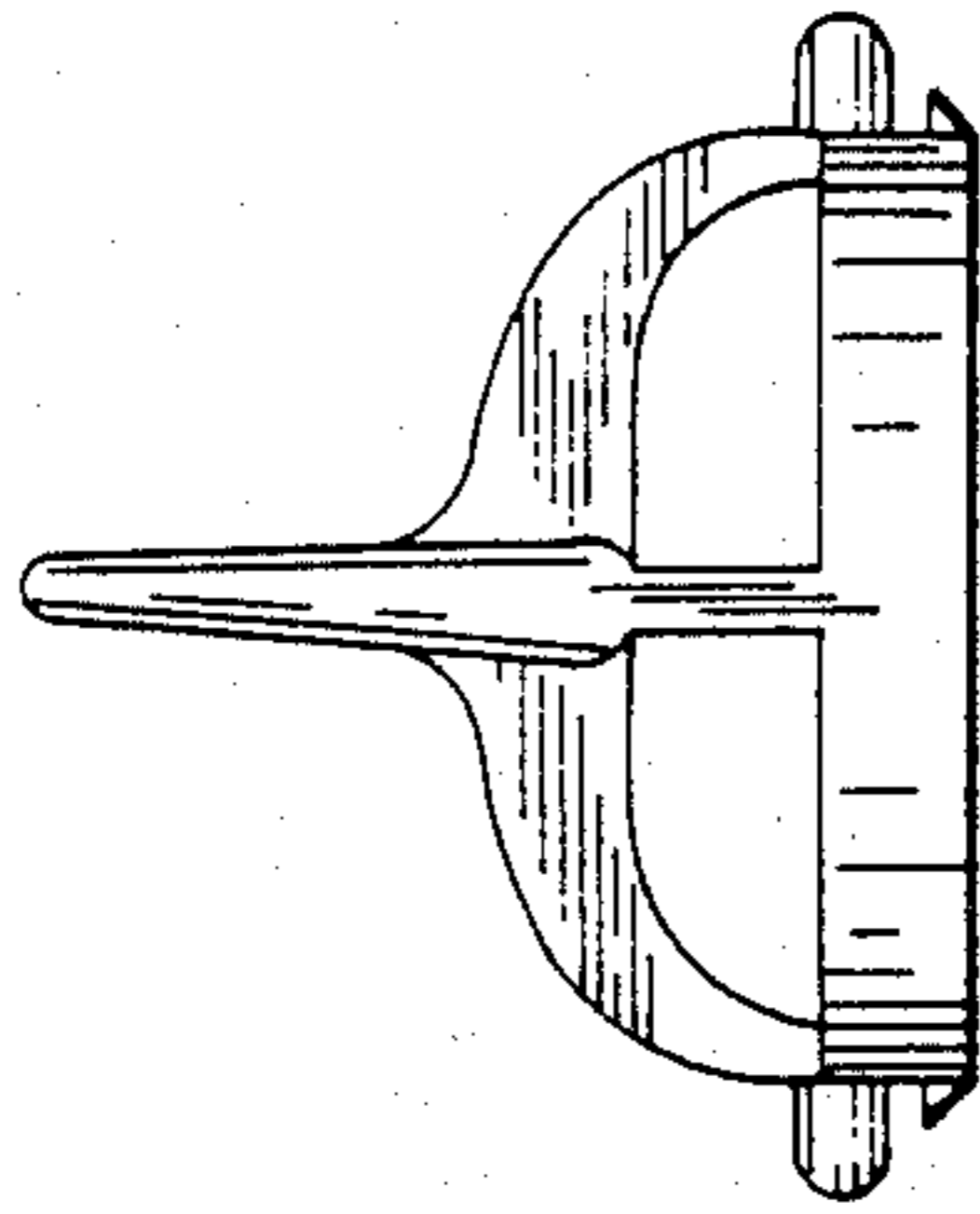

FIG. 9

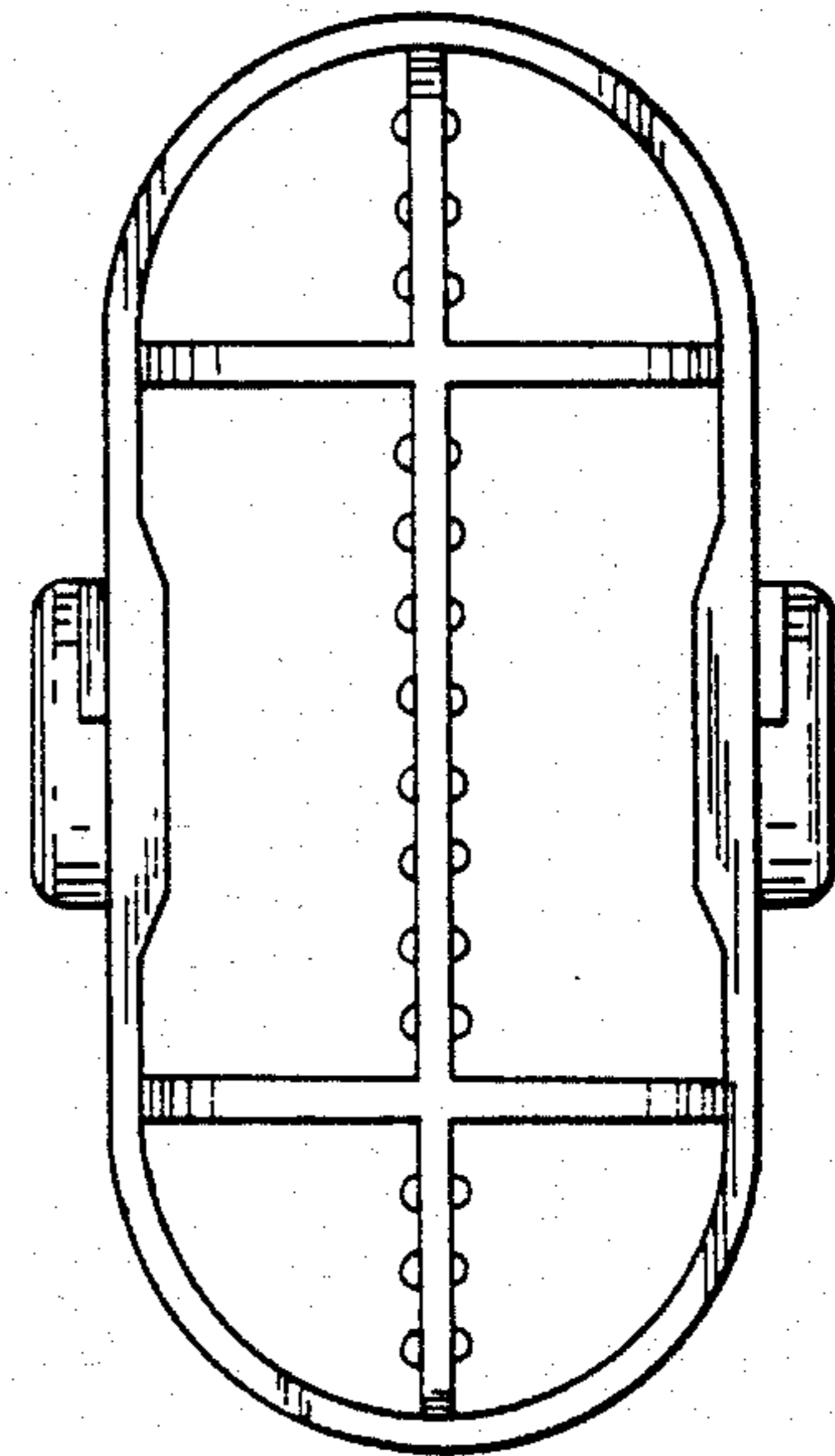
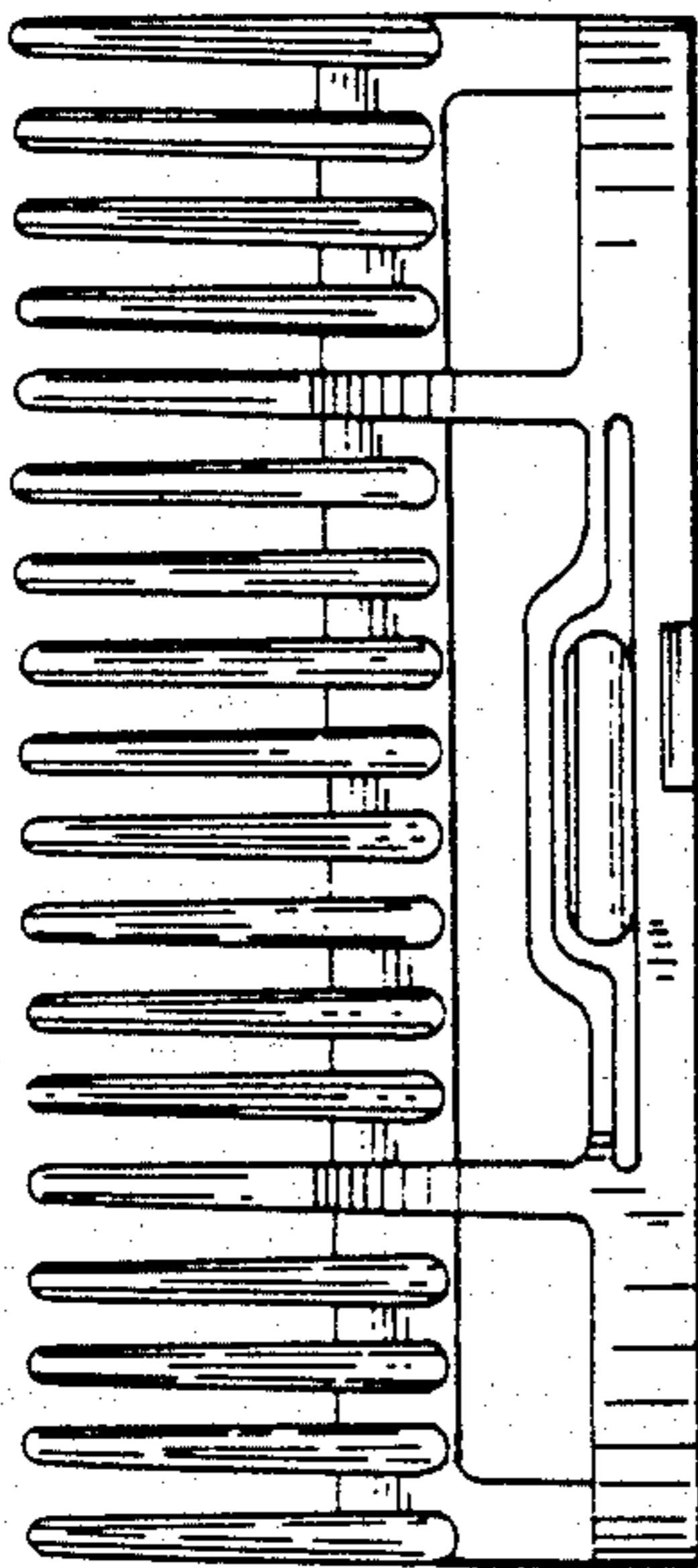

FIG. 10

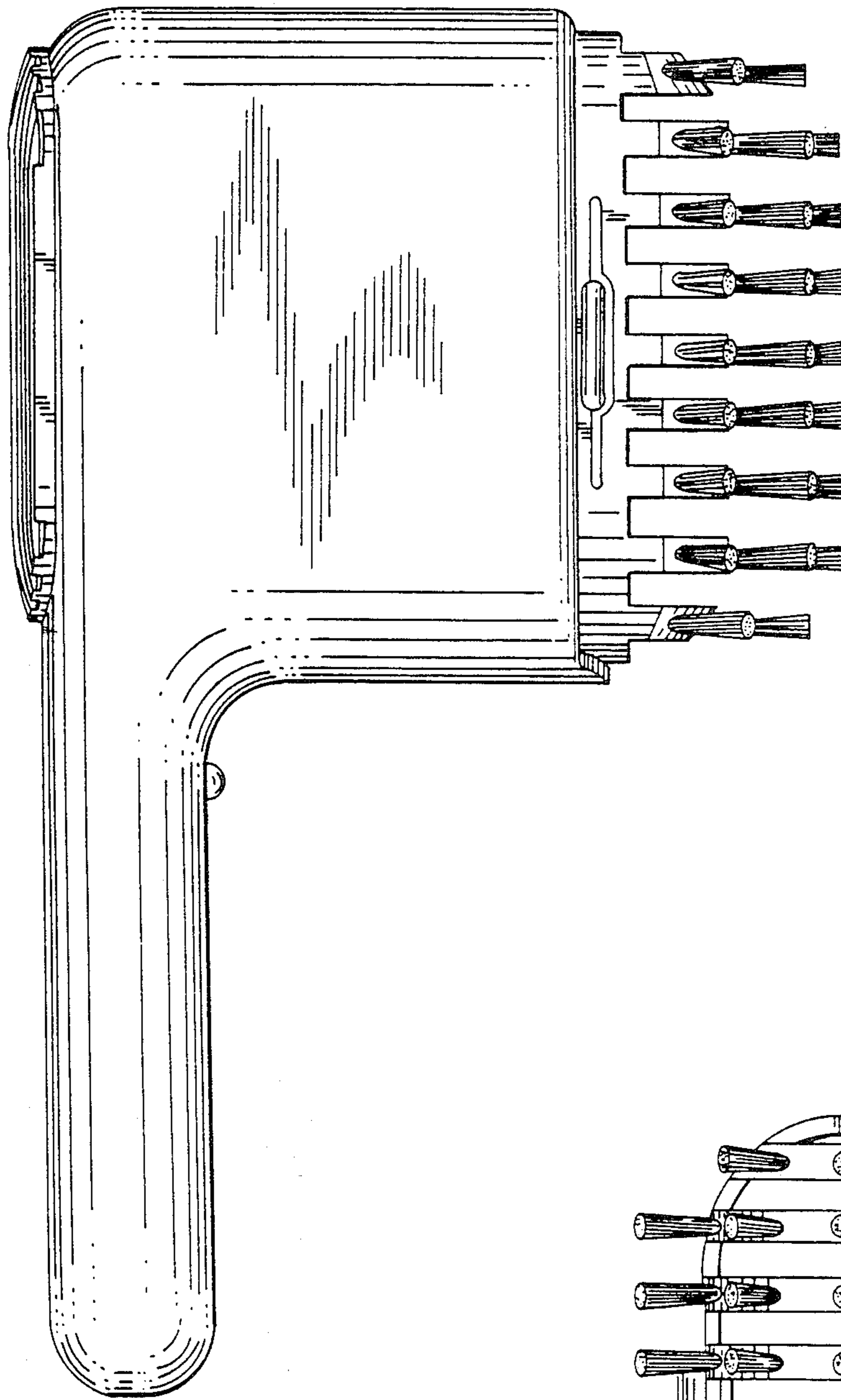

FIG. 11

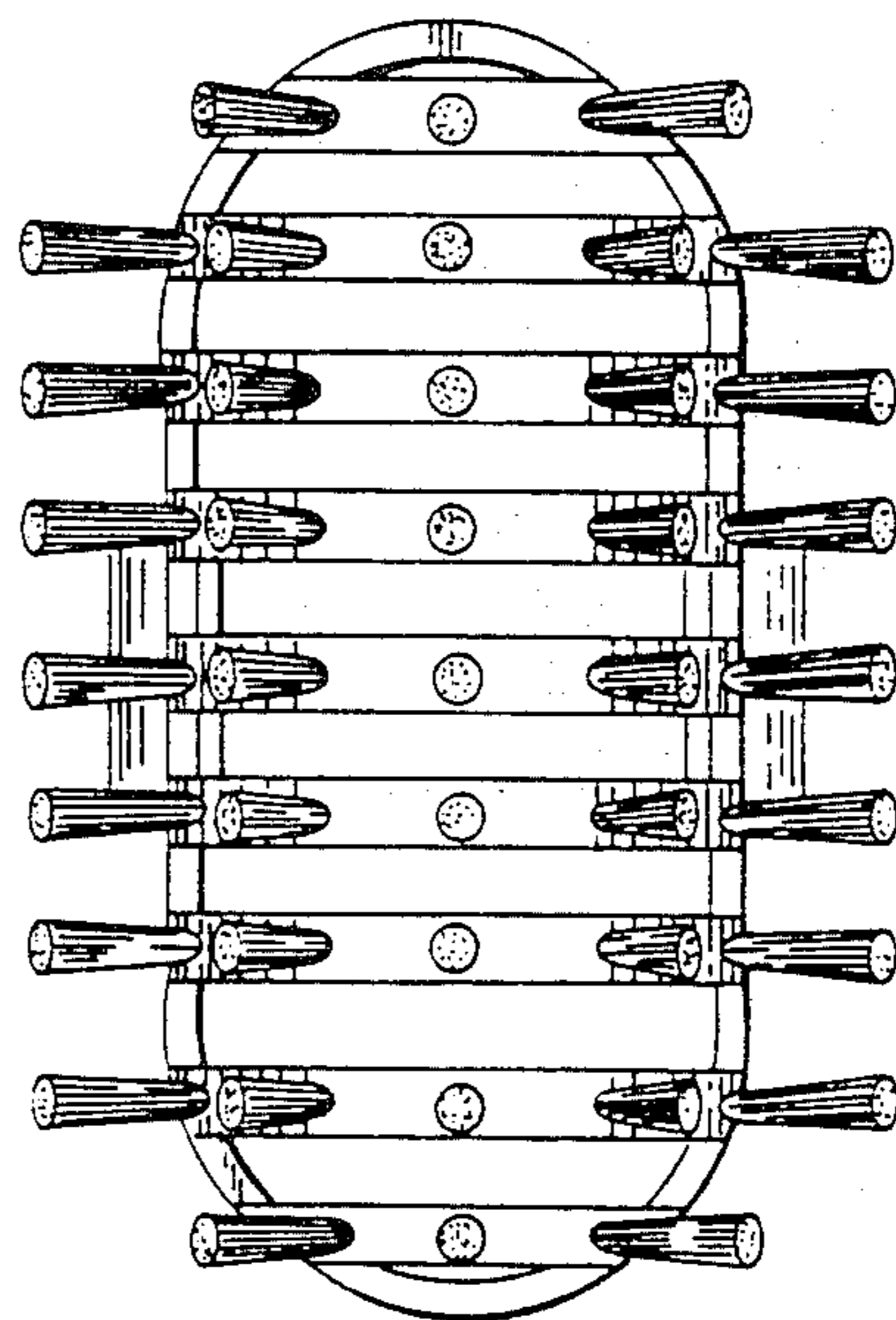

FIG. 12

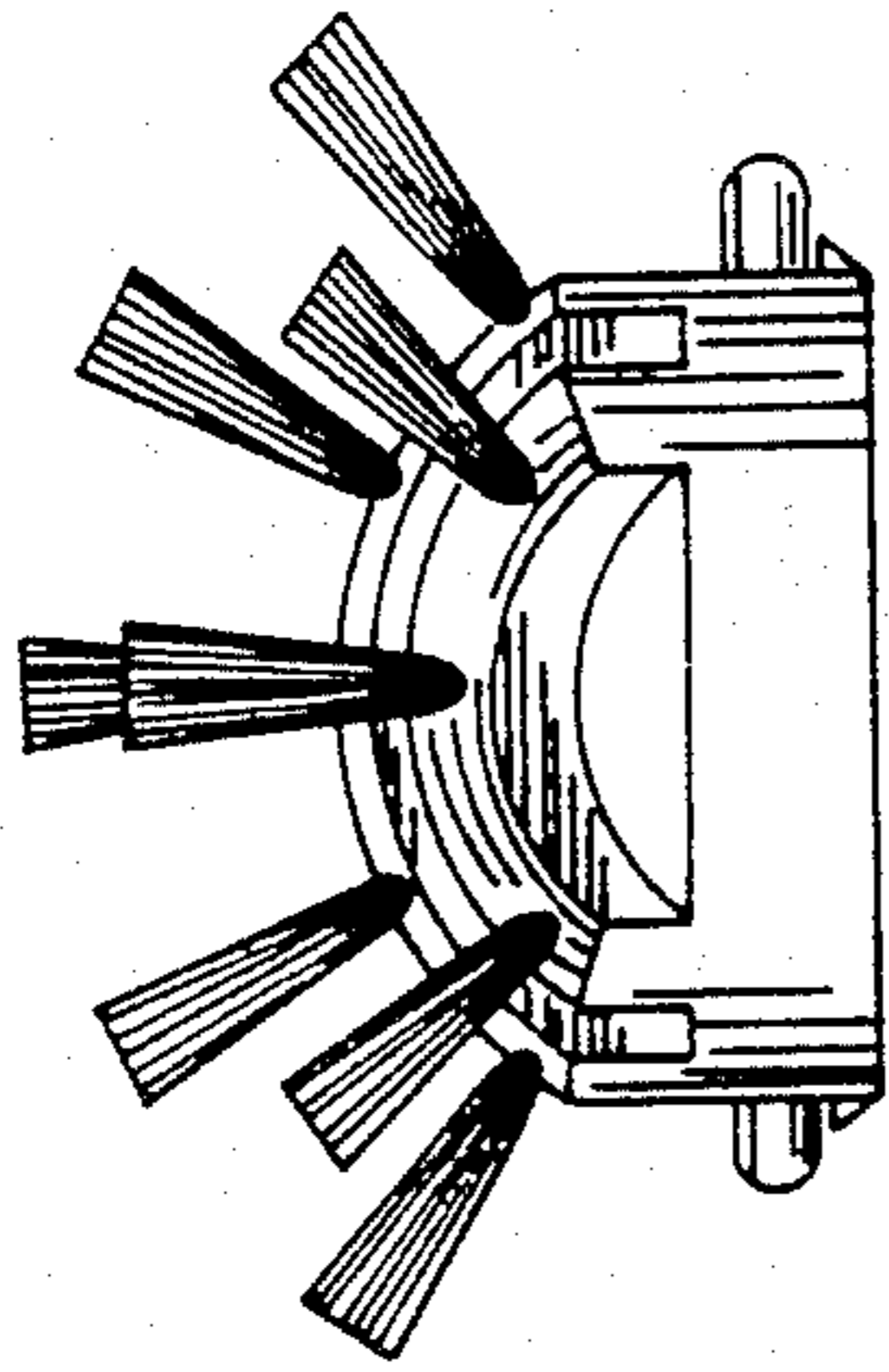

FIG. 13

FIG. 14

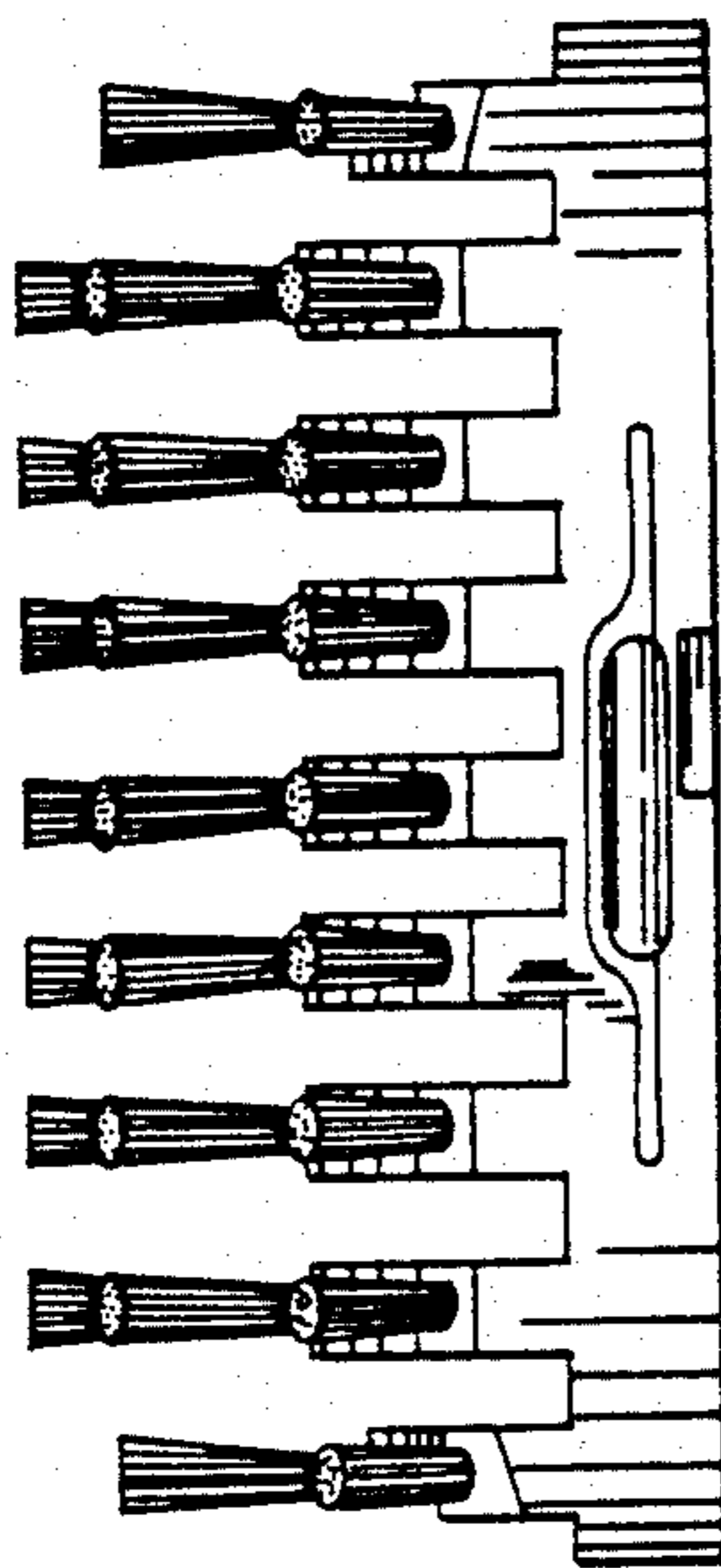

FIG. 15

