

[54] COMBINED STAIRS AND ENCLOSURE FOR A HYDROTHERAPY SPA

[75] Inventors: Alfred W. Elsner; Willard H. Schmitz, both of Plymouth, Wis.

[73] Assignee: Kohler Co., Kohler, Wis.

[**] Term: 14 Years

[21] Appl. No.: 426,210

[22] Filed: Sep. 28, 1982

[52] U.S. Cl. D24/38

[58] Field of Search D24/36, 37, 38, 99; D25/63, 58, 2; D21/192; 128/366, 66, 367, 369, 365.37; 182/115, 116, 121; D23/55, 56, 57; 4/513, 488, 506, 538

[56] References Cited

U.S. PATENT DOCUMENTS

D. 260,929	9/1981	Haller	D24/38
D. 270,567	9/1983	Conlin	D24/38
D. 271,137	10/1982	Kohler et al.	D24/38
3,755,981	9/1973	West	4/506

OTHER PUBLICATIONS

Encon Acrylics, Nov. 5, 1981, p. 1, Spas A-C on left side.

Page 2 of a Crown Spas advertisement entitled "Crown Terrazzo Style Acrylic Spas, The Ultimate In Lasting Beauty", undated, admitted prior art, showing a box-like surround.

Page 2 of a Luv Spas Int'l. Inc. advertisement, dated 1978, entitled "The Anywhere Spa Means Portability" showing box-like surrounds used with the Gatsby & Champagne spas.

Primary Examiner—B. J. Bullock

Assistant Examiner—Suzanne N. Gitlin

Attorney, Agent, or Firm—Quarles & Brady

[57] CLAIM

The ornamental design for a combined stairs and enclosure for a hydrotherapy spa, as shown.

DESCRIPTION

FIG. 1 is a perspective view of a combined stairs and enclosure for a hydrotherapy spa showing our new design;

FIG. 2 is a second perspective view thereof;

FIG. 3 is a top plan view thereof;

FIG. 4 is a side elevational view taken in the direction of the arrows on line 4—4 of FIG. 3;

FIG. 5 is a front elevational view taken in the direction of the arrows on line 5—5 of FIG. 3.

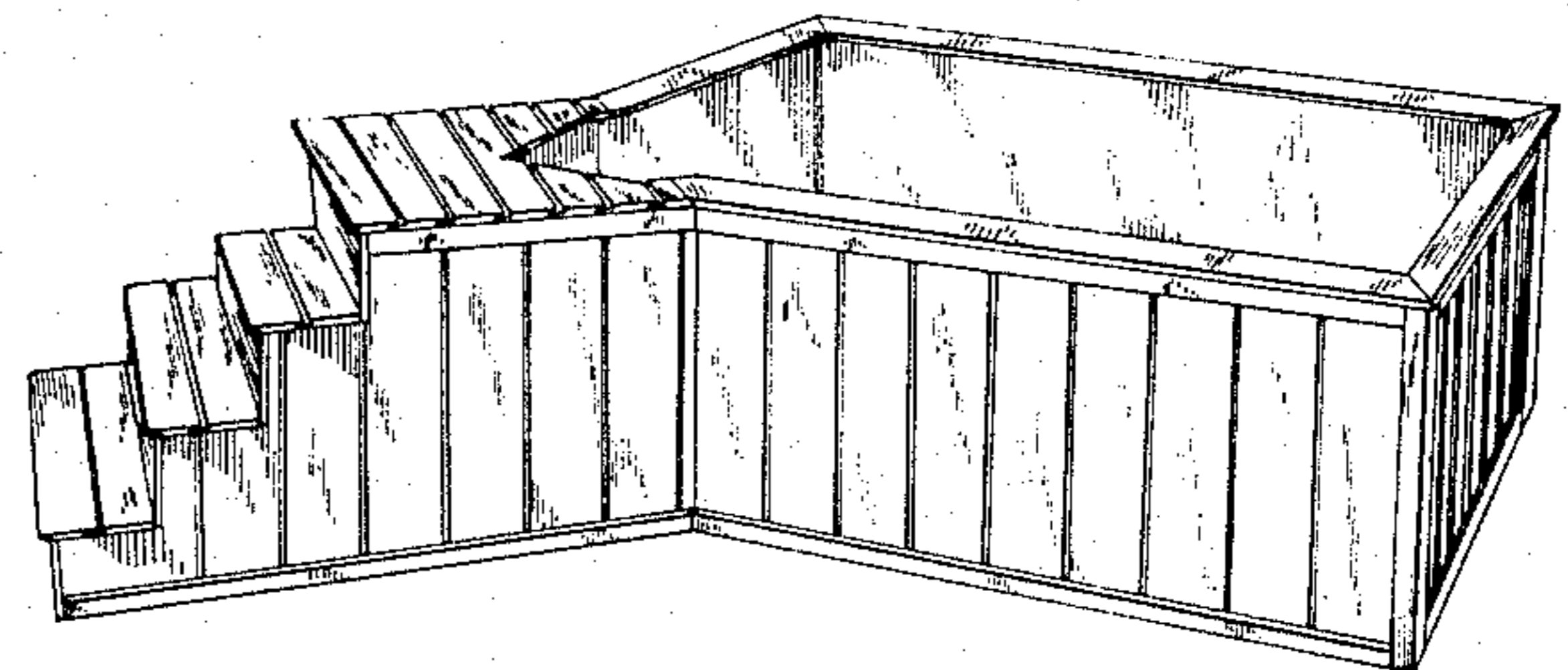
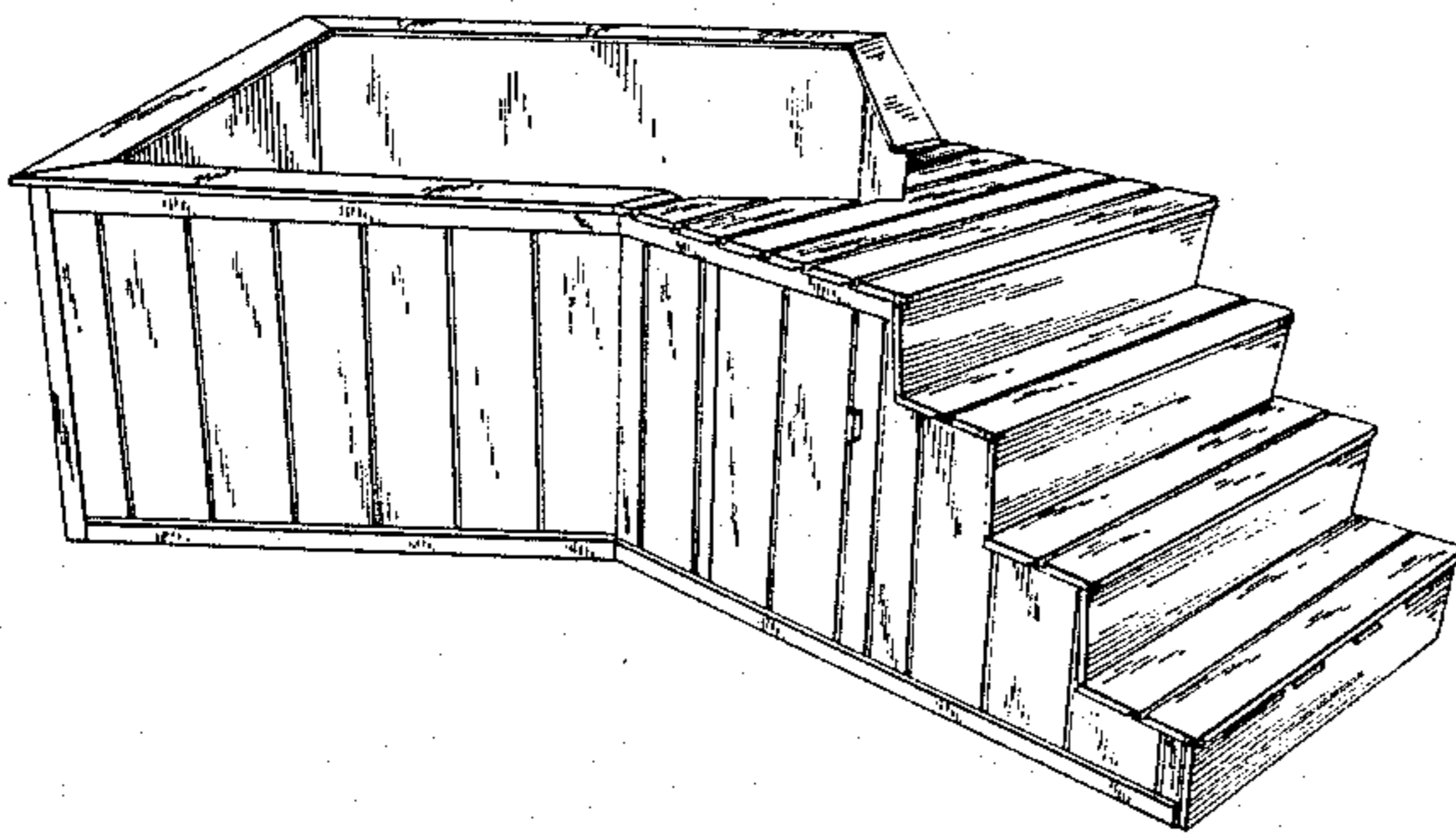

Fig. 1

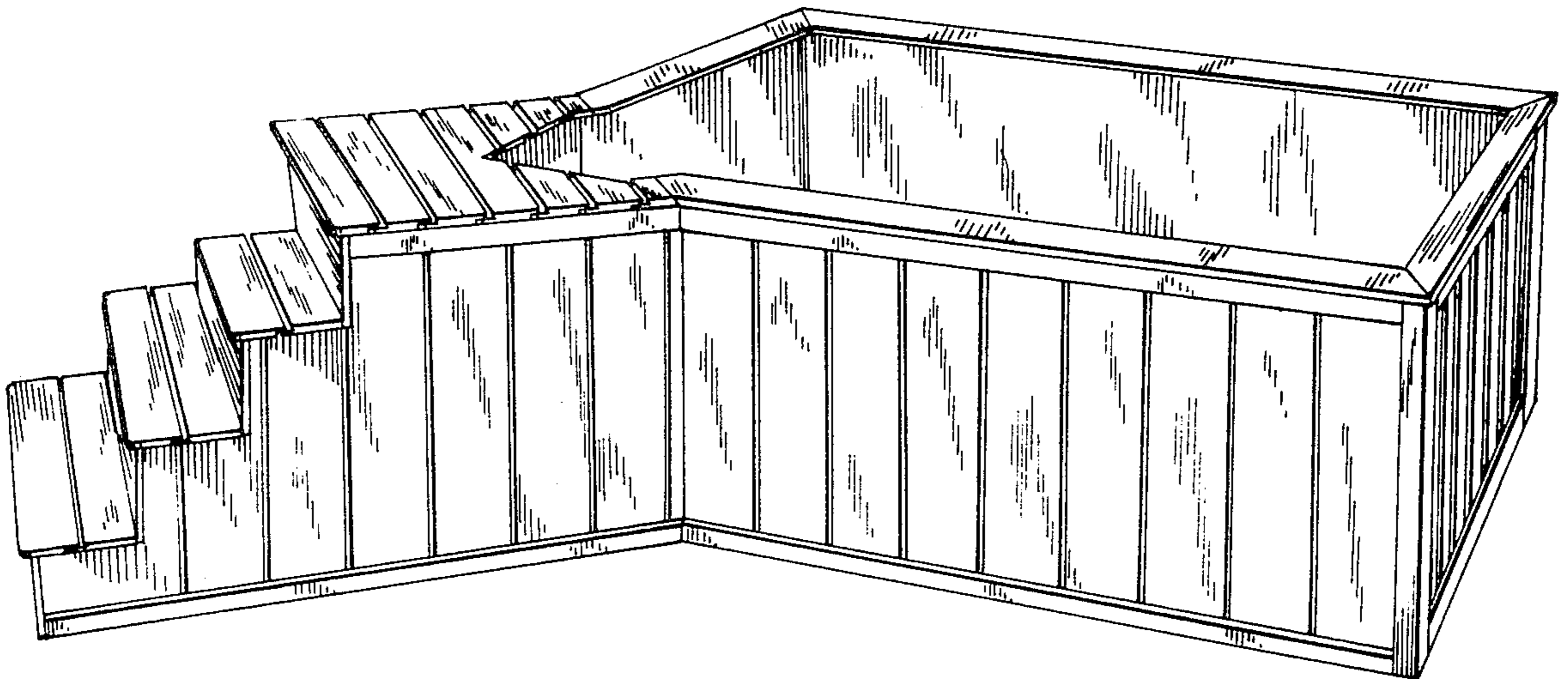
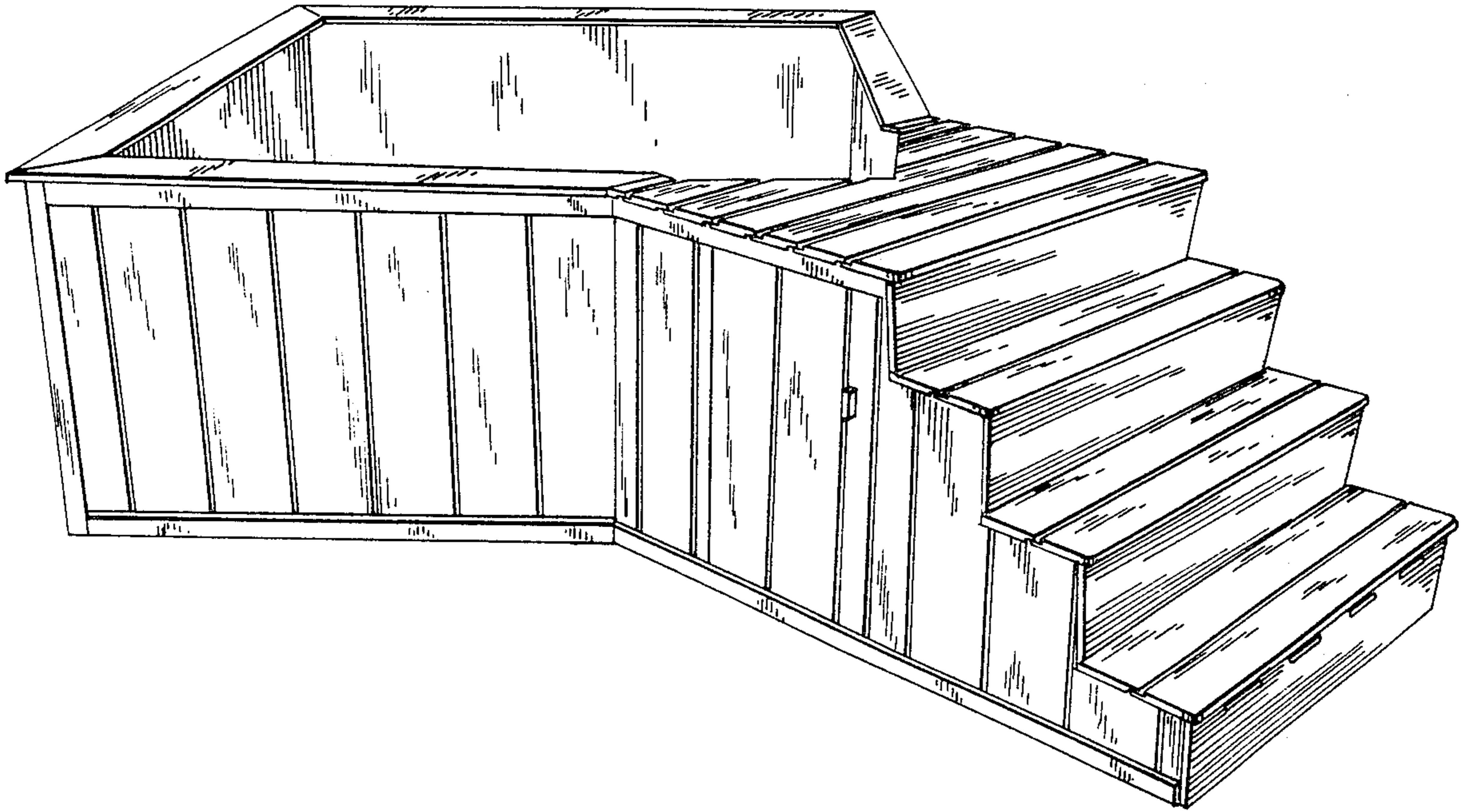

Fig. 2

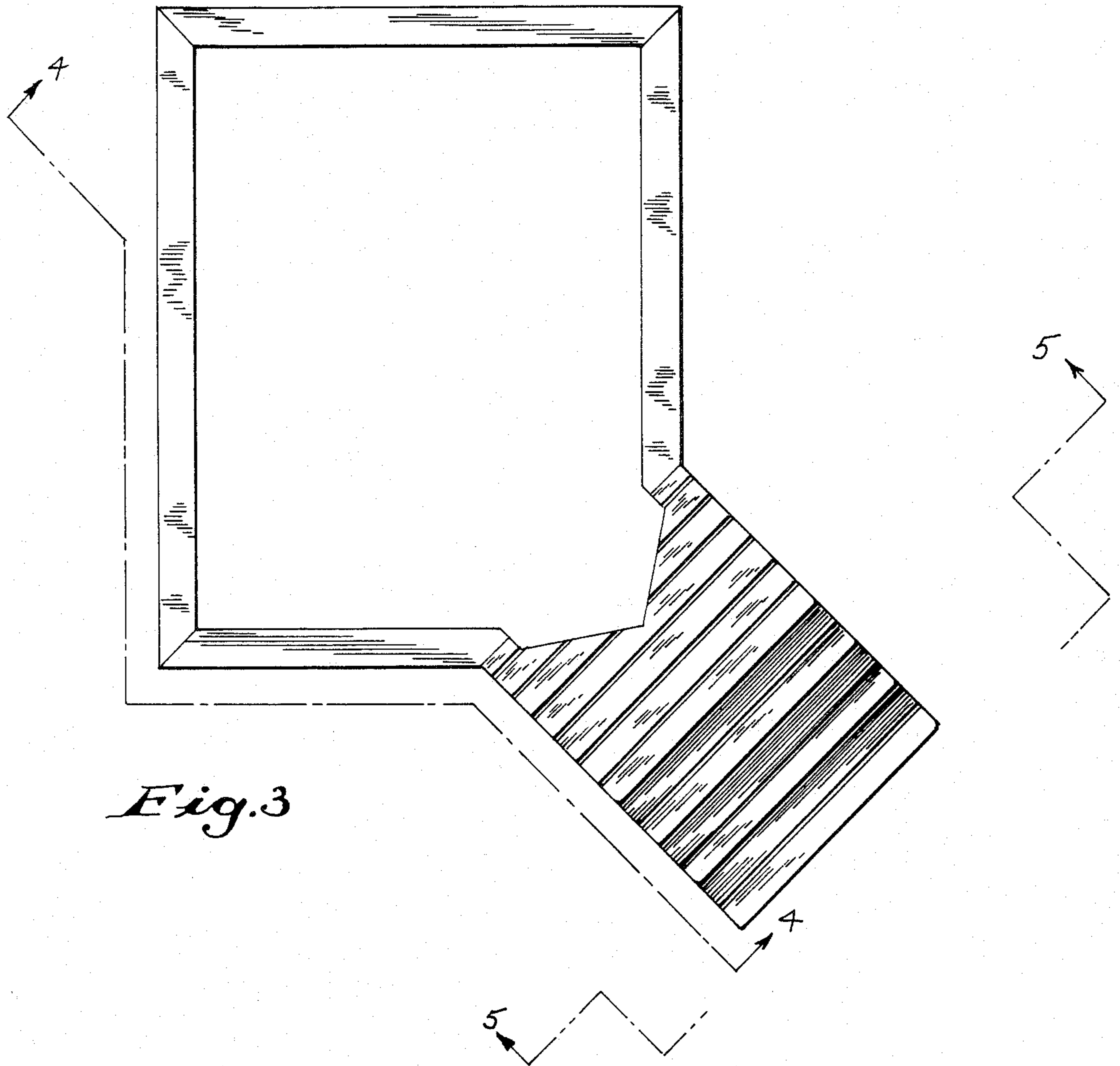

Fig. 3

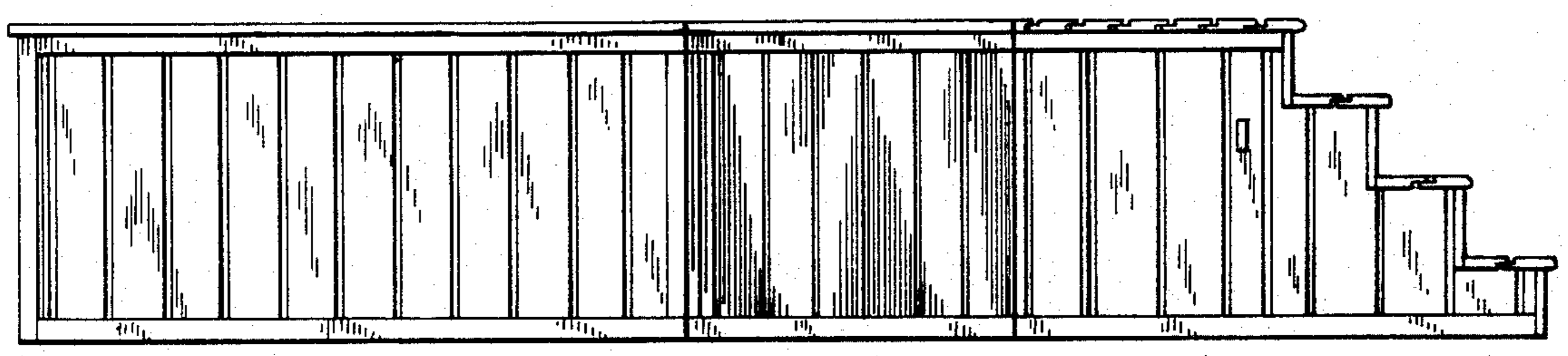

Fig. 4

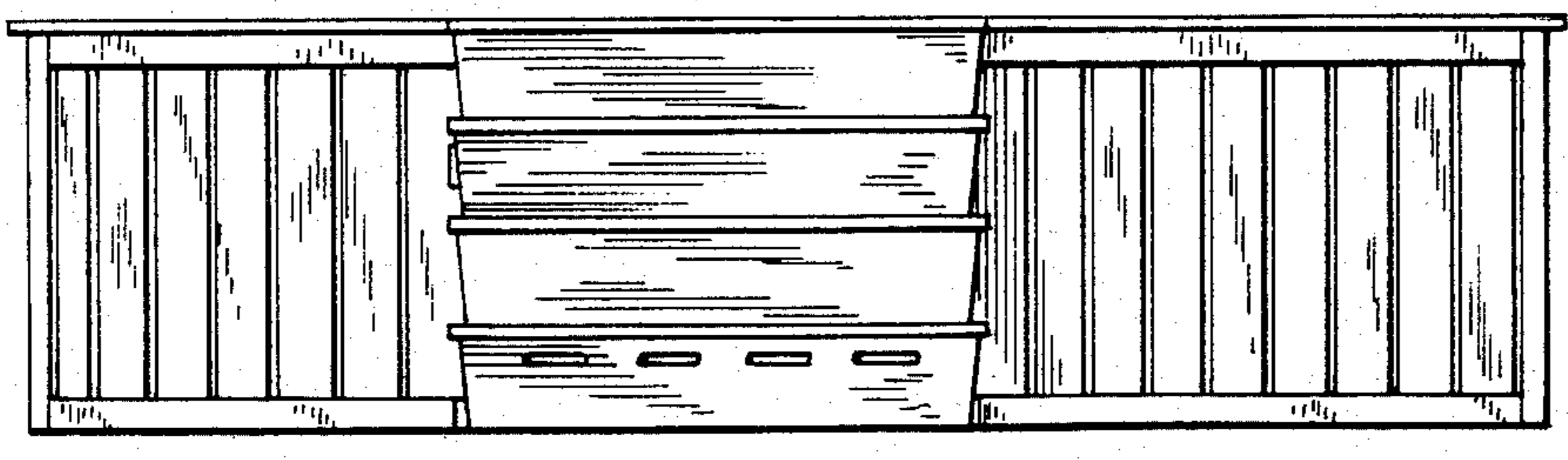

Fig. 5