

[54] STEERING WHEEL FOR MOTOR VEHICLE

[75] Inventor: Tsutomu Koinuma, Saitama, Japan

[73] Assignee: Honda Giken Kogyo Kabushiki Kaisha, Tokyo, Japan

[\*\*] Term: 14 Years

[21] Appl. No.: 365,879

[22] Filed: Apr. 5, 1982

[30] Foreign Application Priority Data

Oct. 6, 1981 [JP] Japan ..... 56-44253

[52] U.S. Cl. .... D12/176

[58] Field of Search ..... D12/176; 74/552

[56] References Cited

FOREIGN PATENT DOCUMENTS

2410590 8/1979 France ..... 74/552

OTHER PUBLICATIONS

Motor Trend, 3/81, p. 70, Chevrolet Malibu V-6 Steering Wheel, center right side of page.

Primary Examiner—James M. Gandy  
Attorney, Agent, or Firm—Lyon & Lyon

[57] CLAIM

The ornamental design for a steering wheel for motor vehicle, substantially as shown.

DESCRIPTION

FIG. 1 is a front elevation view of a steering wheel for motor vehicle embodying my new design.

FIG. 2 is a side elevation view thereof.

FIG. 3 is a top plan view thereof.

FIG. 4 is a rear elevation view thereof.

FIG. 5 is a bottom plan view thereof.

FIG. 6 is a perspective view thereof.

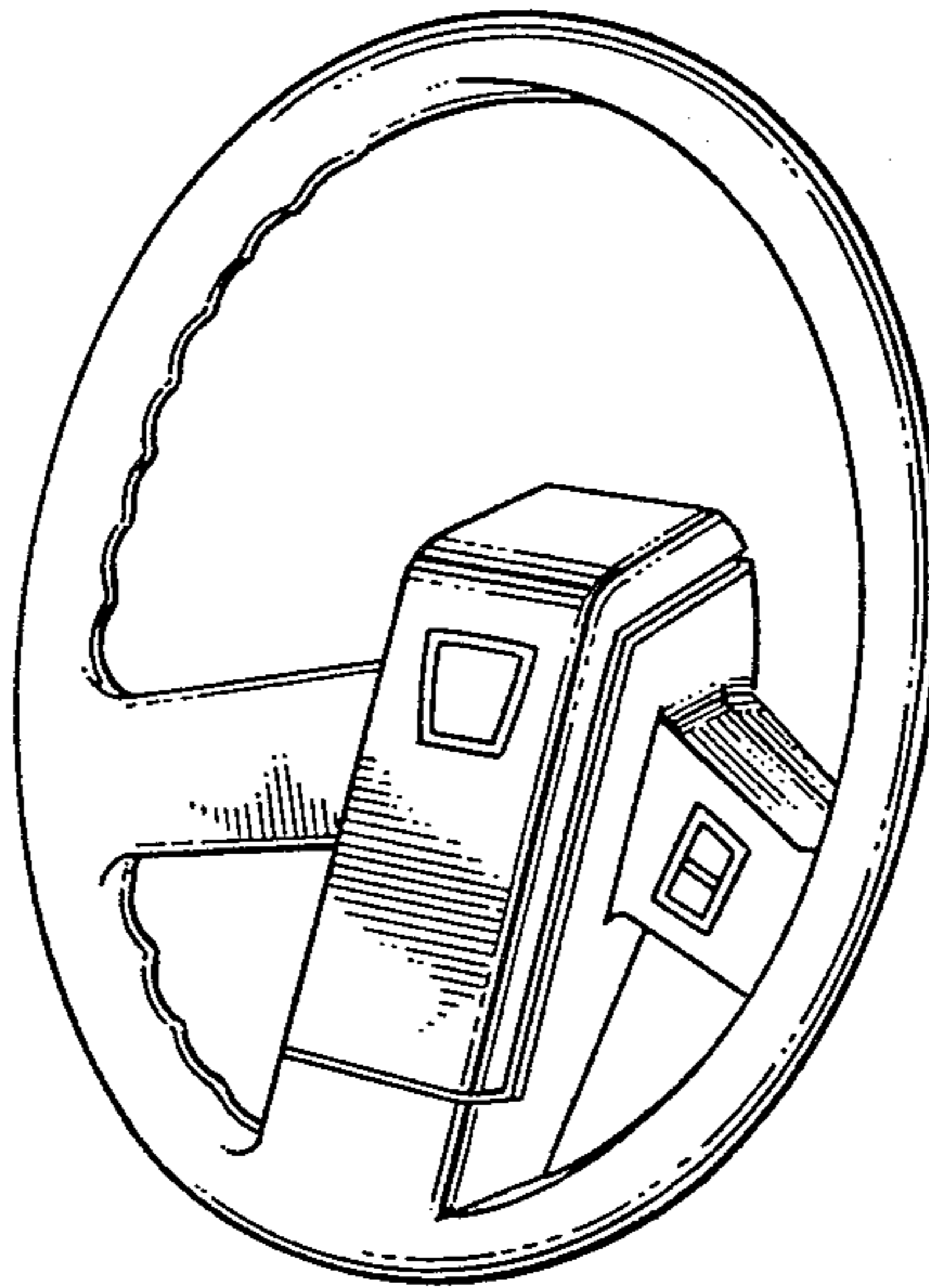

FIG. 1.

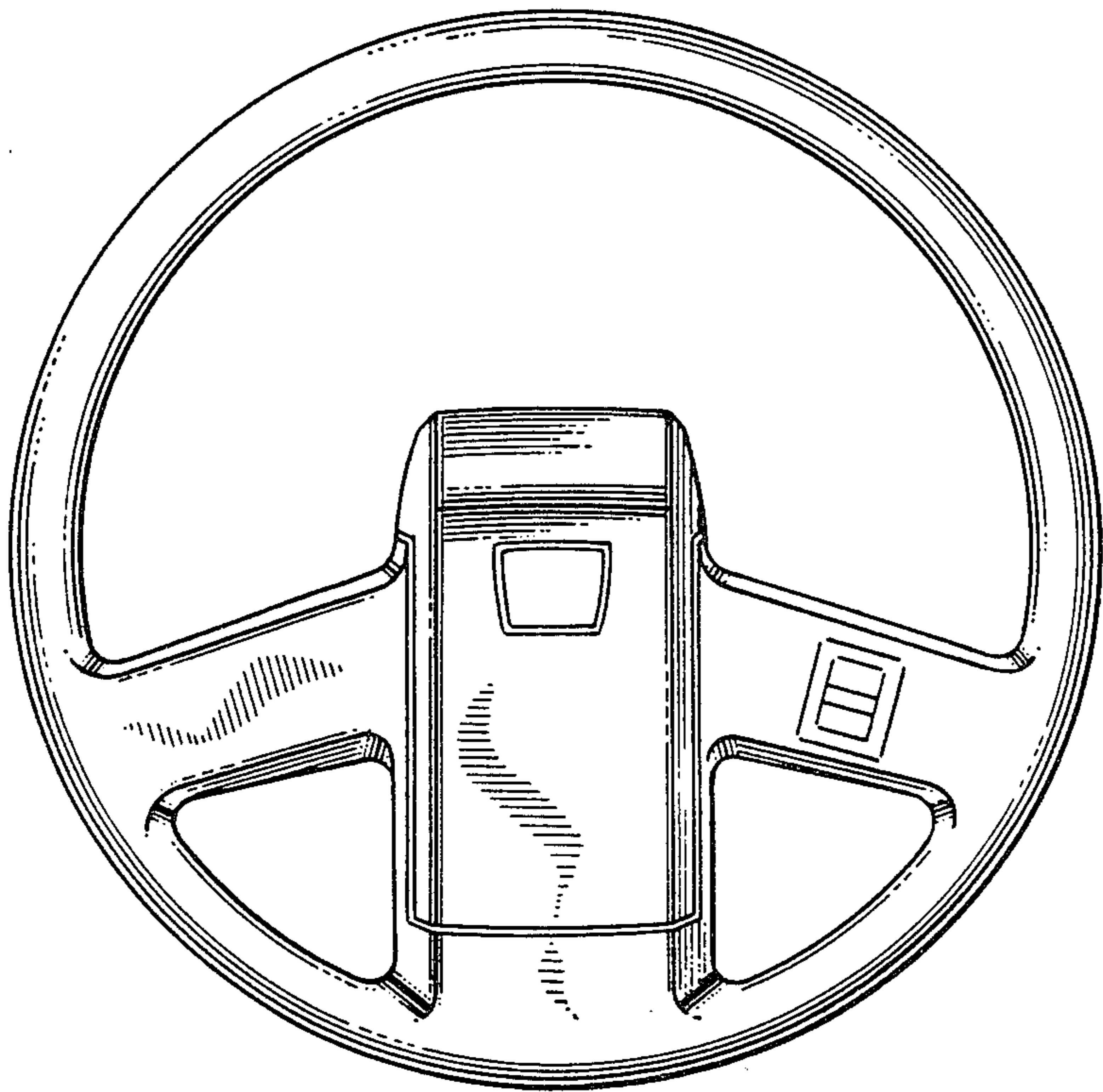

FIG. 2.

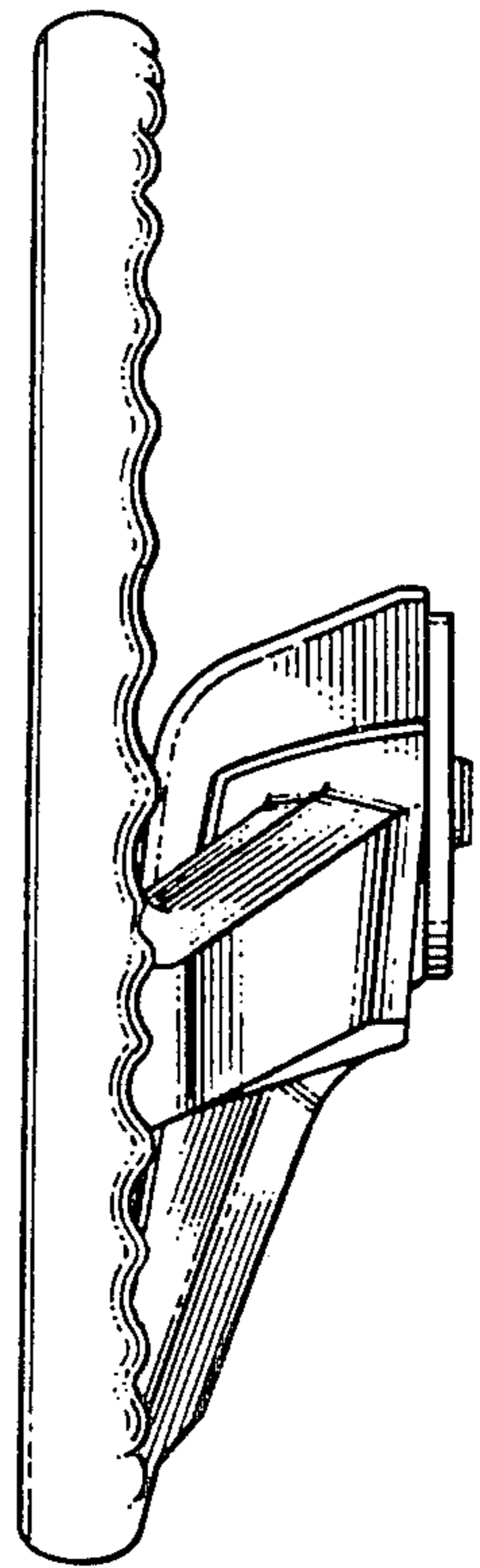
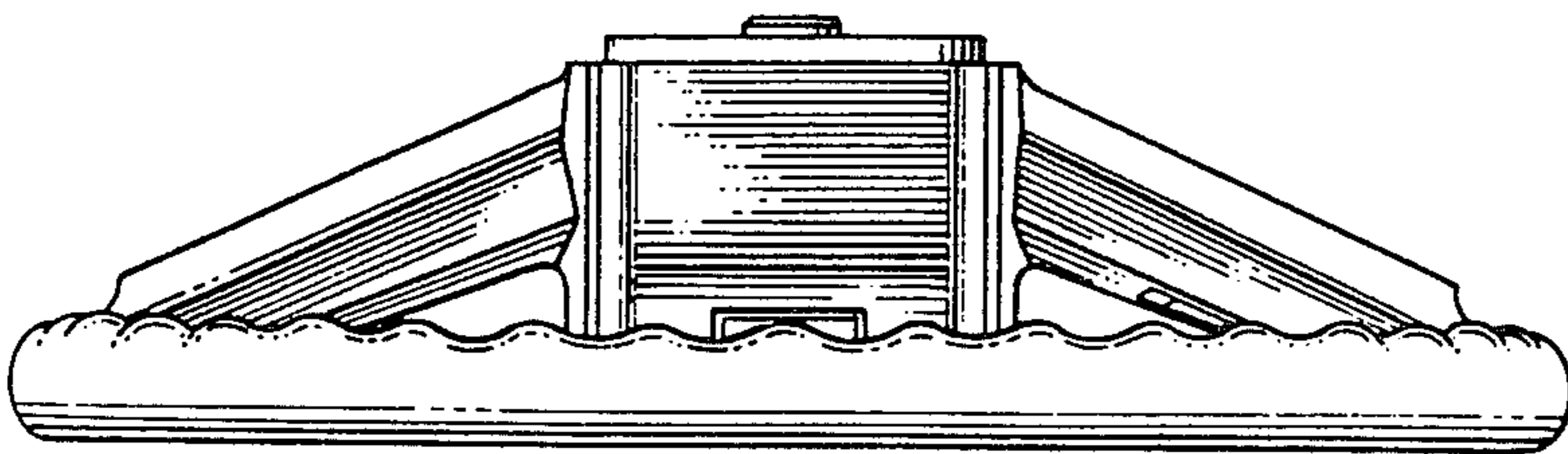

FIG. 3.



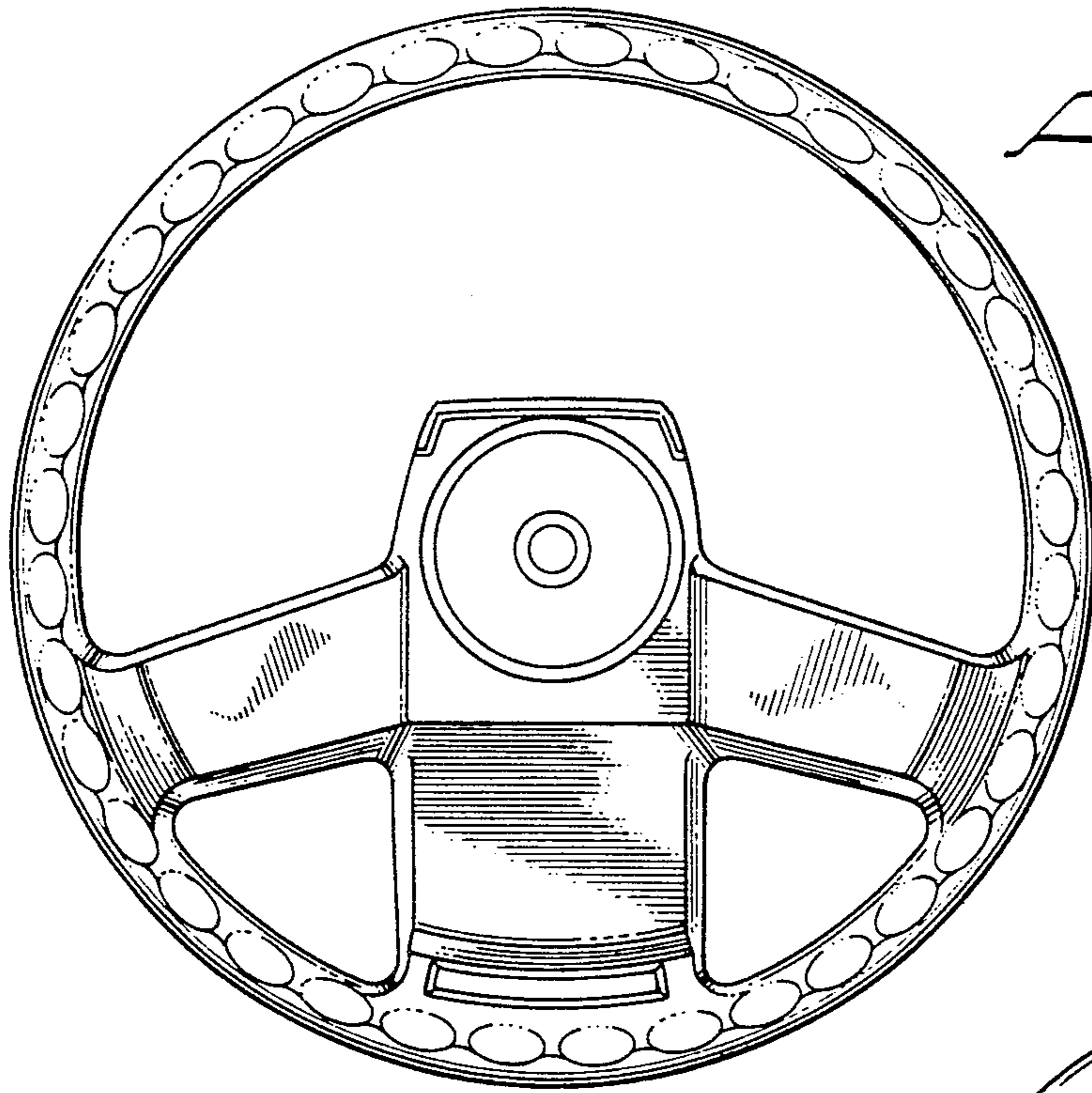

FIG. 4.

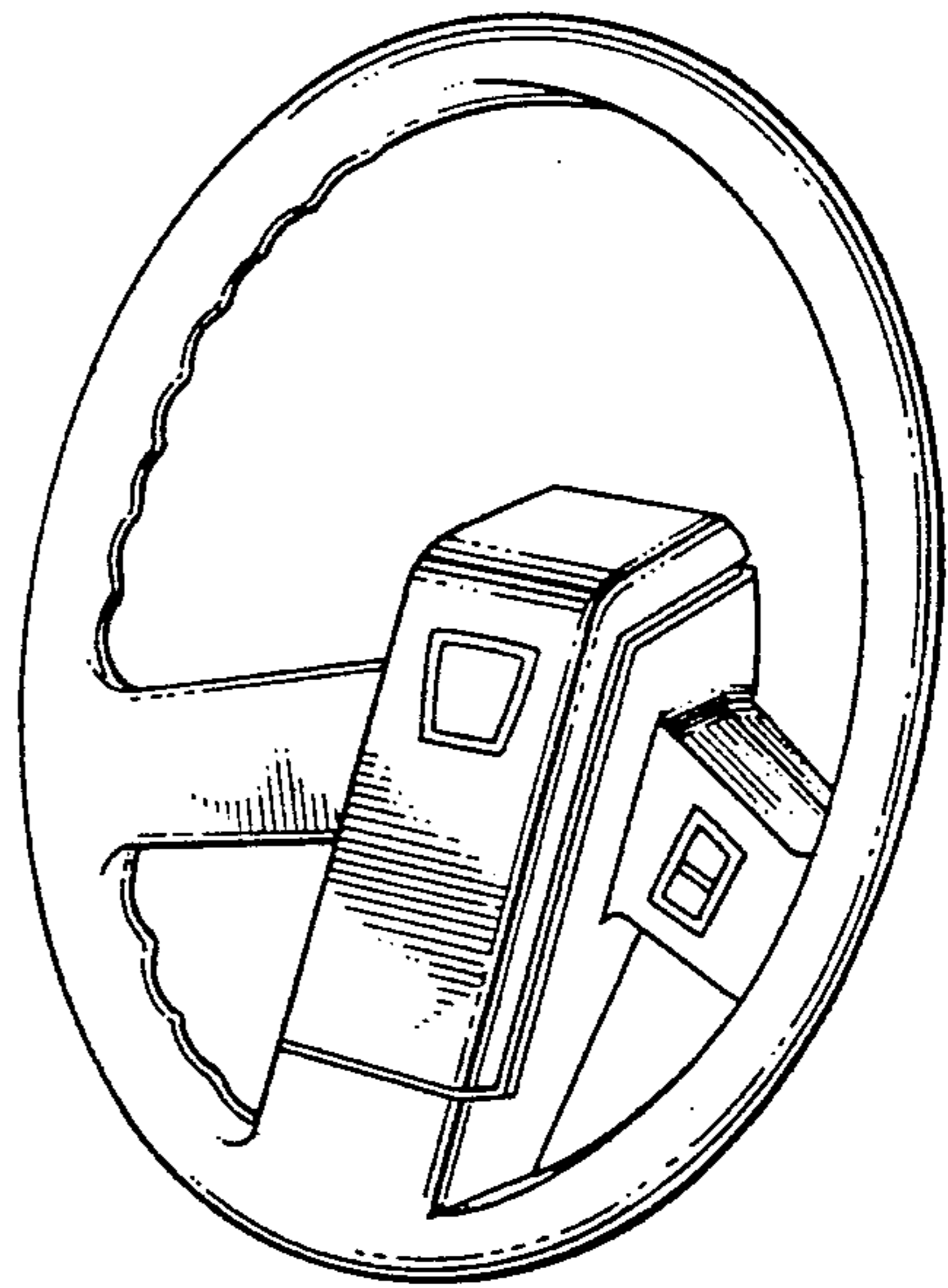

FIG. 6.

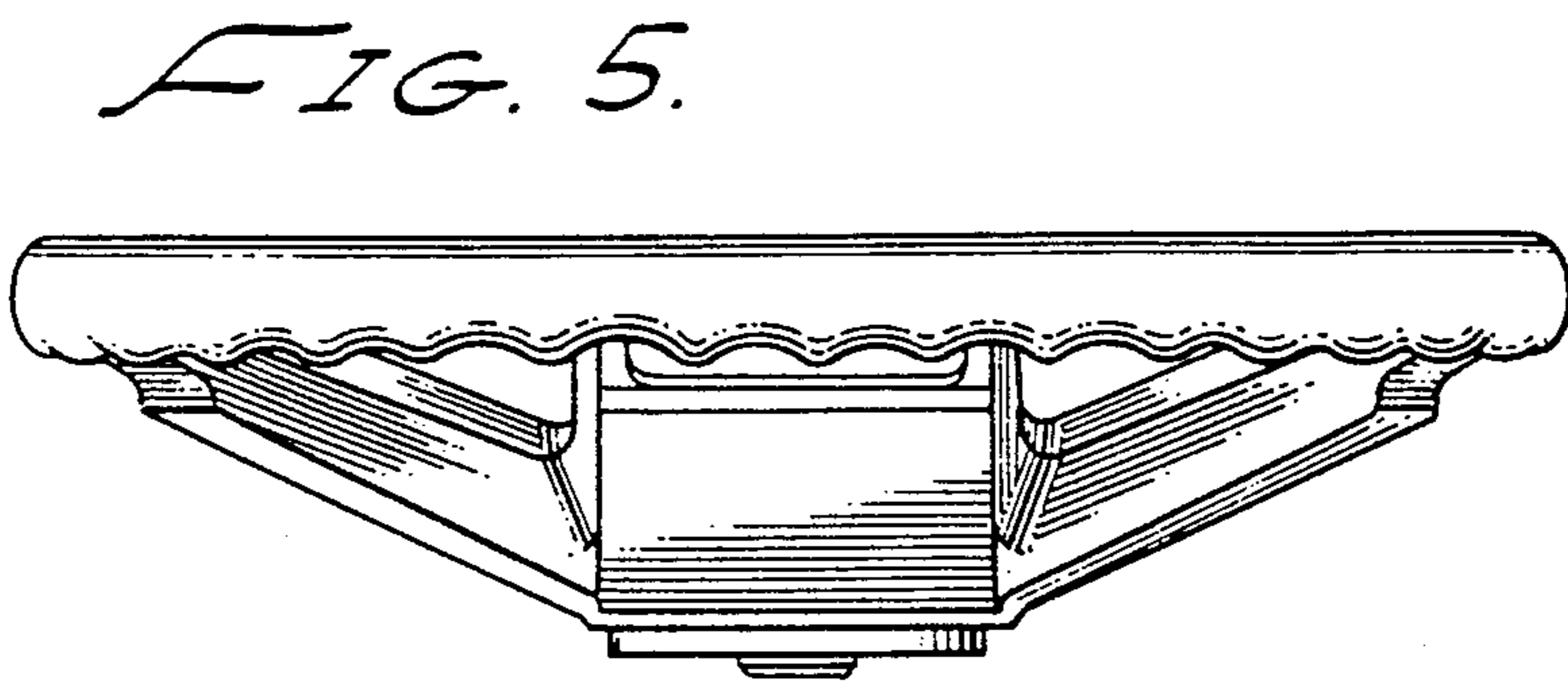

FIG. 5.