

[54] TABLE

[75] Inventor: Giovanni Offredi, Milan, Italy

[73] Assignee: Fratelli Saporiti Industria
Arredamenti di Saporiti Sergio e
Giorgio S.N.C., Besnate, Italy

[**] Term: 14 Years

[21] Appl. No.: 406,634

[22] Filed: Aug. 9, 1982

[52] U.S. Cl. D6/483

[58] Field of Search D6/175, 177, 179, 146

[56] References Cited

PUBLICATIONS

Interiors, May 1976, p. 56, Table No. 3000.

Primary Examiner—Bruce W. Dunkins

Attorney, Agent, or Firm—Kuhn, Muller and Bazerman

[57] CLAIM

The ornamental design for a table, as shown and described.

DESCRIPTION

FIG. 1 is a side perspective view illustrating a first embodiment of the table;

FIG. 2 is a front perspective view of the table of FIG. 1;

FIG. 3 is a front elevation of the table of FIG. 1;

FIG. 4 is a plan view of the table of FIG. 1;

FIG. 5 is a side elevation view of the table of FIG. 1;

FIG. 6 is a front perspective view illustrating a second embodiment of the table;

FIG. 7 is a side perspective of the table of FIG. 6;

FIG. 8 is a front elevation view of the table of FIG. 6;

FIG. 9 is a plan view of the table of FIG. 6;

FIG. 10 is a side elevation view of the table of FIG. 6; and

FIG. 11 is a perspective view of a third embodiment of the table.

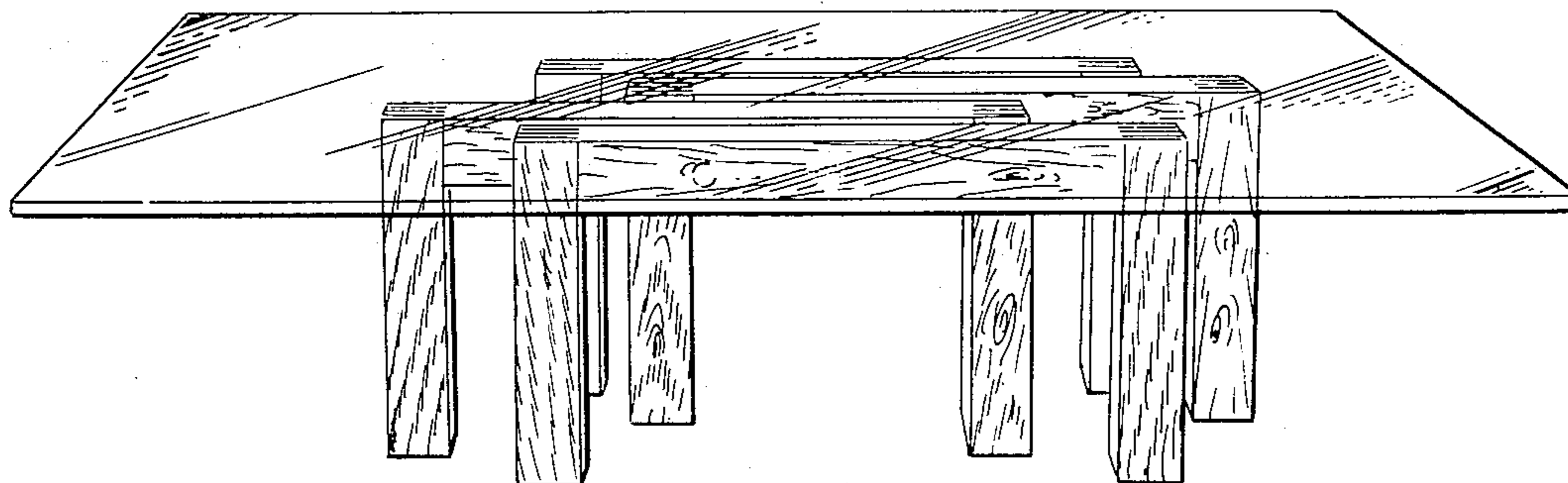

FIG. 1

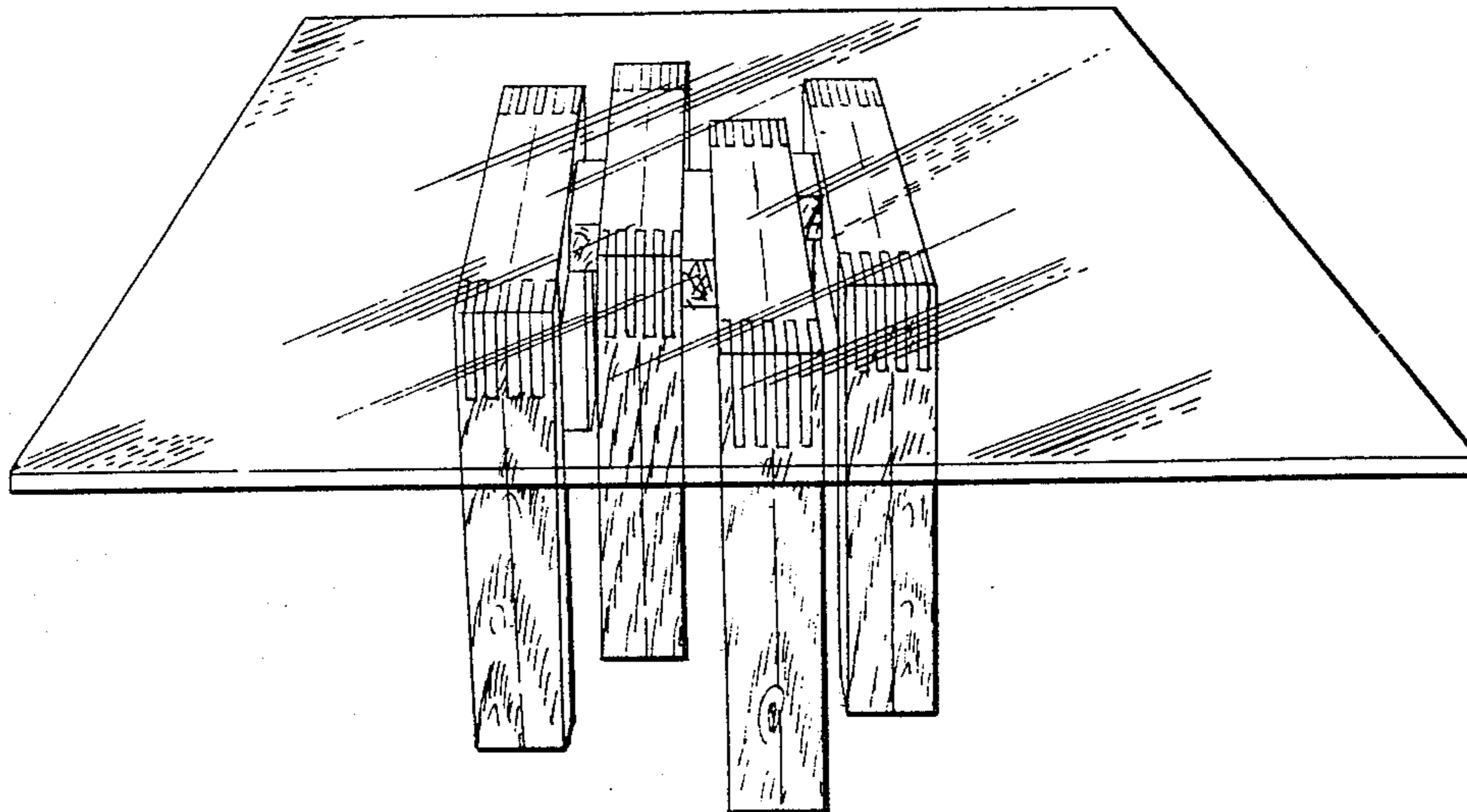

FIG. 2

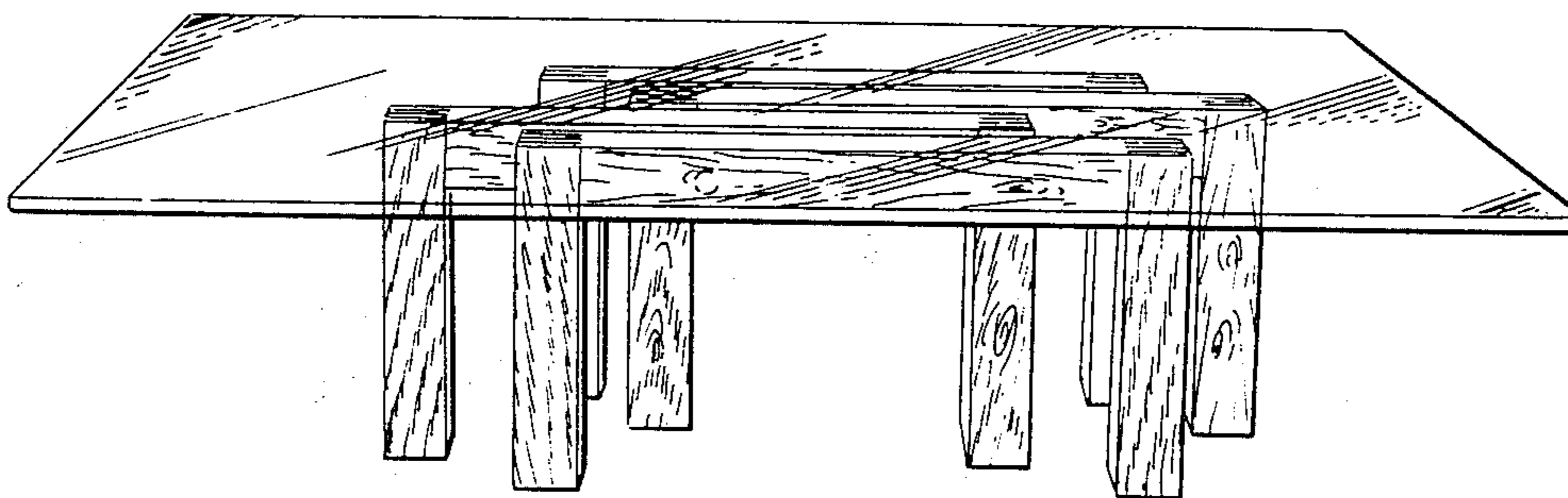

FIG. 5

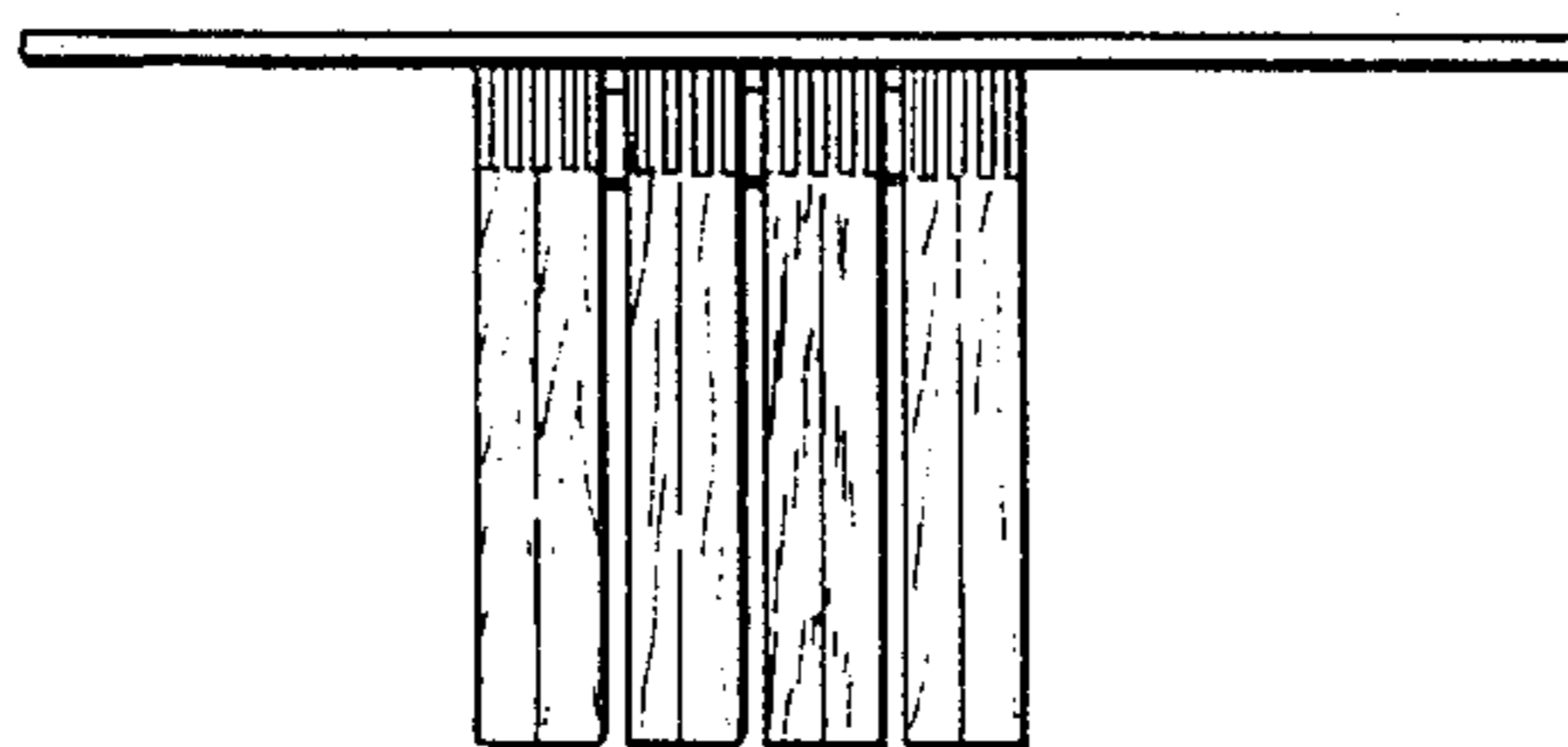

FIG. 11

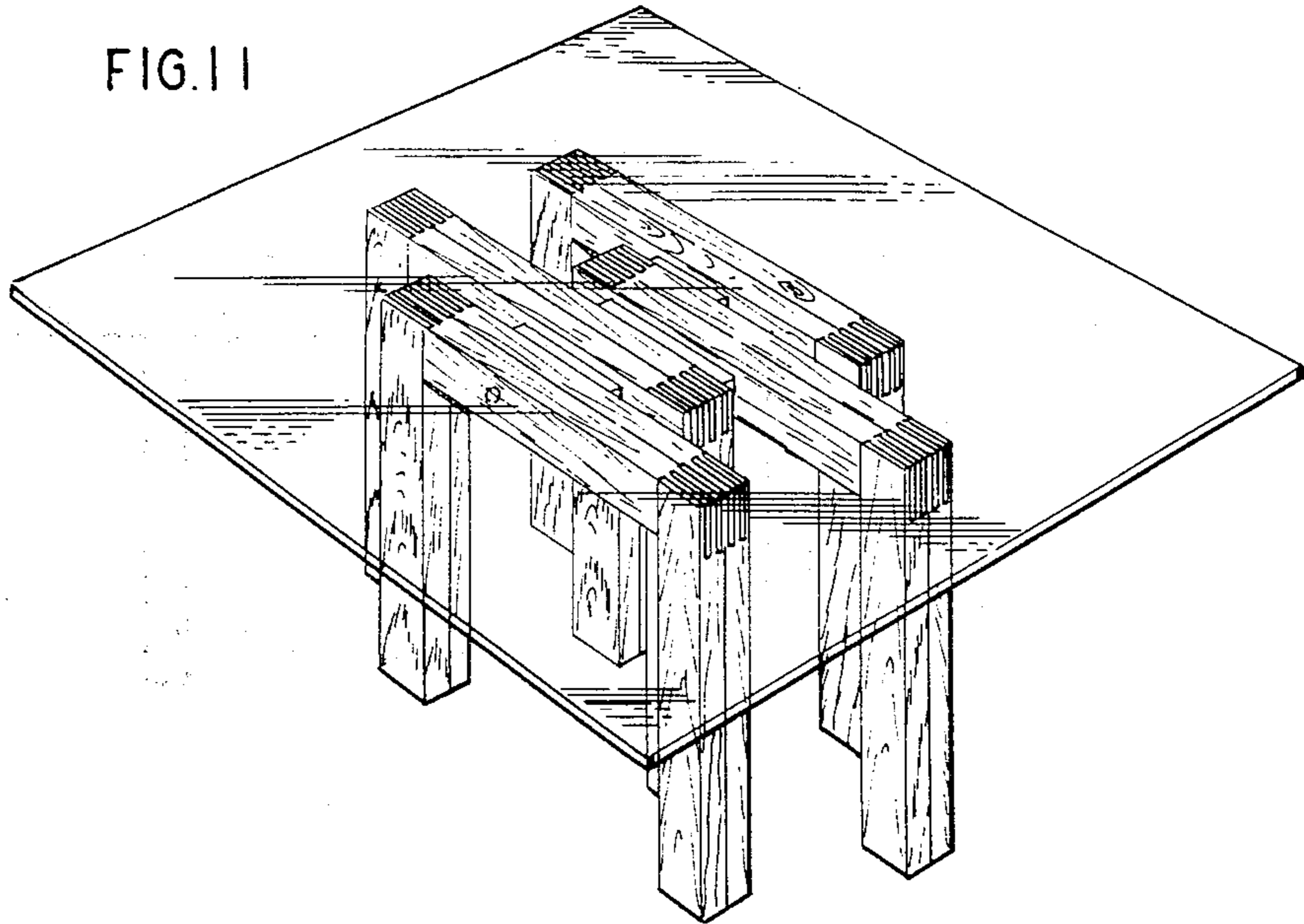

FIG. 3

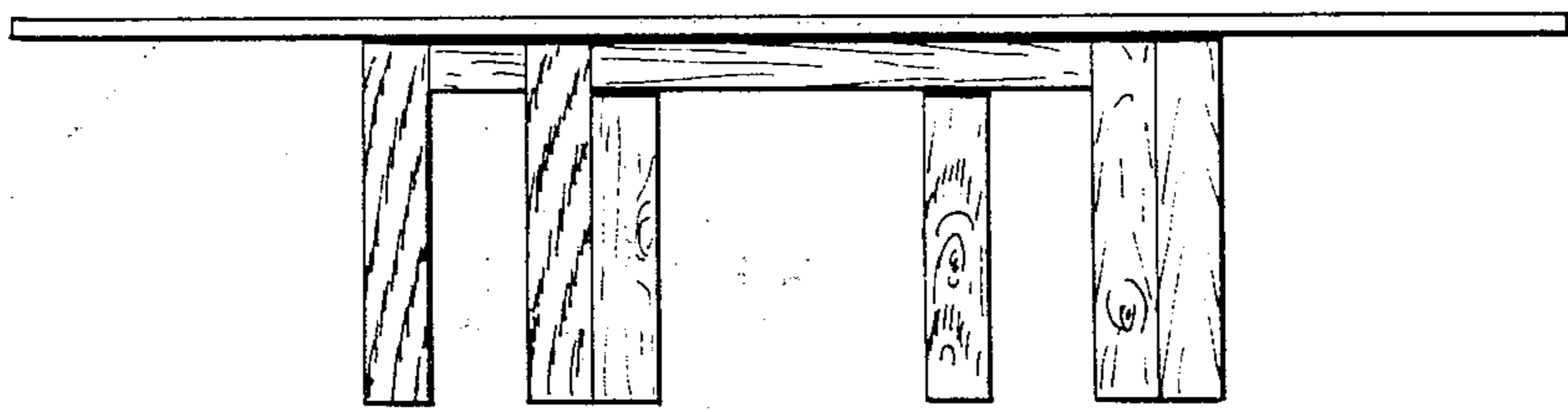

FIG. 4

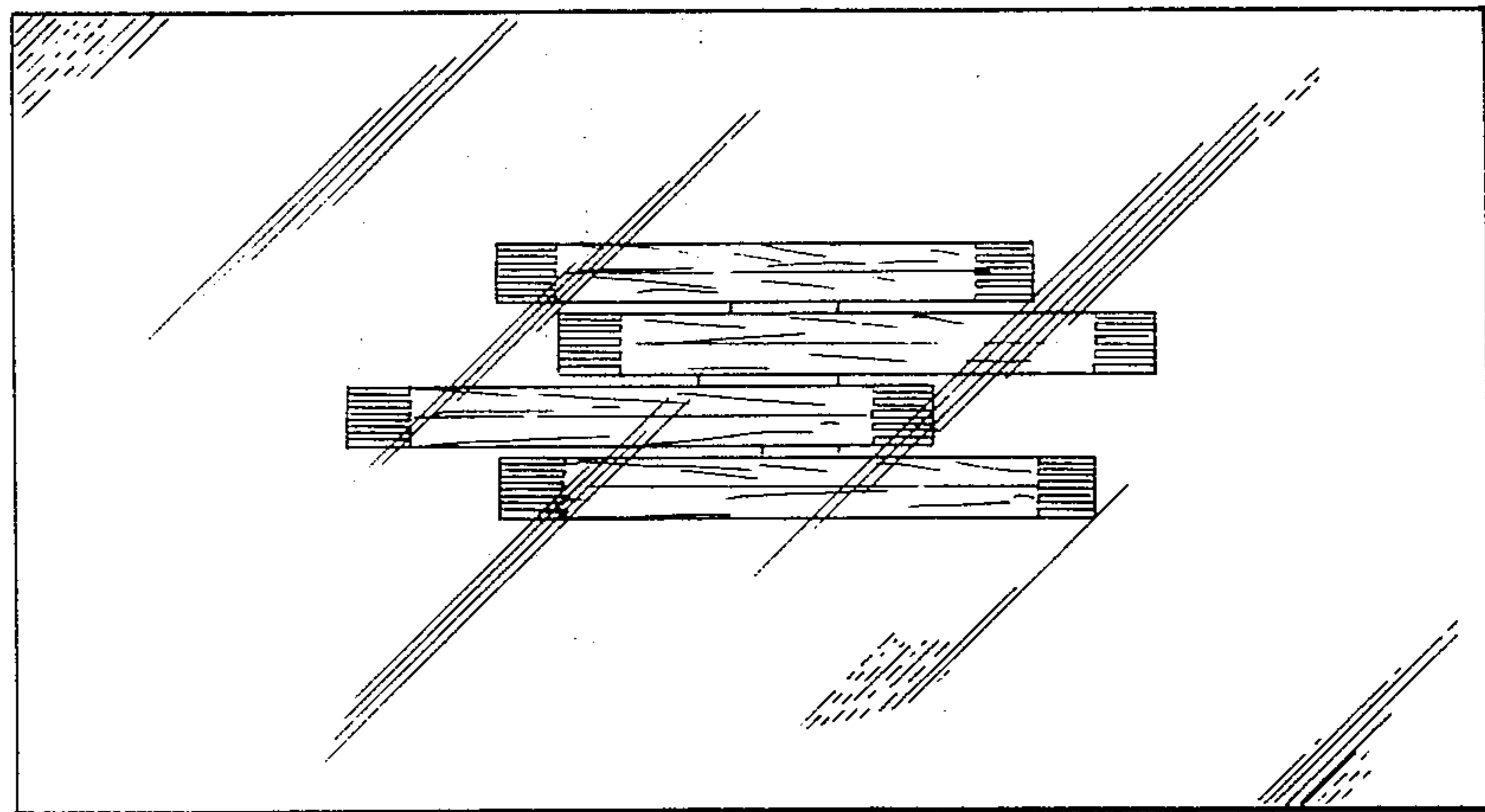

FIG. 6

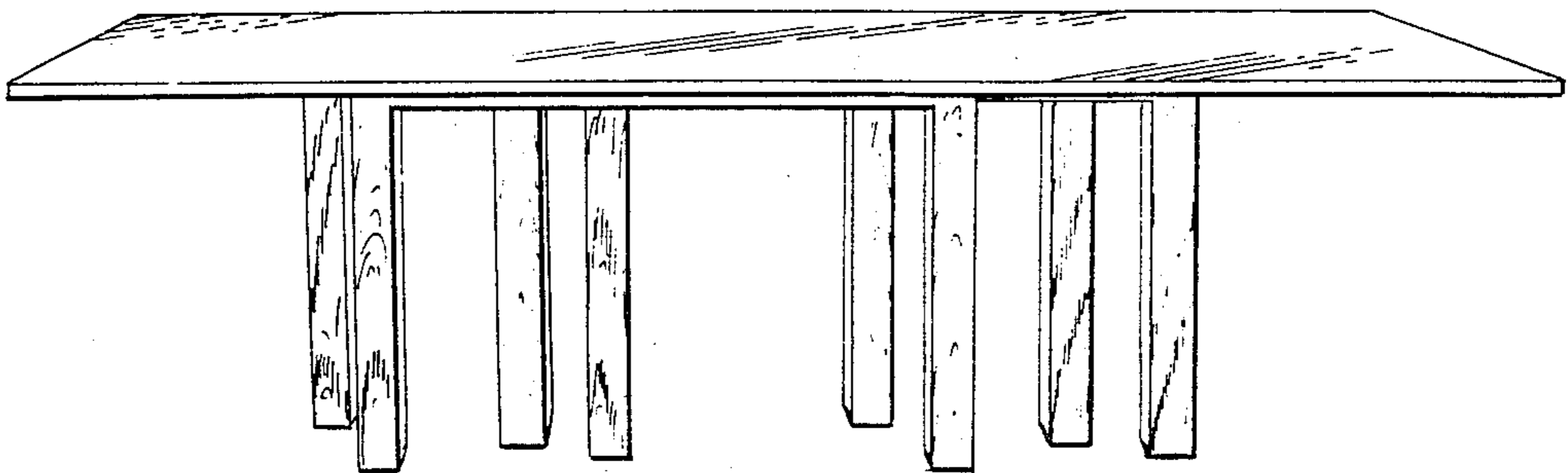

FIG. 7

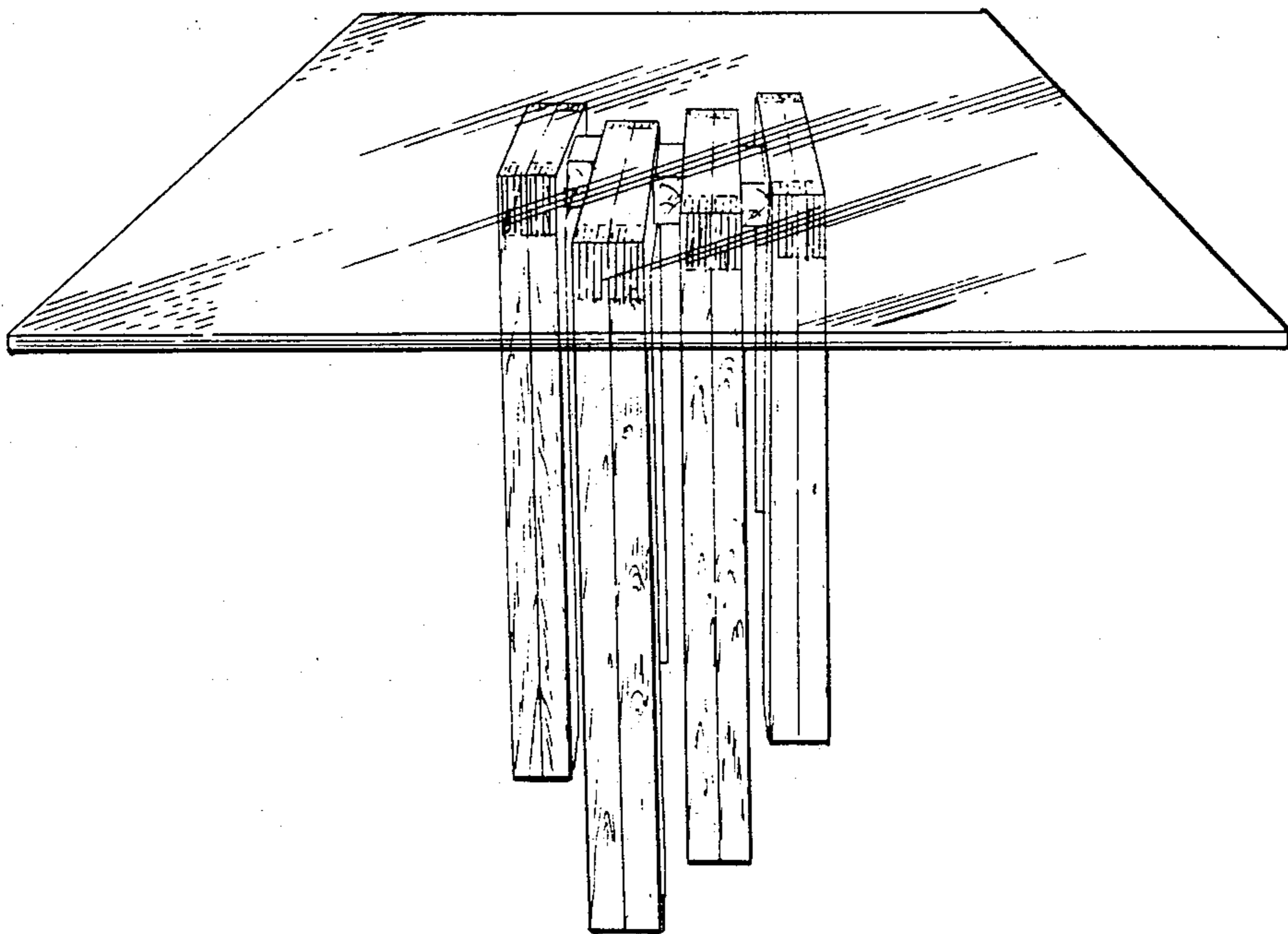

FIG. 8

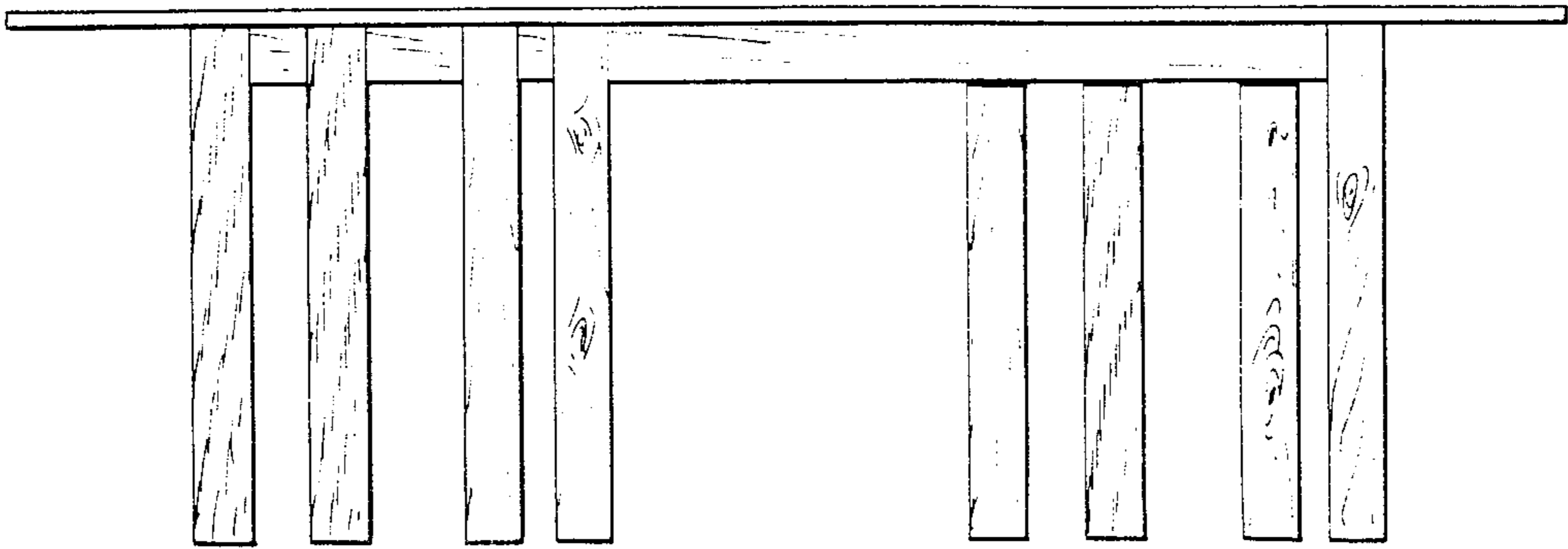

FIG. 9

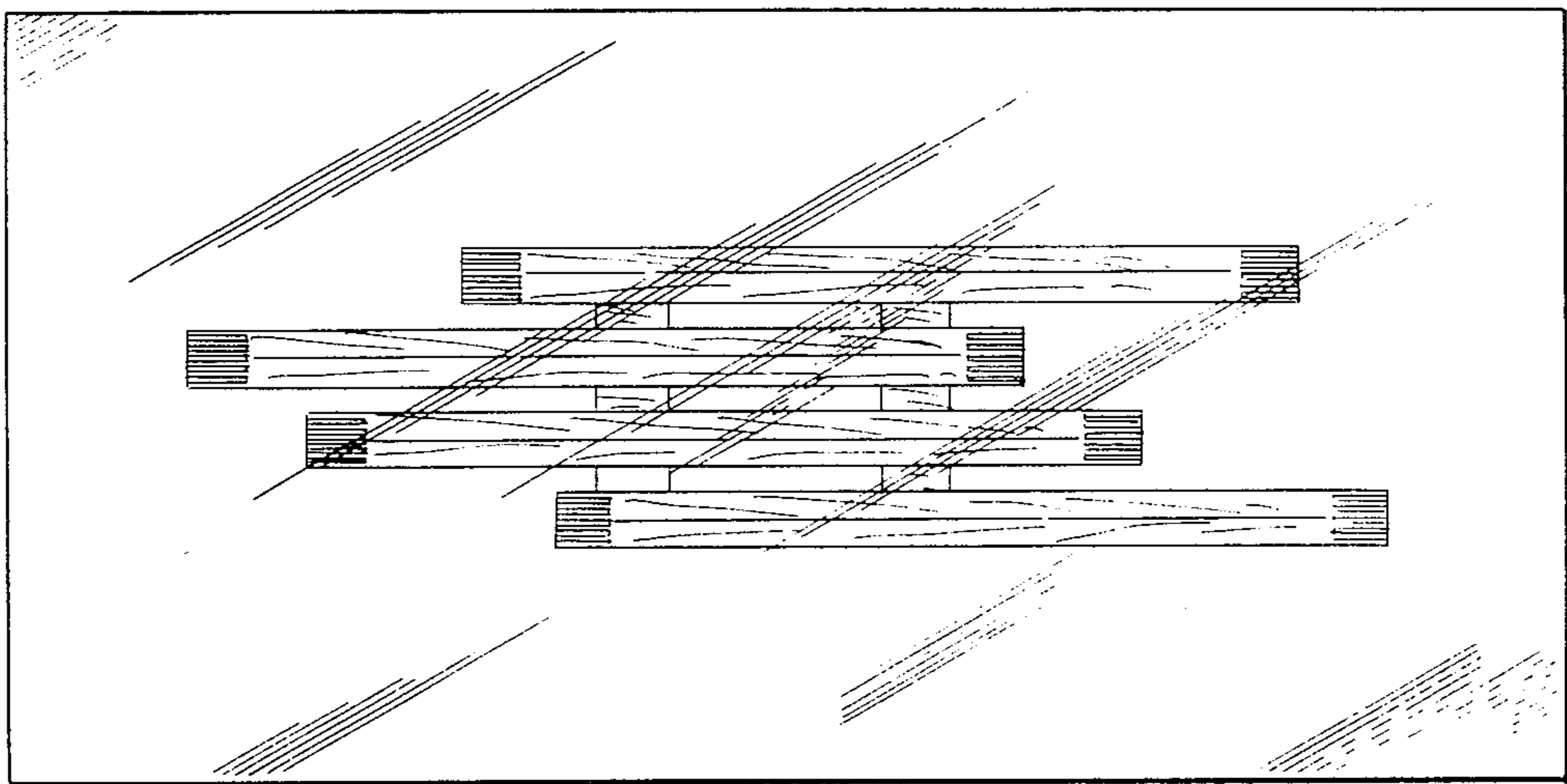

FIG. 10

