

[54] SEPARABLE HOLDER FOR KEYS AND THE LIKE

D. 270,821 10/1983 Fera D11/87
3,280,438 10/1966 Luketa 24/586

[75] Inventor: Luis Cuttler, Lomas Hipódromo, Mexico

FOREIGN PATENT DOCUMENTS

2358809 7/1976 France 24/3 K

[73] Assignee: Fabrica De Armazones Opticos, S.A., Mexico City, Mexico

Primary Examiner—George P. Word
Attorney, Agent, or Firm—Fulwider, Patton, Rieber, Lee & Utecht

[**] Term: 14 Years

[57] CLAIM

[21] Appl. No.: 428,120

The ornamental design for a separable holder for keys and the like, substantially as shown.

[22] Filed: Sep. 29, 1982

[52] U.S. Cl. D3/61; D11/81; D11/87

DESCRIPTION

[58] Field of Search D3/61-65; D11/48, 81, 87, 157; D21/104, 105, 107; 24/3 K, 586; 70/456 R, 459

FIG. 1 is a front perspective view of a separable holder for keys and the like showing my new design; FIG. 2 is a front elevational view thereof; FIG. 3 is a side elevational view thereof, from the left side of FIG. 2; FIG. 4 is a side elevational view thereof, from the right side of FIG. 2; FIG. 5 is a rear elevational view thereof; FIG. 6 is a top plan view thereof; and FIG. 7 is a bottom plan view thereof.

[56] References Cited

U.S. PATENT DOCUMENTS

D. 221,118 7/1971 Chambers D3/61
D. 256,963 9/1980 Herman D3/65
D. 268,553 4/1983 Beier D3/61

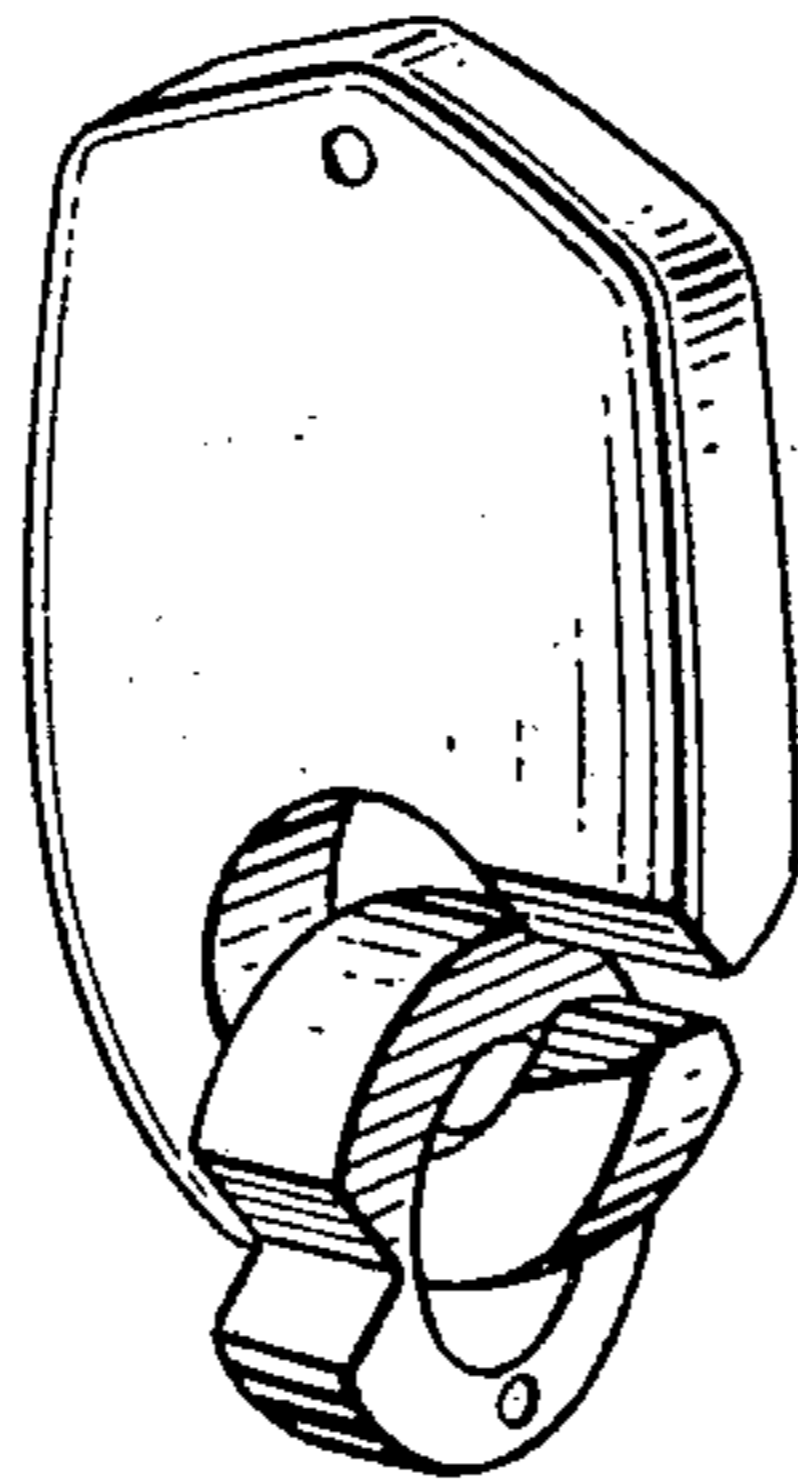

FIG. 1

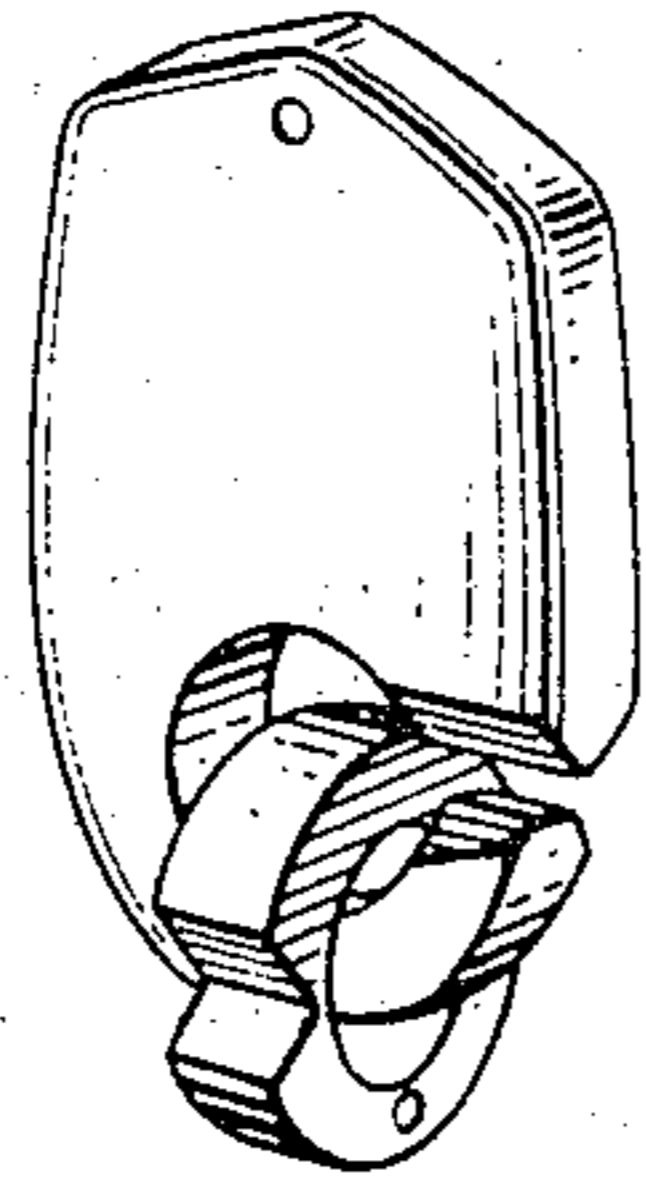

FIG. 2

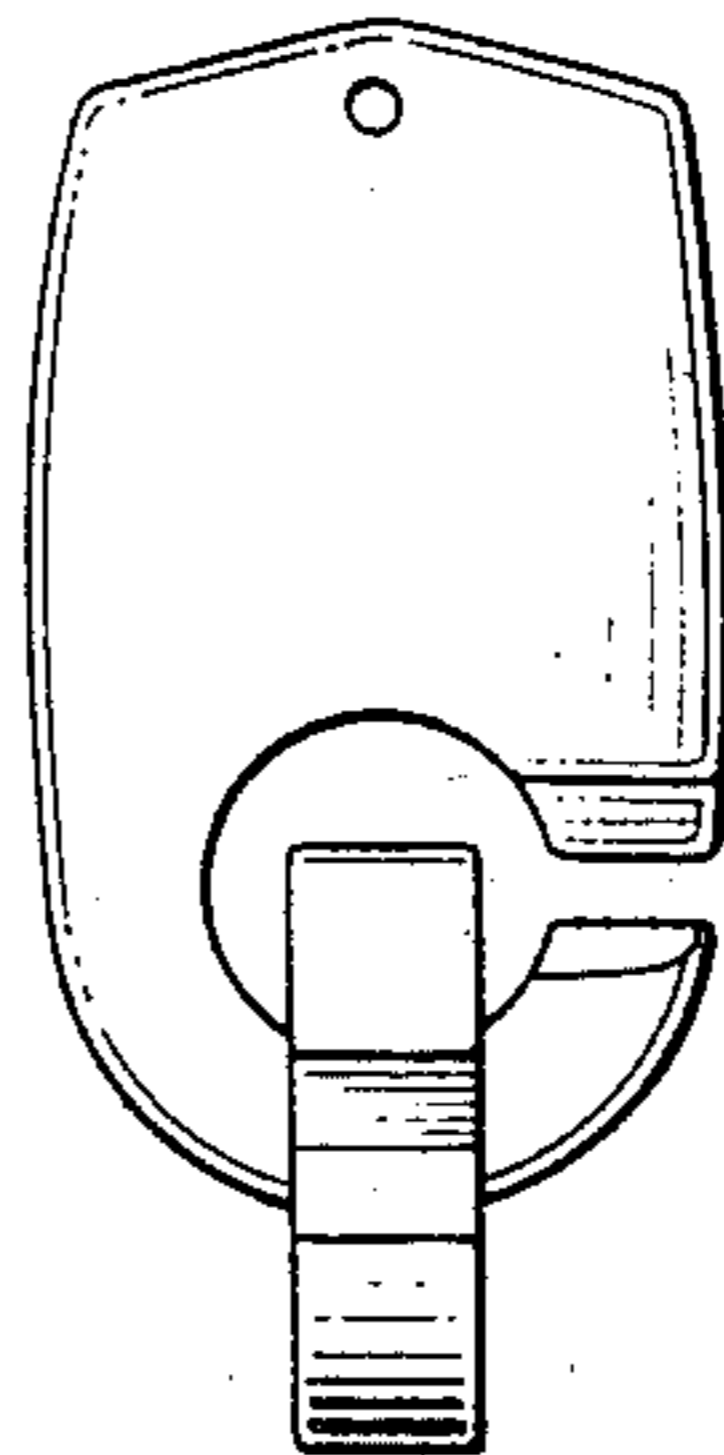

FIG. 3

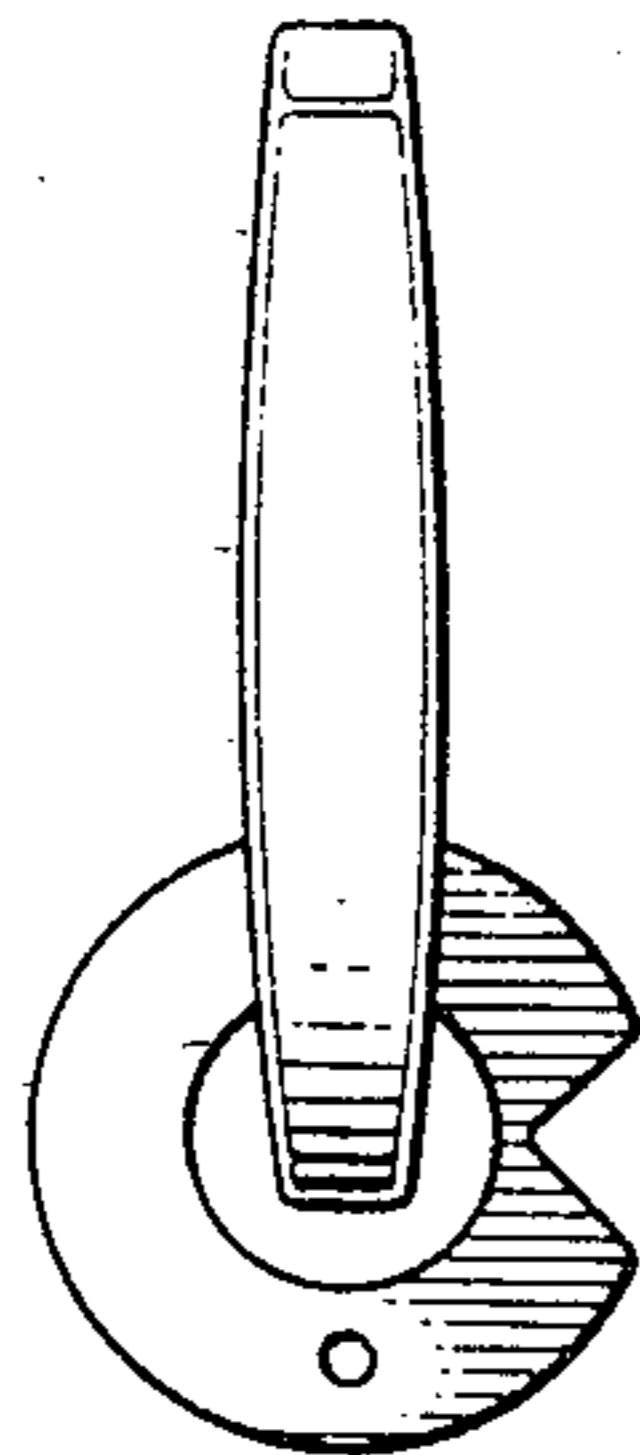

FIG. 4

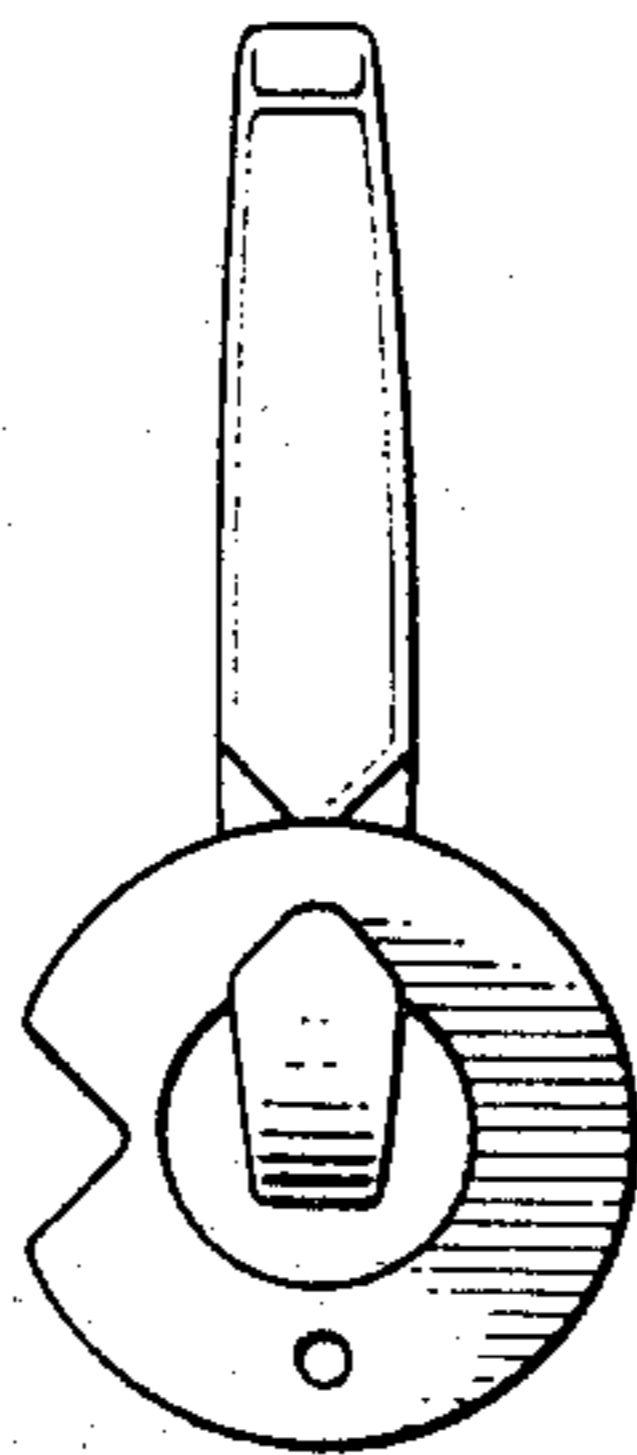

FIG. 5

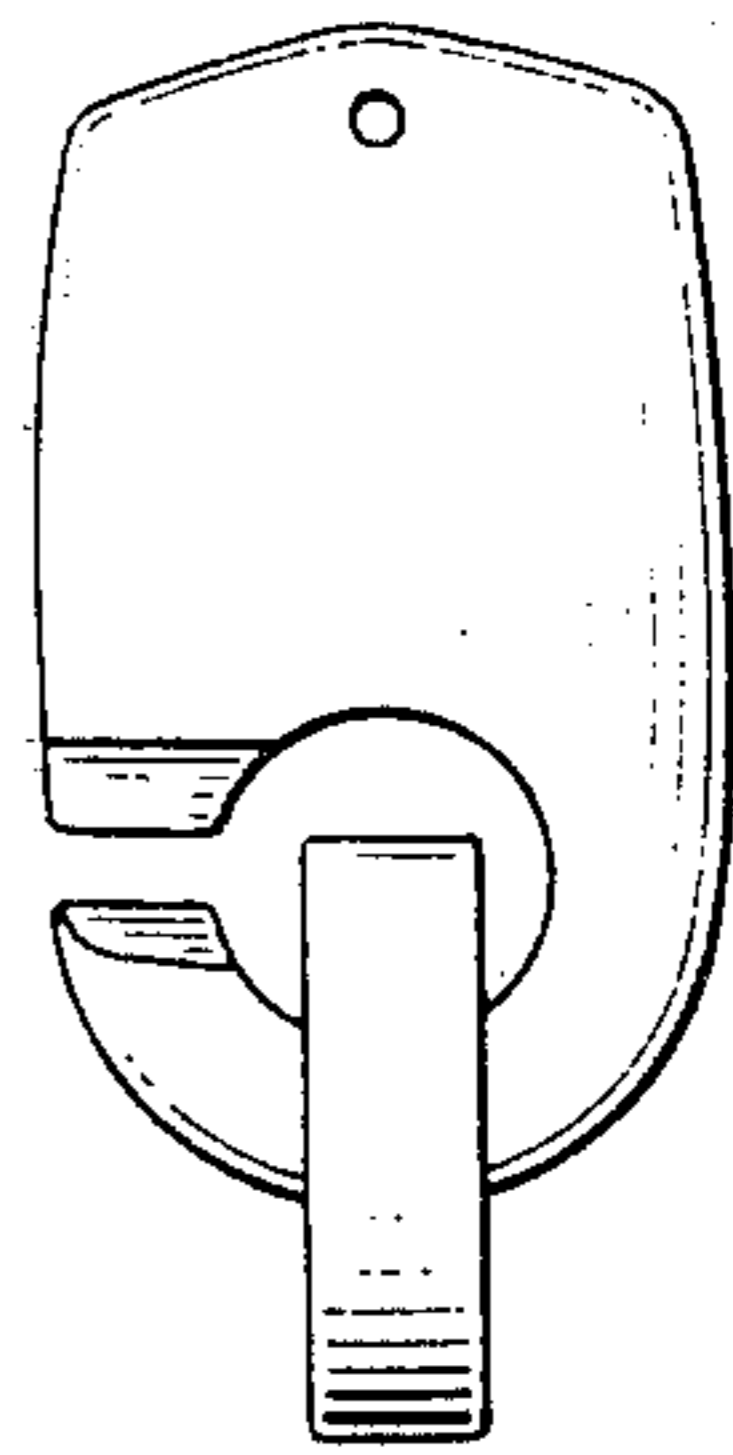

FIG. 6

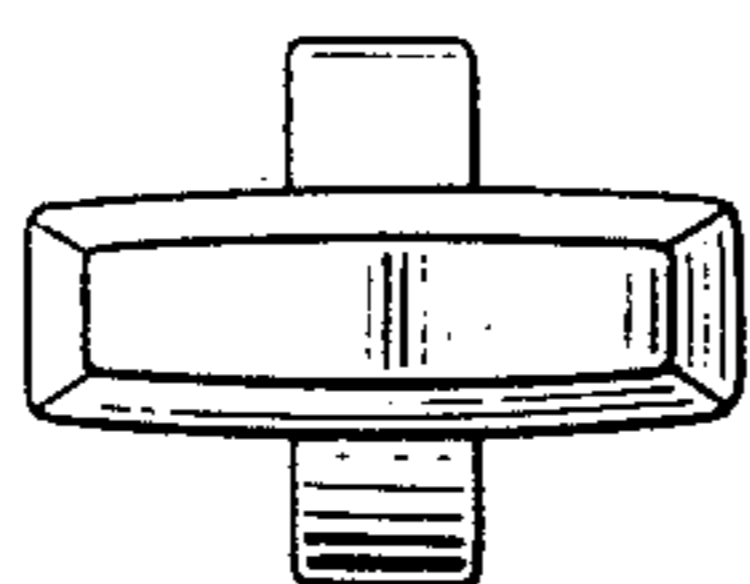

FIG. 7

