

[54] BATHTUB

[76] Inventor: Phillip D. Daniels, 4797 Lake Bluff, West Bloomfield Township, Mich. 38033

[\*\*] Term: 14 Years

[21] Appl. No.: 447,952

[22] Filed: Dec. 8, 1982

[52] U.S. Cl. .... D23/55

[58] Field of Search ..... D23/49, 50, 55, 56, D23/57, 69; D24/38; 4/538, 542-544, 571-579, 584, 589, 590, 592

[56] References Cited

U.S. PATENT DOCUMENTS

D. 211,789	7/1968	Bonsock	.....	D23/55
D. 216,120	11/1969	Niemann et al.	.....	D23/55
D. 226,607	4/1973	Lawrence	.....	D23/55
D. 227,101	6/1973	Primault	.....	D23/55
D. 244,855	6/1977	Doman	.....	D23/55
D. 250,895	1/1979	Lavel	.....	D23/55

D. 253,008	9/1979	Guigues	.....	D23/55
D. 253,547	11/1979	Beddome et al.	.....	D23/55

Primary Examiner—James R. Largen  
Attorney, Agent, or Firm—H. P. Settle

[57] CLAIM

The ornamental design for a bathtub, as shown and described.

DESCRIPTION

FIG. 1 is an elevational view taken from one side of a bathtub showing my new design, the opposite side being a mirror image of the side shown;

FIG. 2 is a top plan view thereof;

FIG. 3 is an elevational view taken from one end thereof;

FIG. 4 is an elevational view taken from the end opposite that shown in FIG. 3;

FIG. 5 is a bottom plan view thereof;

FIG. 6 is a cross-sectional view taken on line 6—6 of FIG. 2; and

FIG. 7 is a cross-sectional view taken on line 7—7 of FIG. 2.

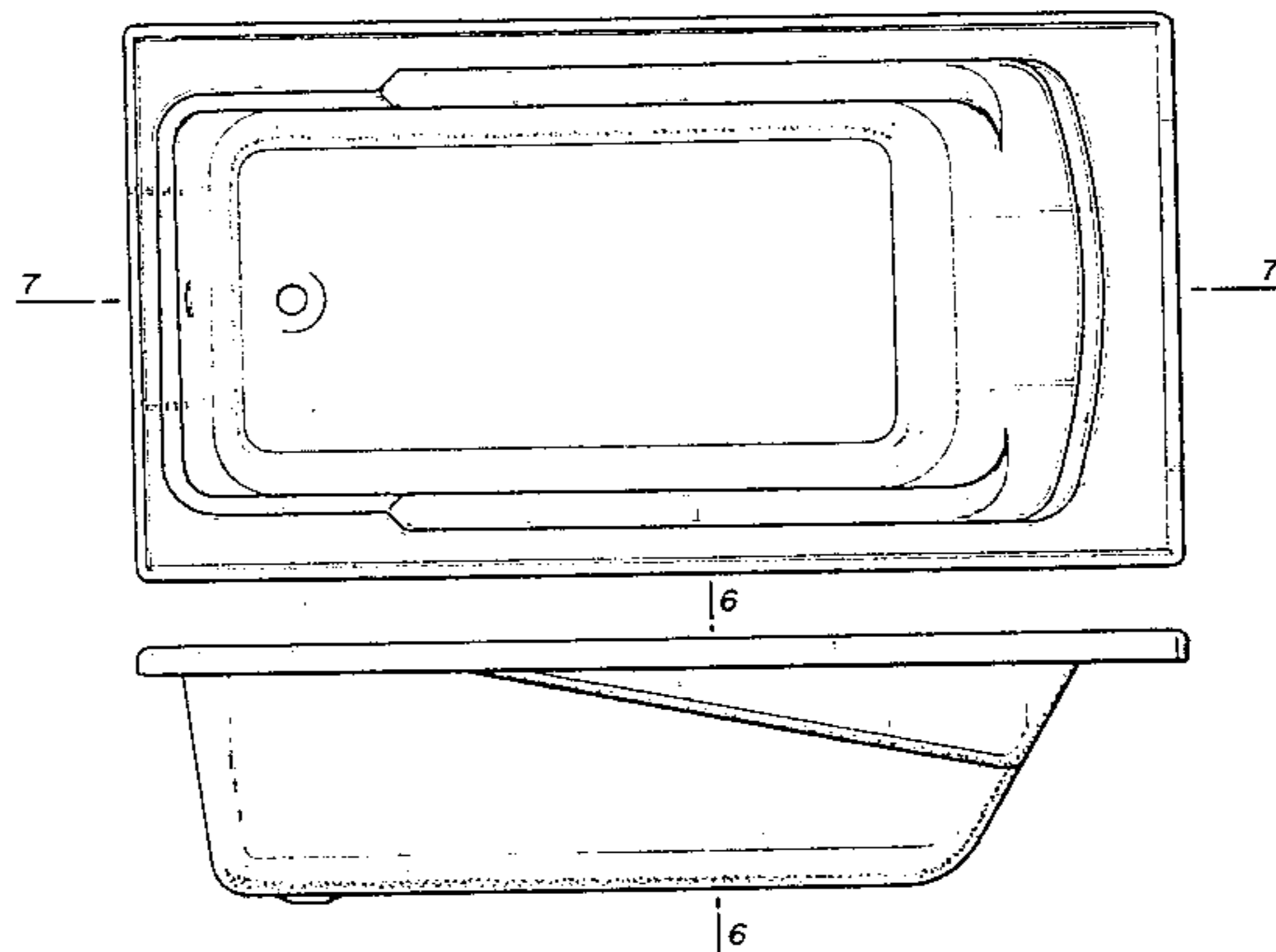

FIG. 2

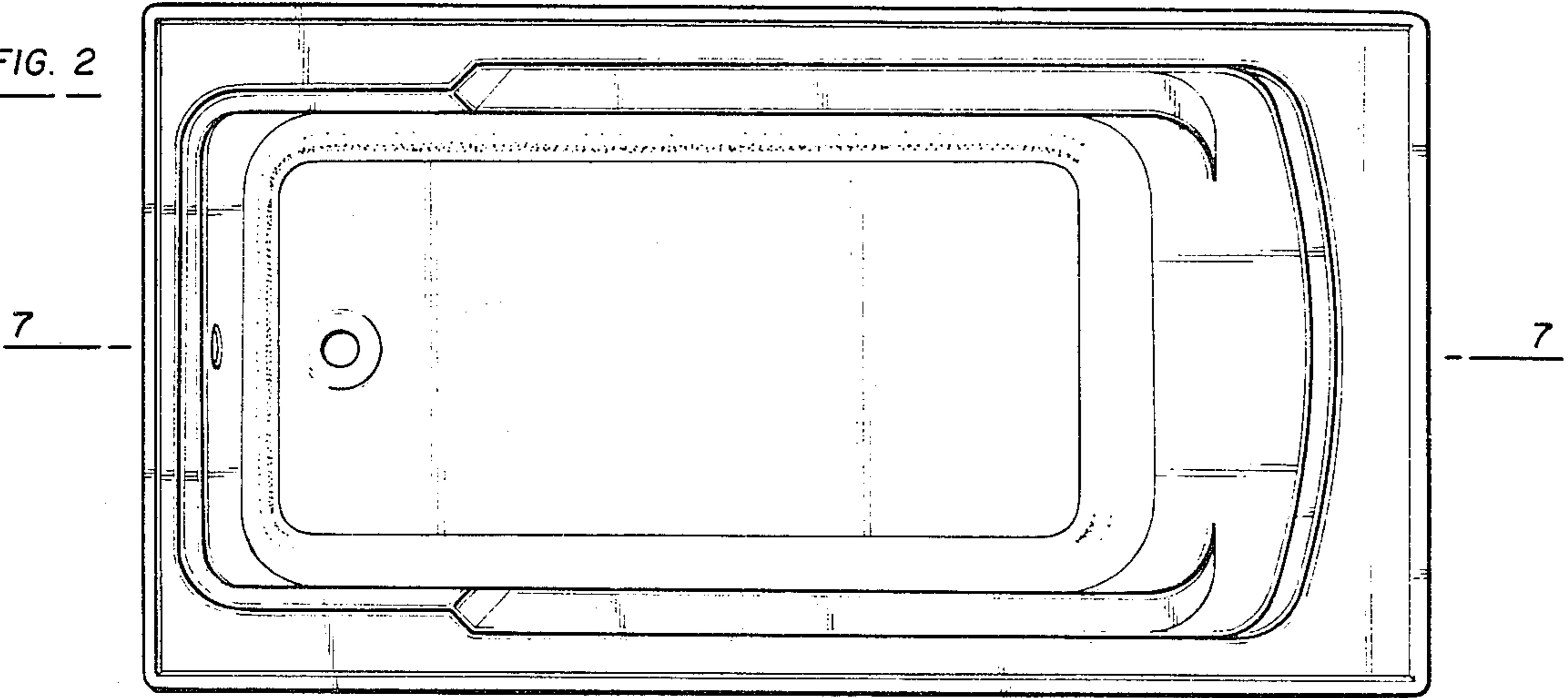

FIG. 1

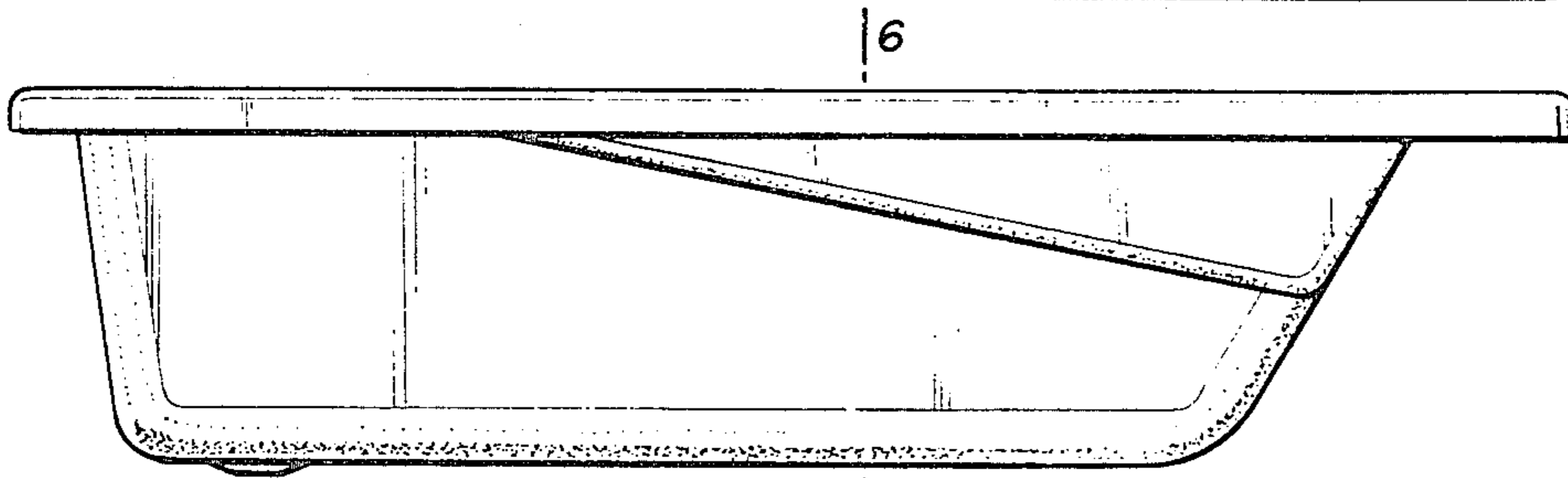

FIG. 3

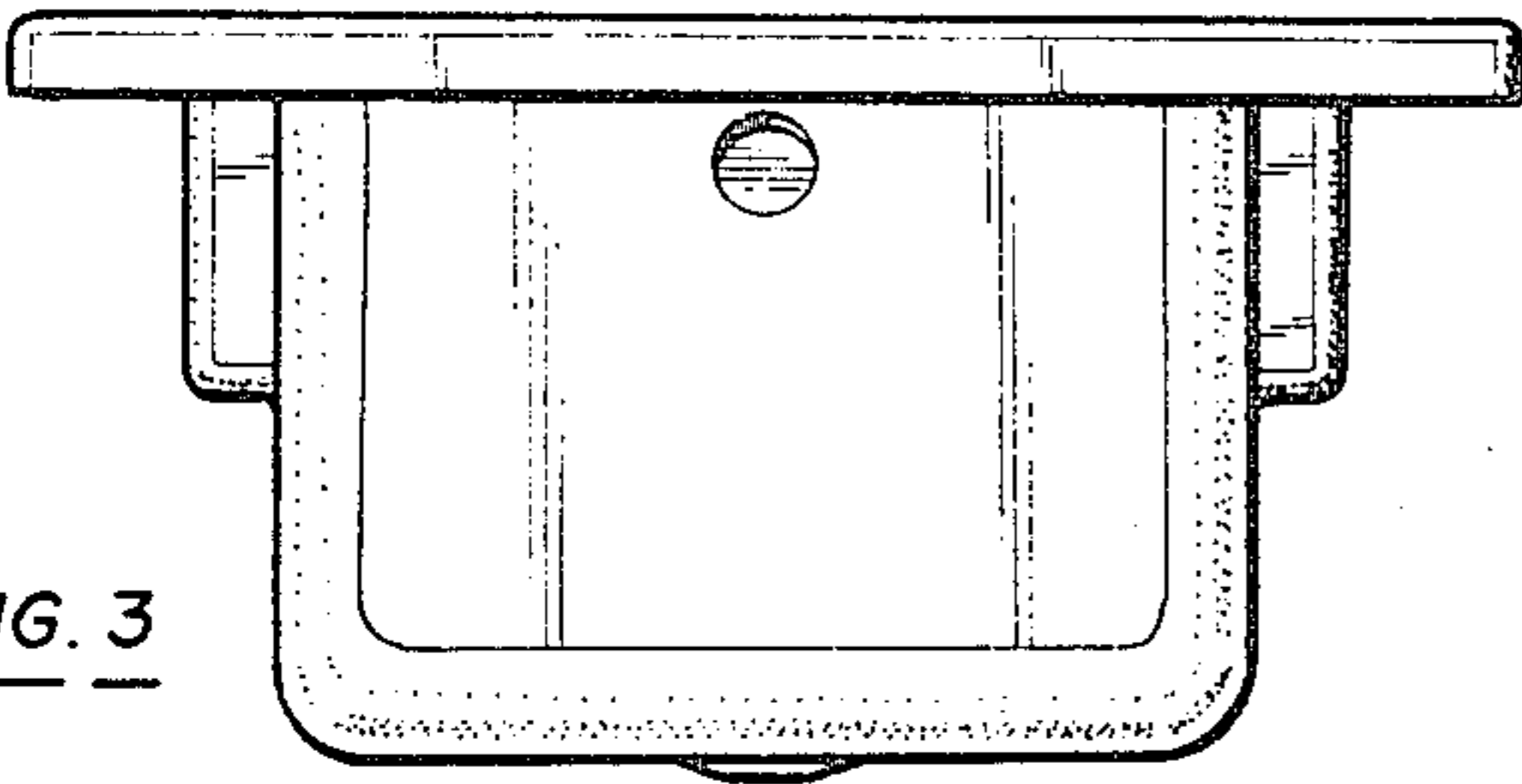

FIG. 4

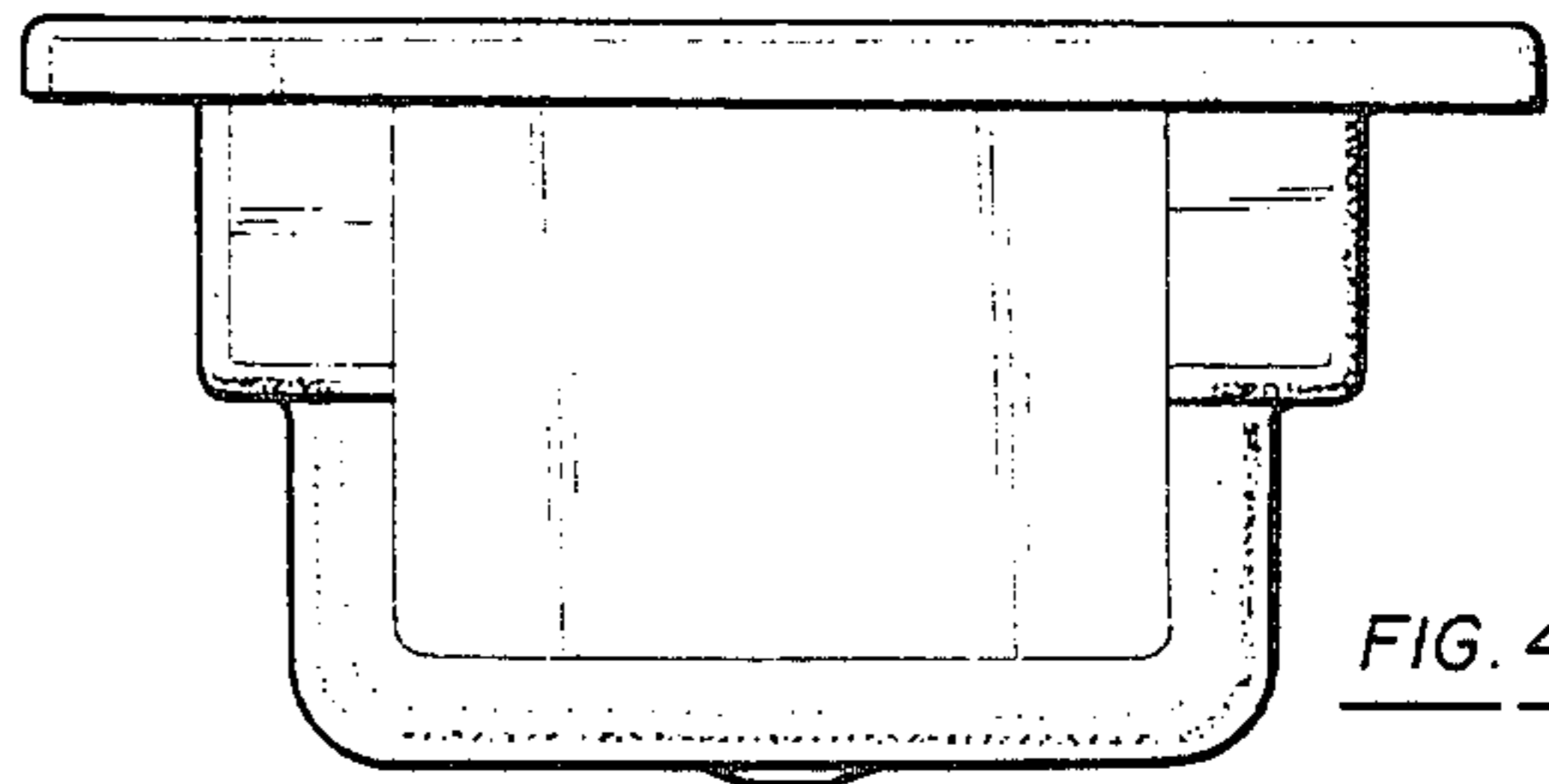
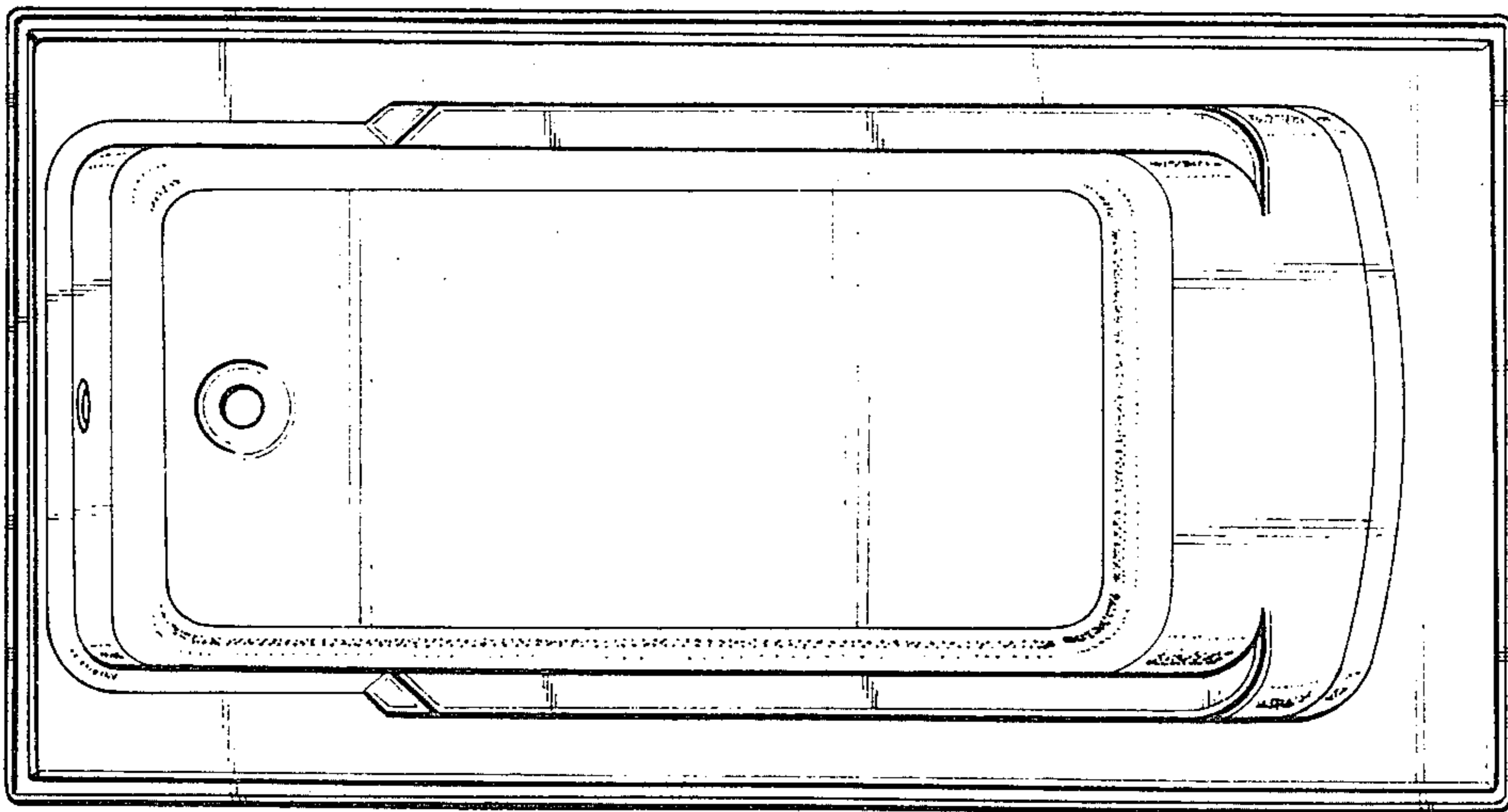

FIG. 5



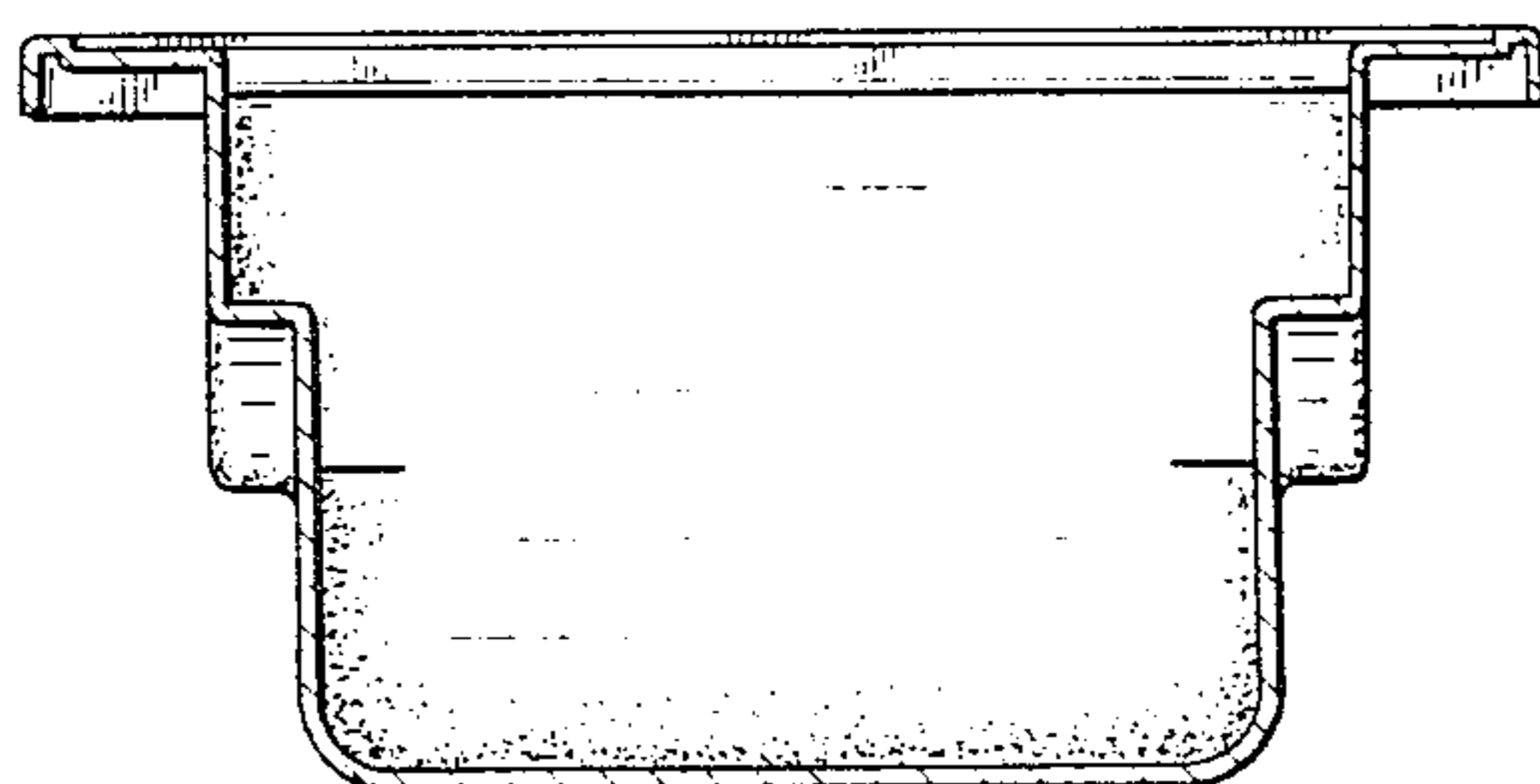

FIG. 6

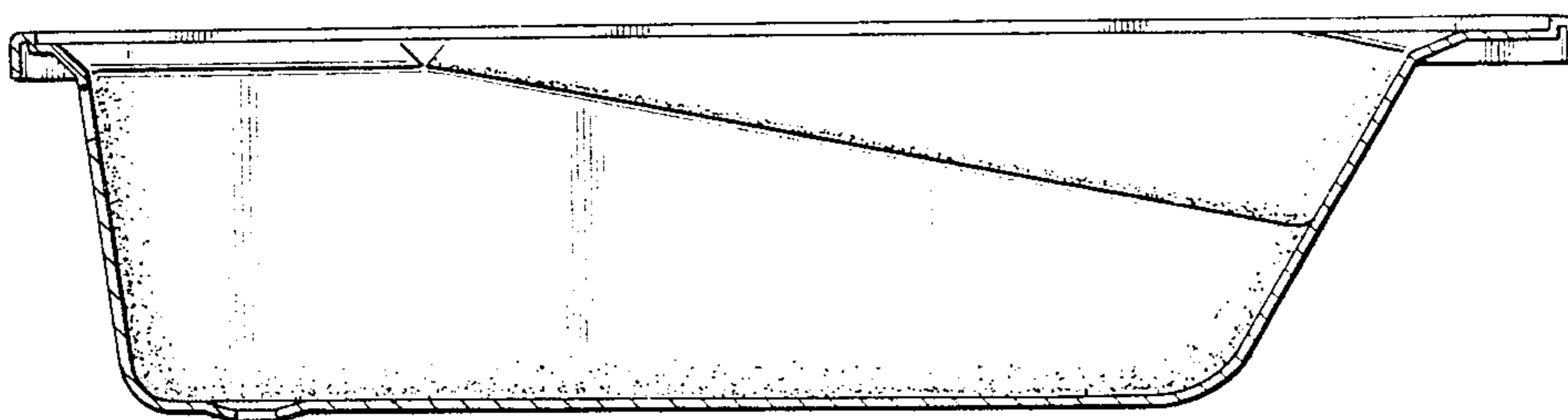

FIG. 7