

[54] SEAT

[76] Inventors: Seymour W. Golden, 620 Cooper St., Delanco, N.J. 08075; Robert N. Kehl, 6844 Souder St., Philadelphia, Pa. 19149

[**] Term: 14 Years

[21] Appl. No.: 372,452

[22] Filed: Apr. 27, 1982

[52] U.S. Cl. D6/373

[58] Field of Search D6/67-78, D6/31, 37, 38, 59, 62, 63

[56] References Cited

U.S. PATENT DOCUMENTS

- D. 226,747 4/1973 Koepke D6/69 X
- D. 237,847 12/1975 Sklaroff D6/69
- D. 265,955 8/1982 Raftery et al. D6/59 X

OTHER PUBLICATIONS

- Interiors, Aug. 1976, p. 22, Chair bottom center by Turner Ltd.
- Medallion Brochure, Apr. 15, 1980, front cover, Chair No. 1273.
- Cosco Catalog, Jun. 3, 1974, Armchair upper left.

Primary Examiner—Bruce W. Dunkins
Attorney, Agent, or Firm—Lane, Aitken & Kananen

[57] CLAIM

The ornamental design for a seat, as shown and described.

DESCRIPTION

FIG. 1 is a front elevational view of a seat showing our new design in the form of a chair;
 FIG. 2 is a rear elevational view;
 FIG. 3 is a view in side elevation of the seat shown in FIG. 1;
 FIG. 4 is a top plan view of the seat shown in FIG. 1; and
 FIG. 5 is a bottom plan view thereof;
 FIG. 6 is a front elevational view of the design of FIG. 1 shown in the form of a settee;
 FIG. 7 is a rear elevational view;
 FIG. 8 is a side elevational view;
 FIG. 9 is a top plan view; and
 FIG. 10 is a bottom plan view thereof;
 FIG. 11 is a front elevational view of the design of FIG. 1 shown in the form of a sofa;
 FIG. 12 is a rear elevational view;
 FIG. 13 is a side elevational view;
 FIG. 14 is a top plan view; and
 FIG. 15 is a bottom plan view thereof.
 The sides of the seat forms not shown are substantially mirror images of the respective sides shown in FIGS. 3, 8 and 13.

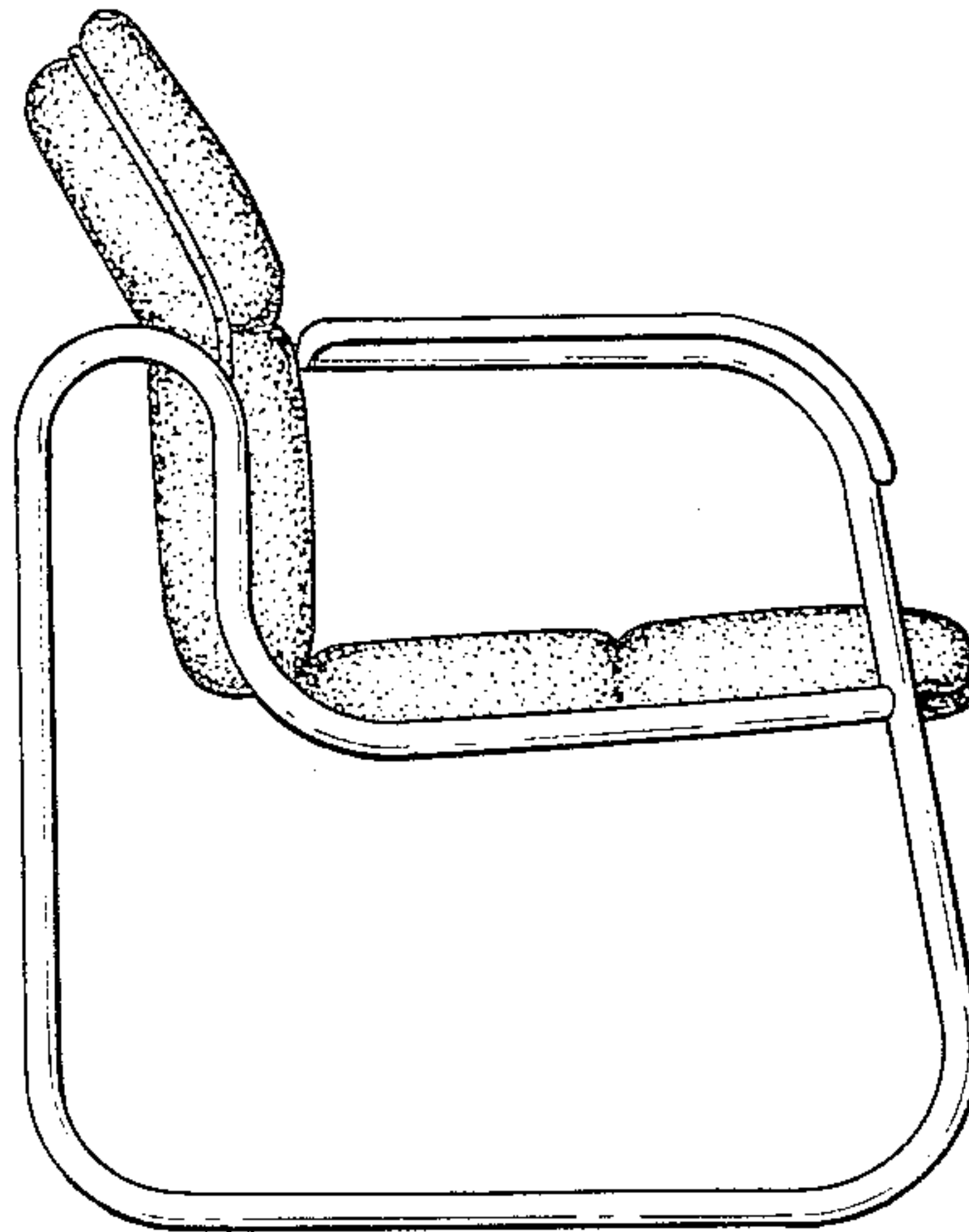

FIG. 1.

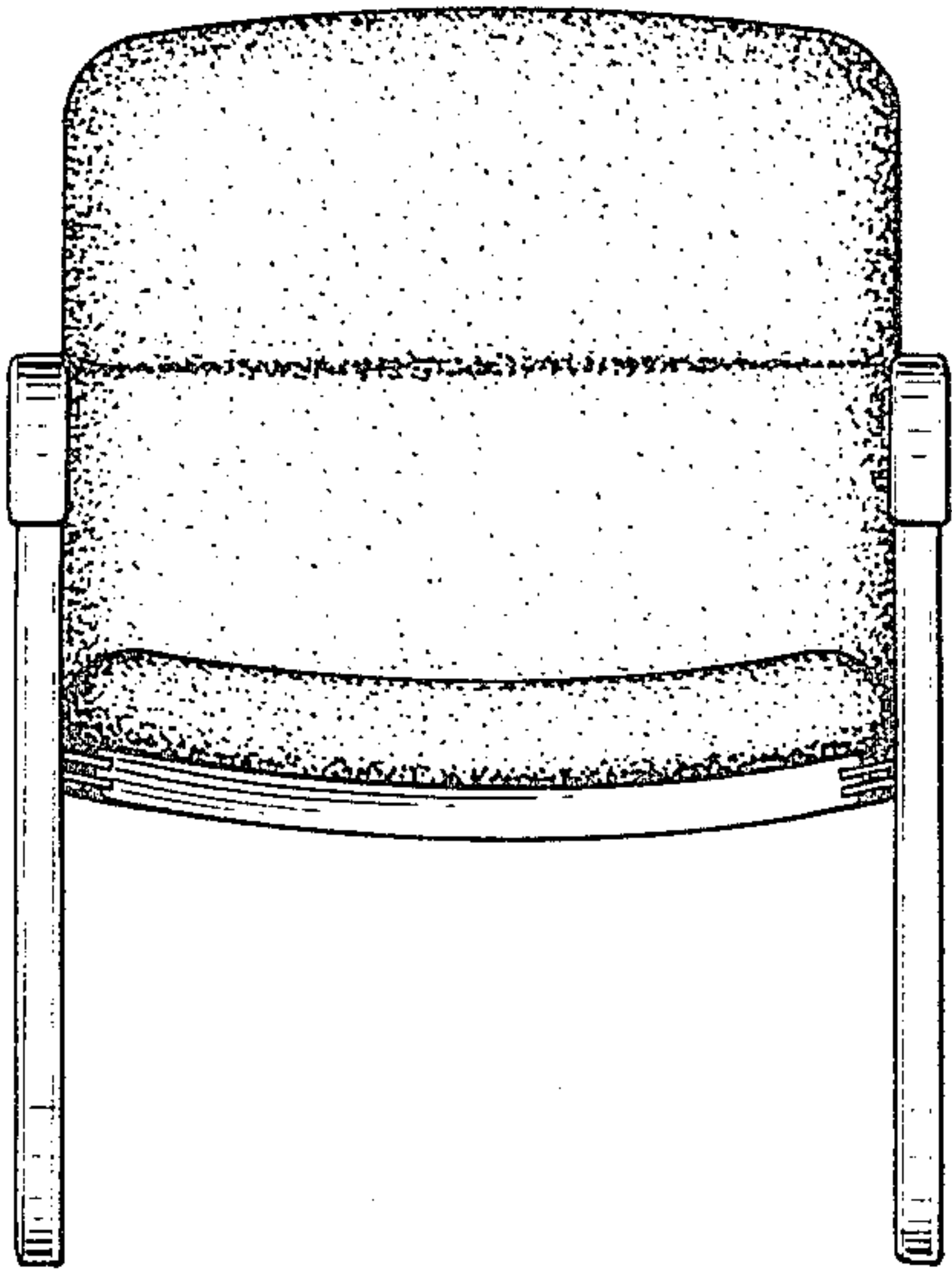

FIG. 2.

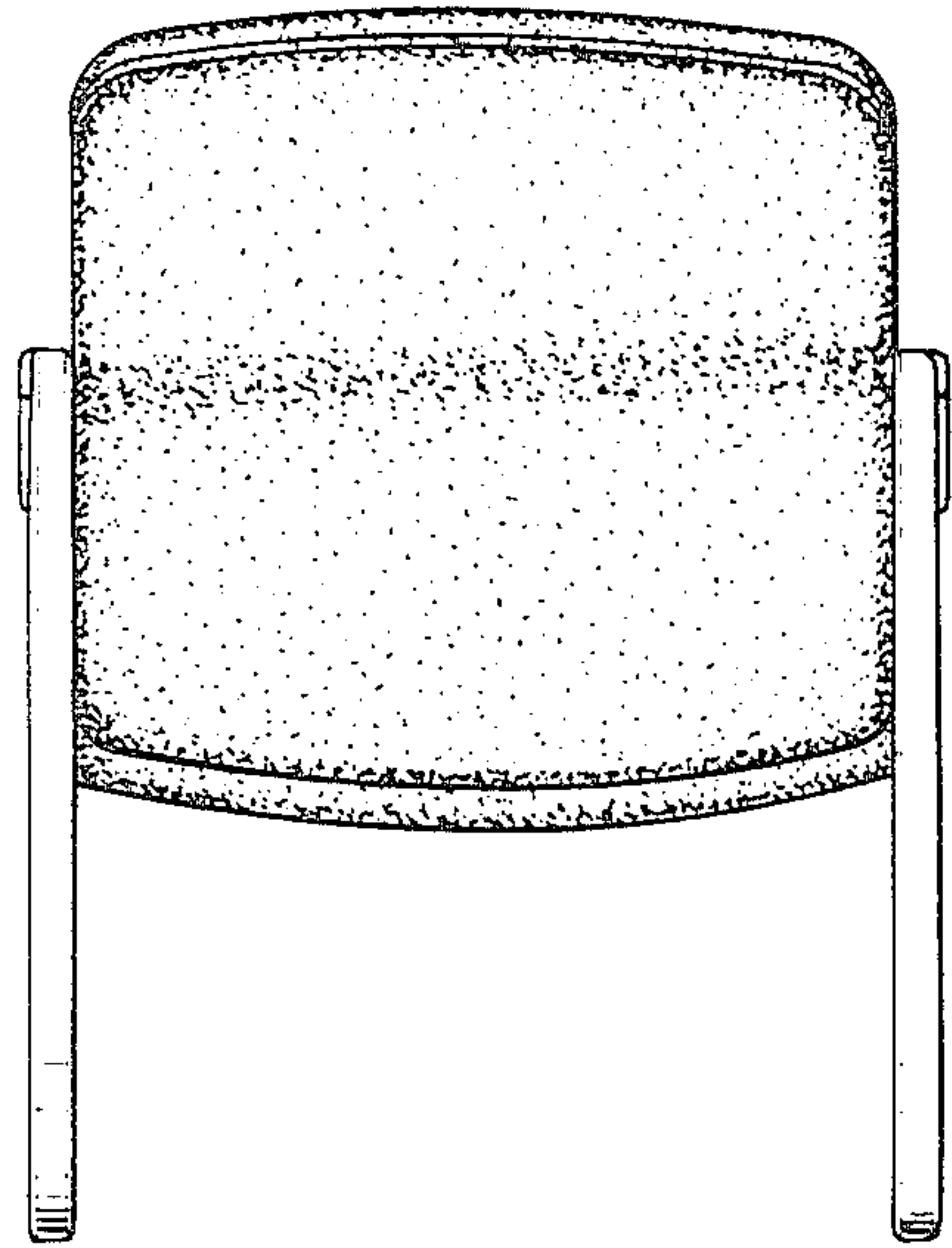

FIG. 3.

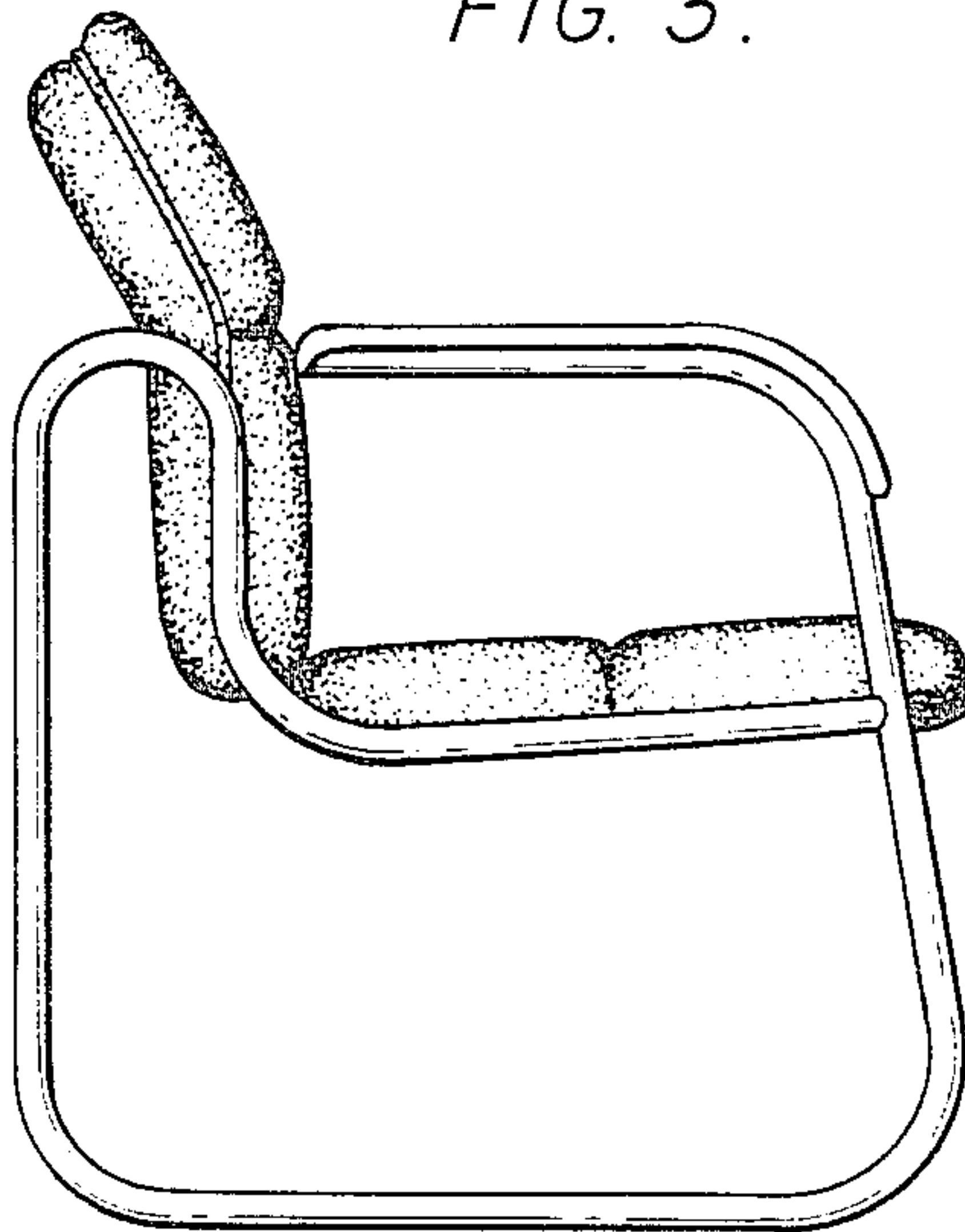

FIG. 4.

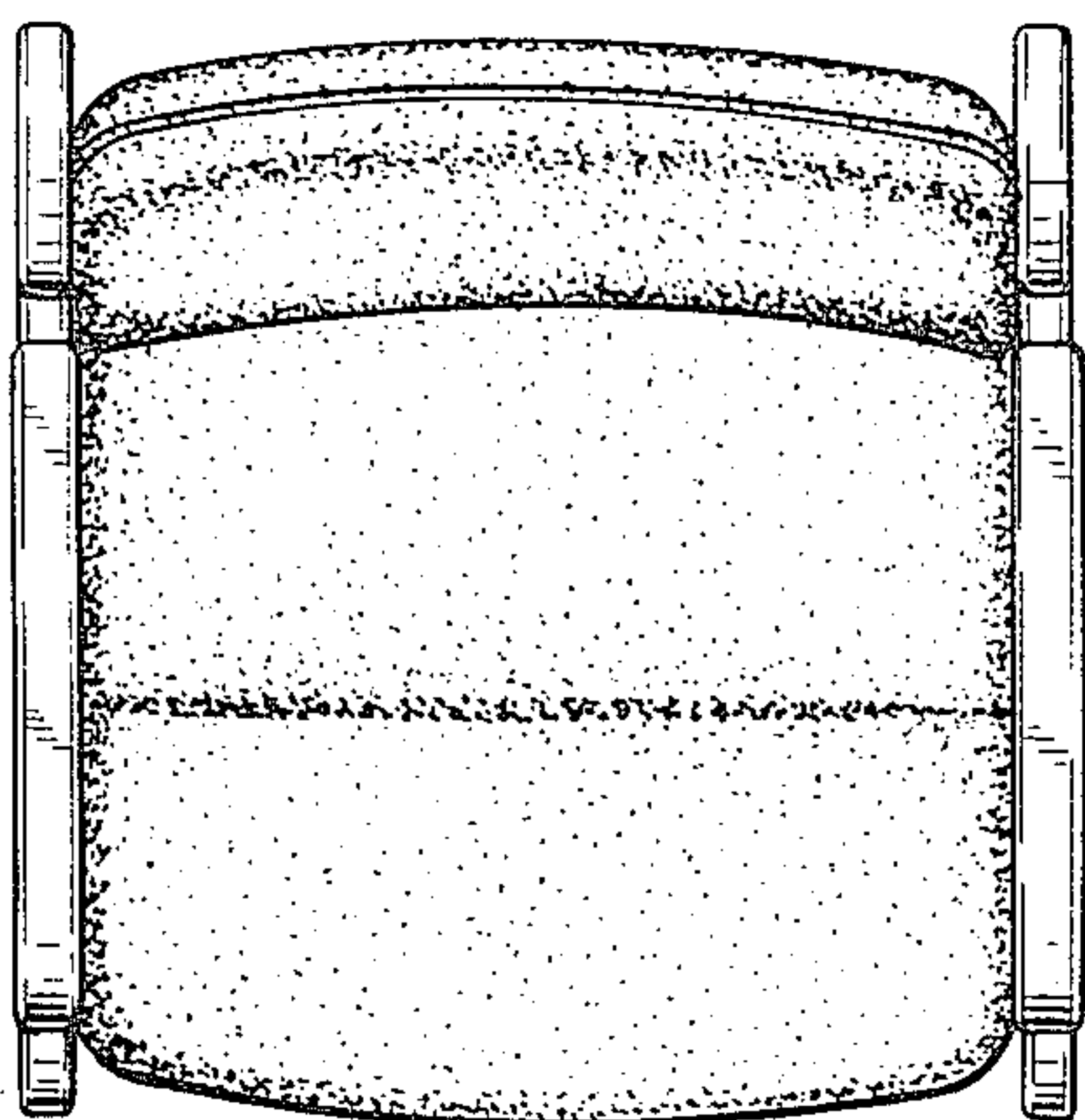

FIG. 5.

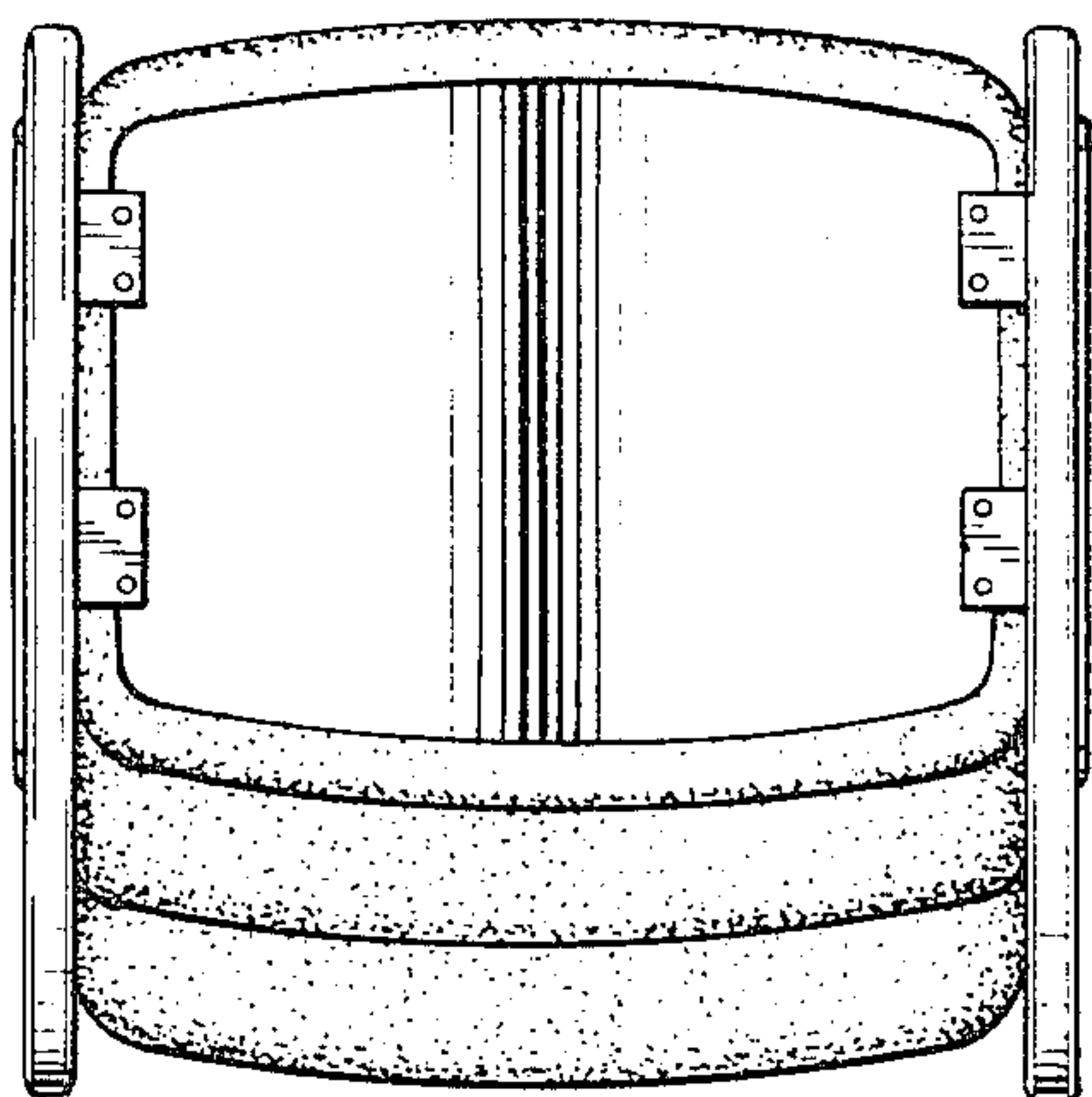

FIG. 6.

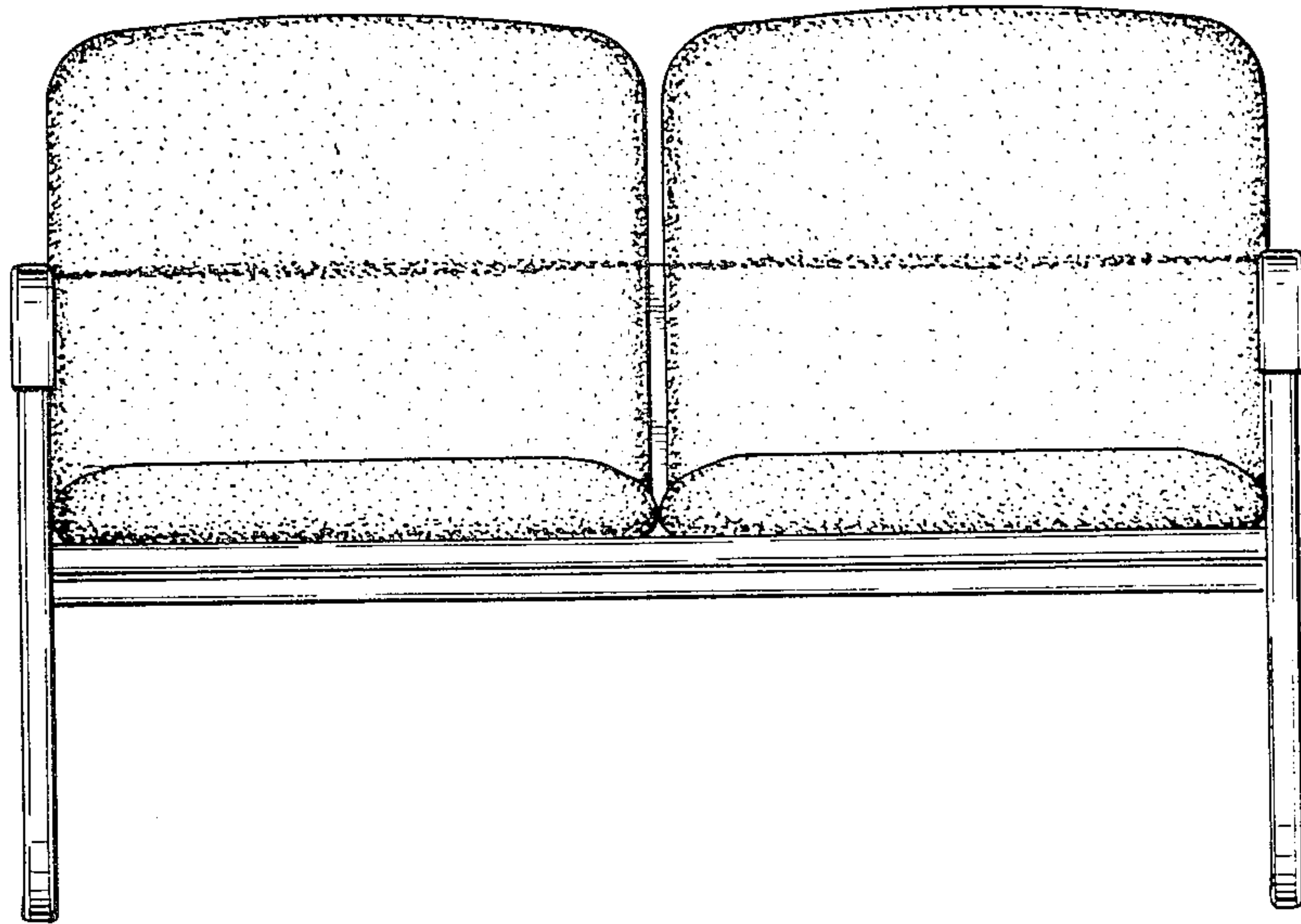

FIG. 7.

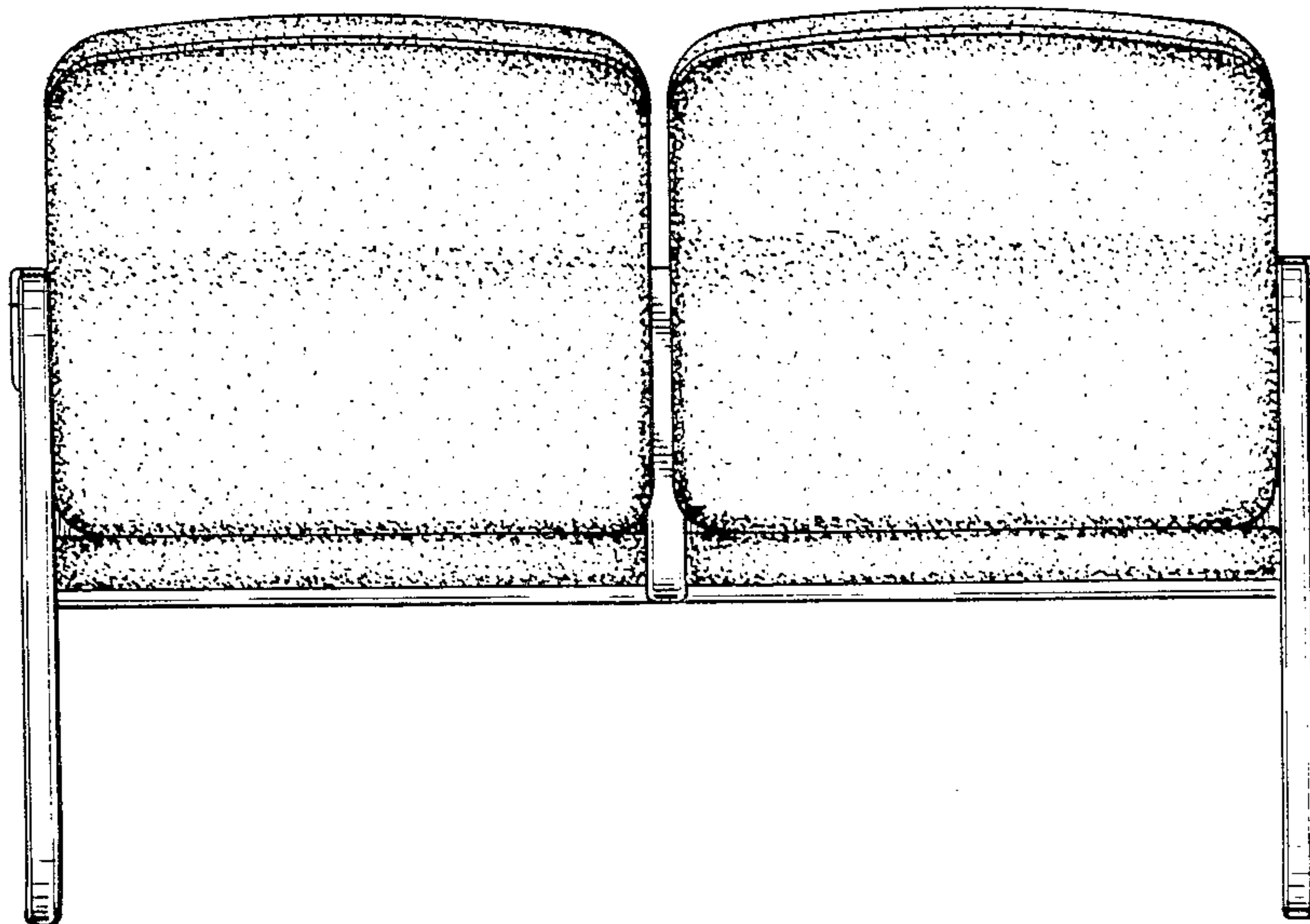

FIG. 8.

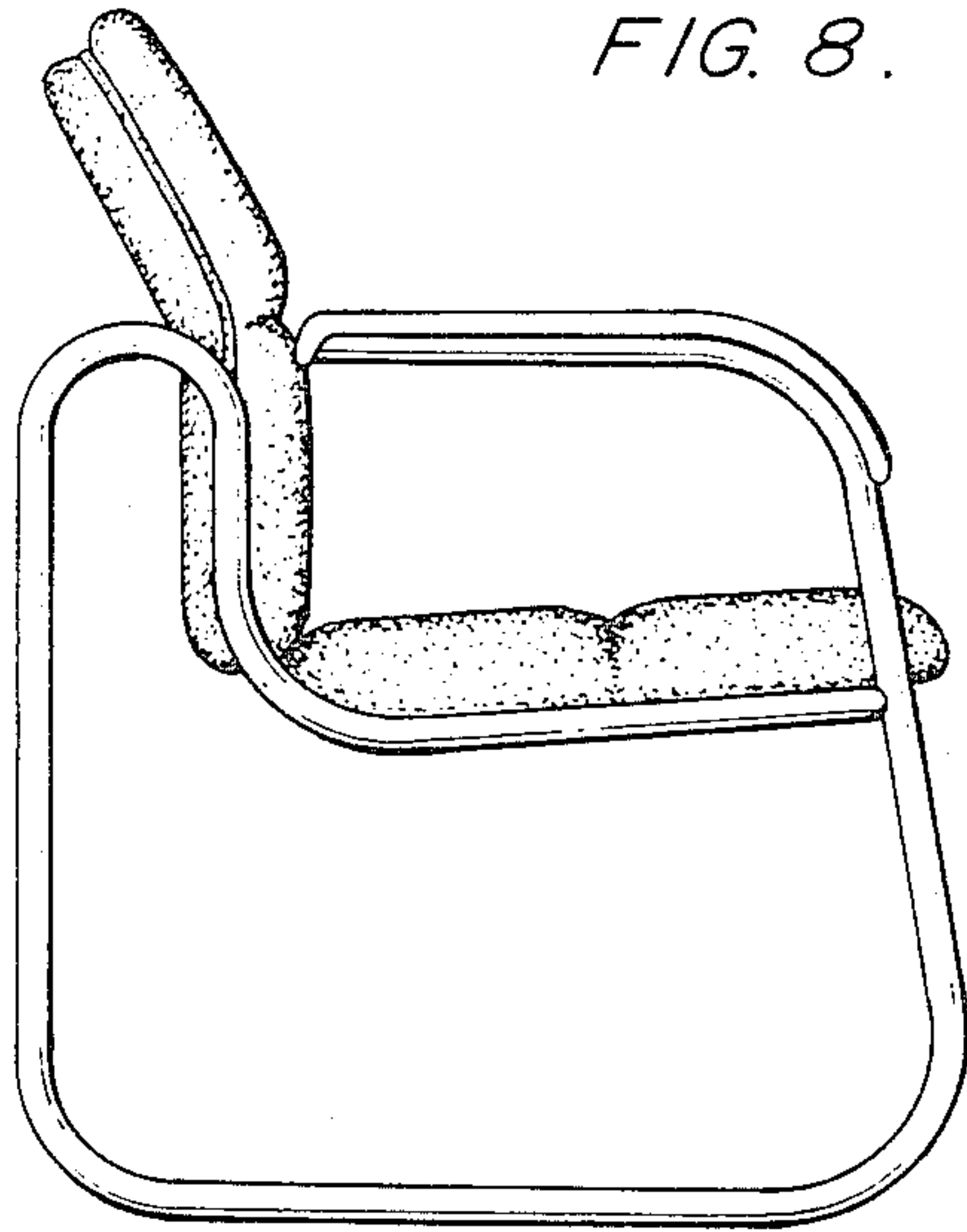

FIG. 9.

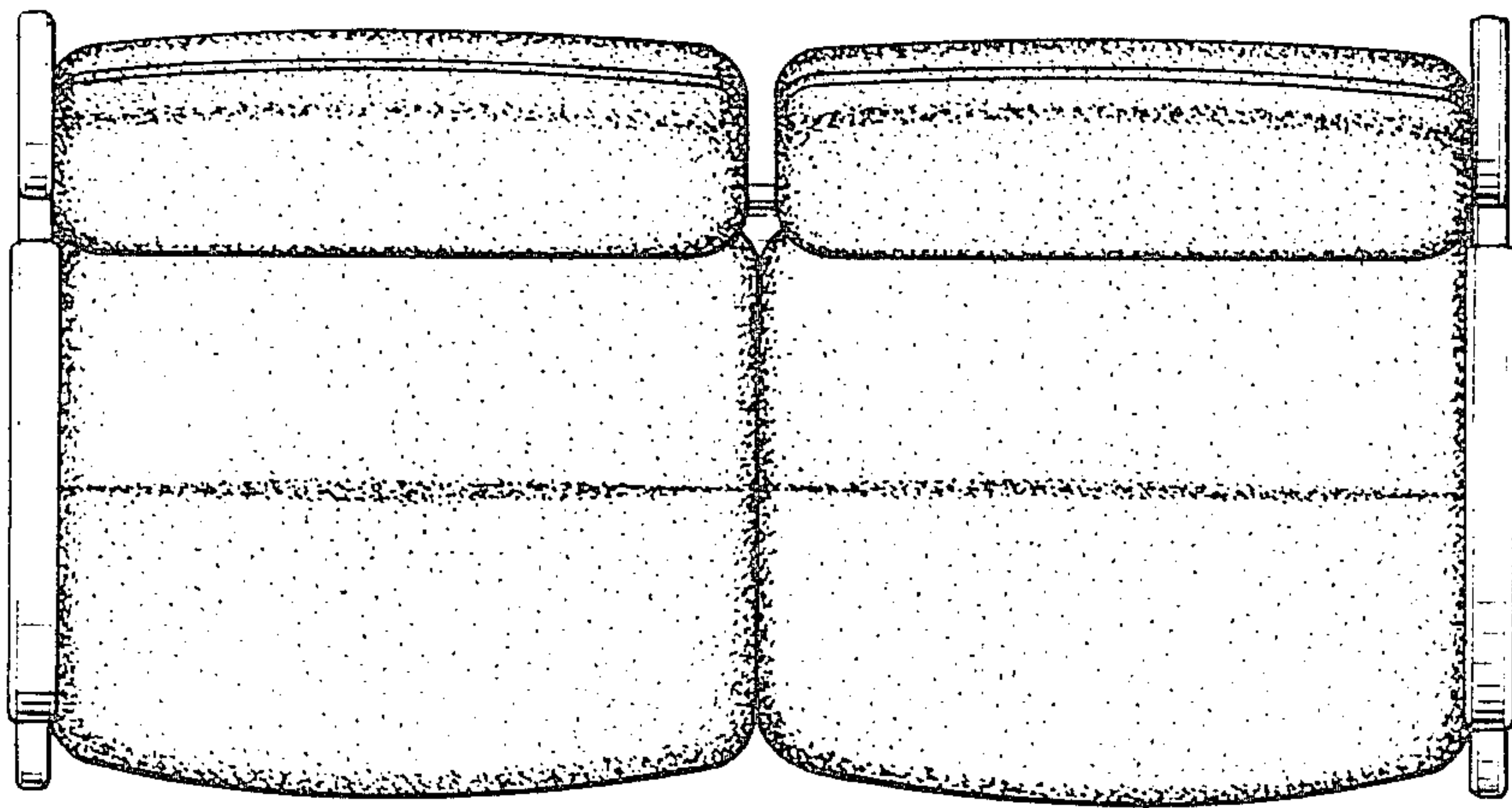

FIG. 10.

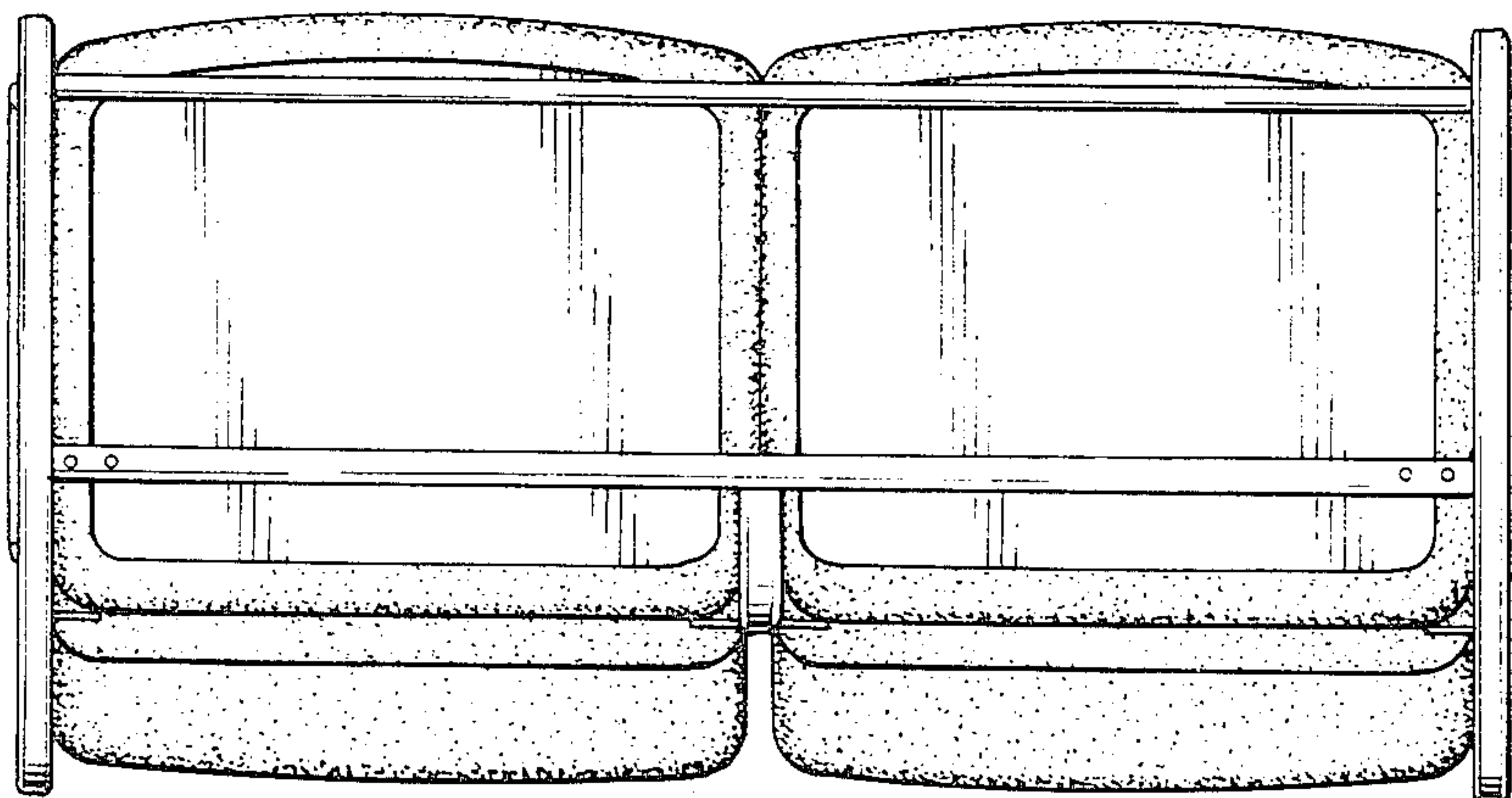

FIG. 11.

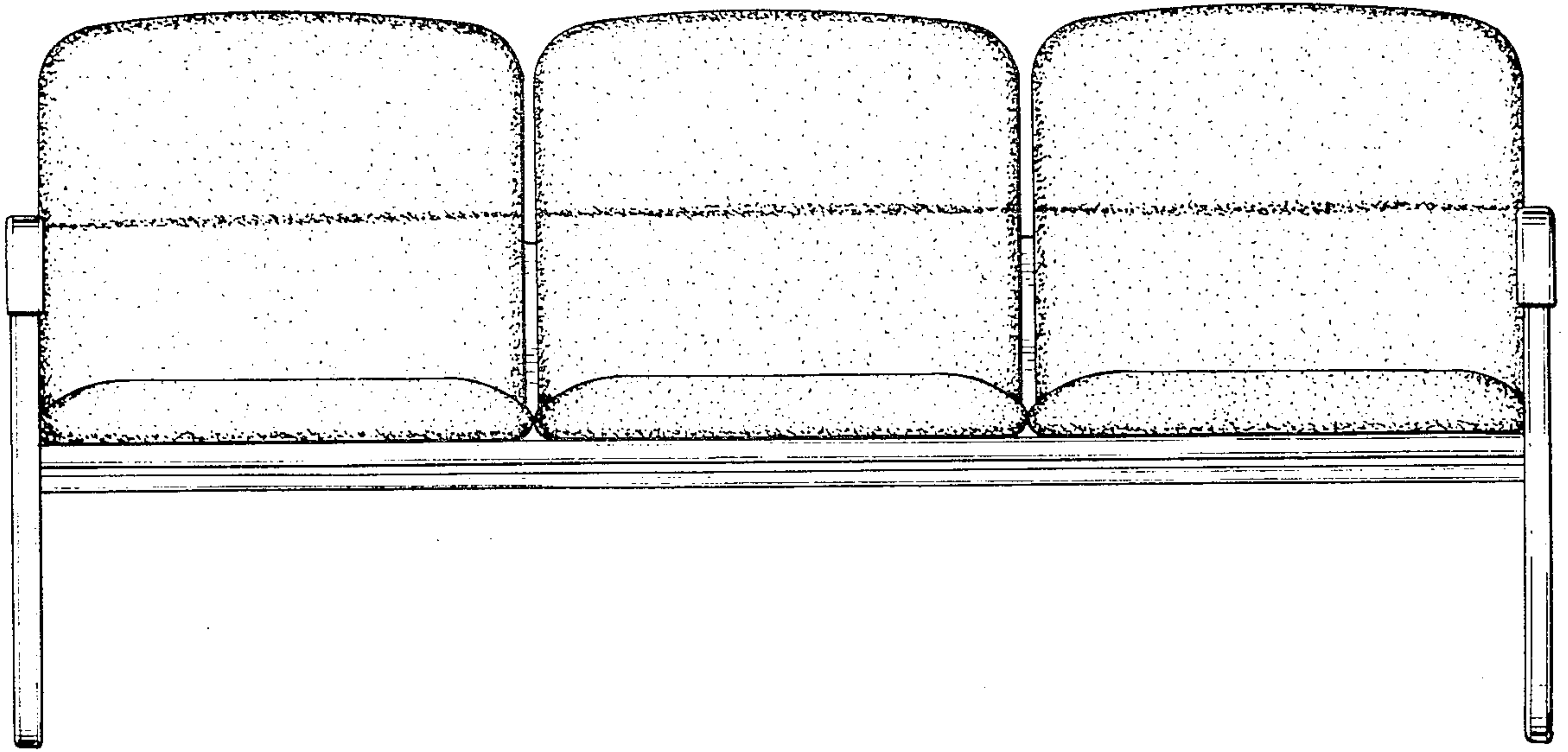

FIG. 12.

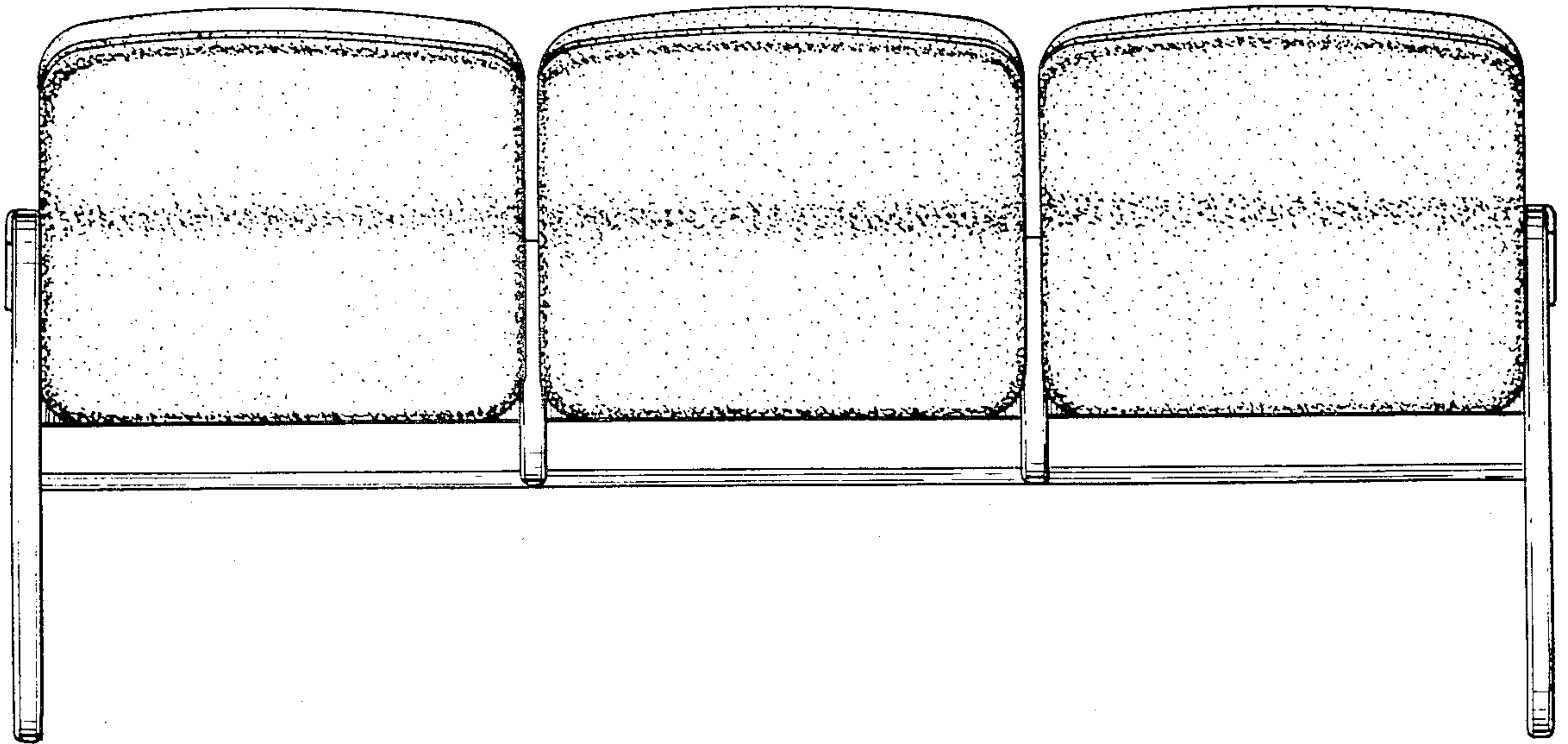

FIG. 13.

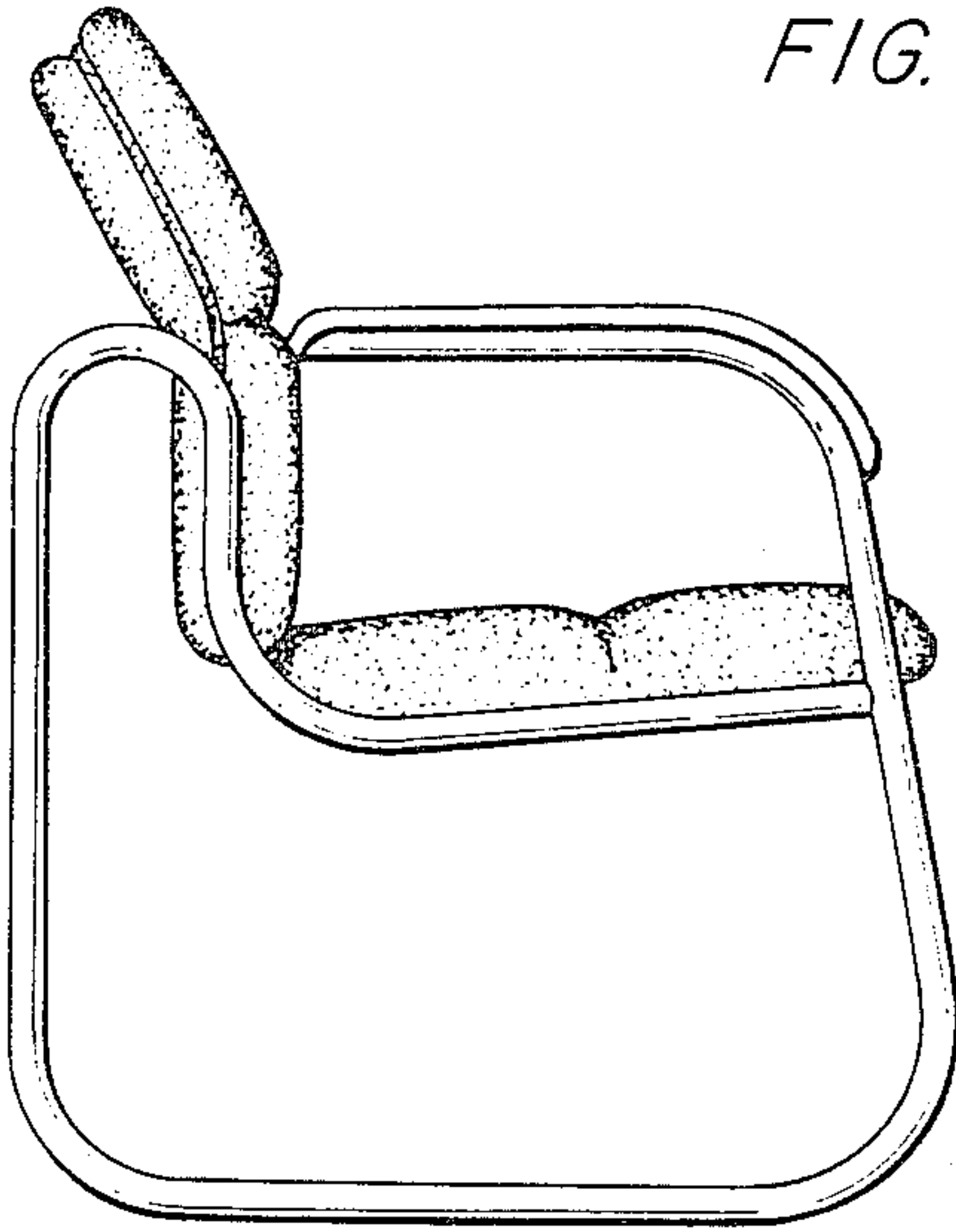

FIG. 14.

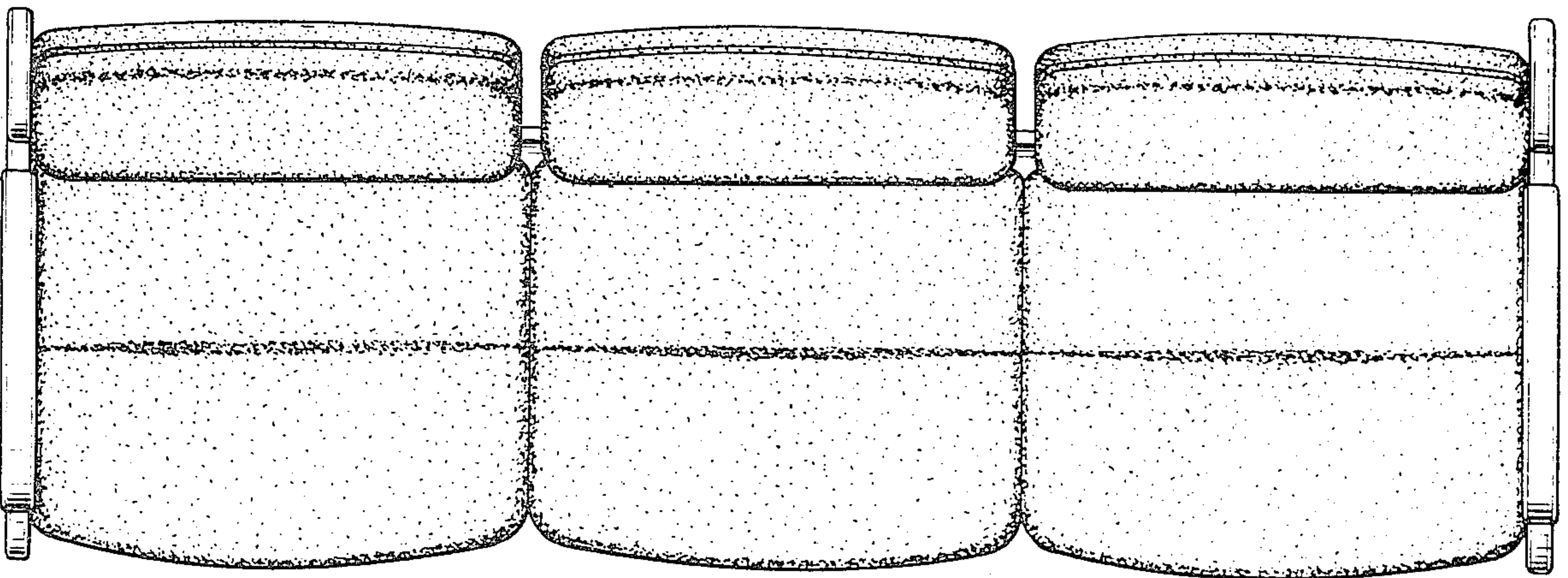

FIG. 15.

