

[54] **ELECTRIC SHAVER**

[75] Inventors: **Kenichi Haruguchi; Yukiko Ito**, both of Osaka, Japan

[73] Assignee: **Sharp Corporation**, Osaka, Japan

[\*\*] Term: **14 Years**

[21] Appl. No.: **452,520**

[22] Filed: **Dec. 23, 1982**

[30] **Foreign Application Priority Data**

Jun. 29, 1982 [JP] Japan ..... 57-29395

[52] U.S. Cl. .... **D28/51**

[58] Field of Search ..... **D28/44-51;**  
30/32, 34 R, 34.1, 41.9, 42-43.92, 44, 45, 85-90

[56] **References Cited**

**U.S. PATENT DOCUMENTS**

- D. 215,994 11/1969 Kubo et al. .... D28/51
- D. 221,504 8/1971 Seiffert ..... D28/51
- D. 231,278 4/1974 Van Lelyveld ..... D28/51

*Primary Examiner*—Louis S. Zarfes  
*Attorney, Agent, or Firm*—Flehr, Hohback, Test, Albritton & Herbert

[57] **CLAIM**

The ornamental design for an electric shaver, as shown and described.

**DESCRIPTION**

FIG. 1 is an exploded perspective view of an electric shaver with the prongs extended showing our new design;

FIG. 2 is a front elevational view thereof without cover and with the prongs retracted;

FIG. 3 is a front elevational view thereof with cover;

FIG. 4 is a right side elevational view thereof without cover;

FIG. 5 is a left side elevational view thereof without cover;

FIG. 6 is a right side elevational view thereof with cover;

FIG. 7 is a top plan view thereof without cover;

FIG. 8 is a top plan view thereof with cover; and

FIG. 9 is a bottom plan view thereof.

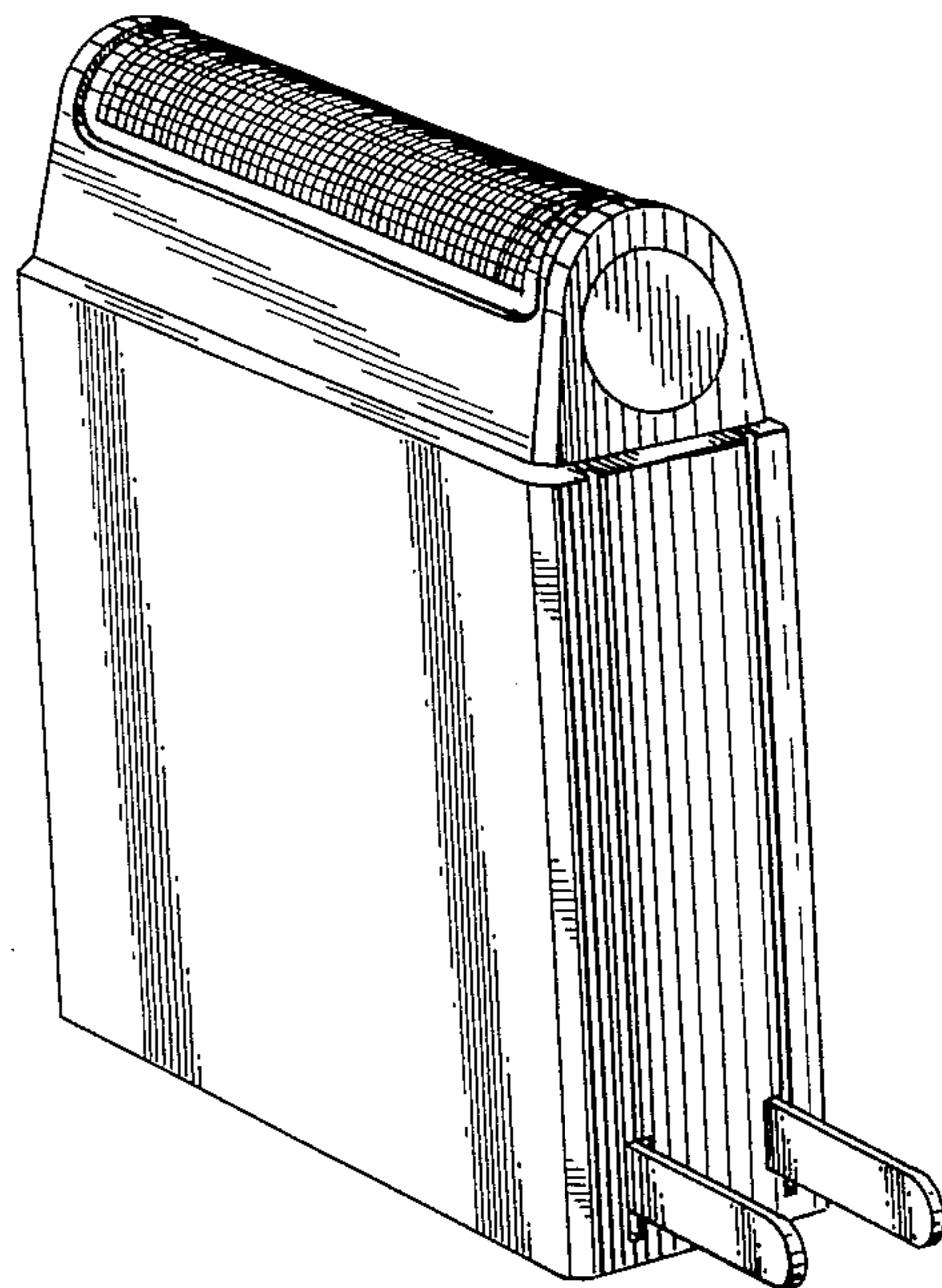
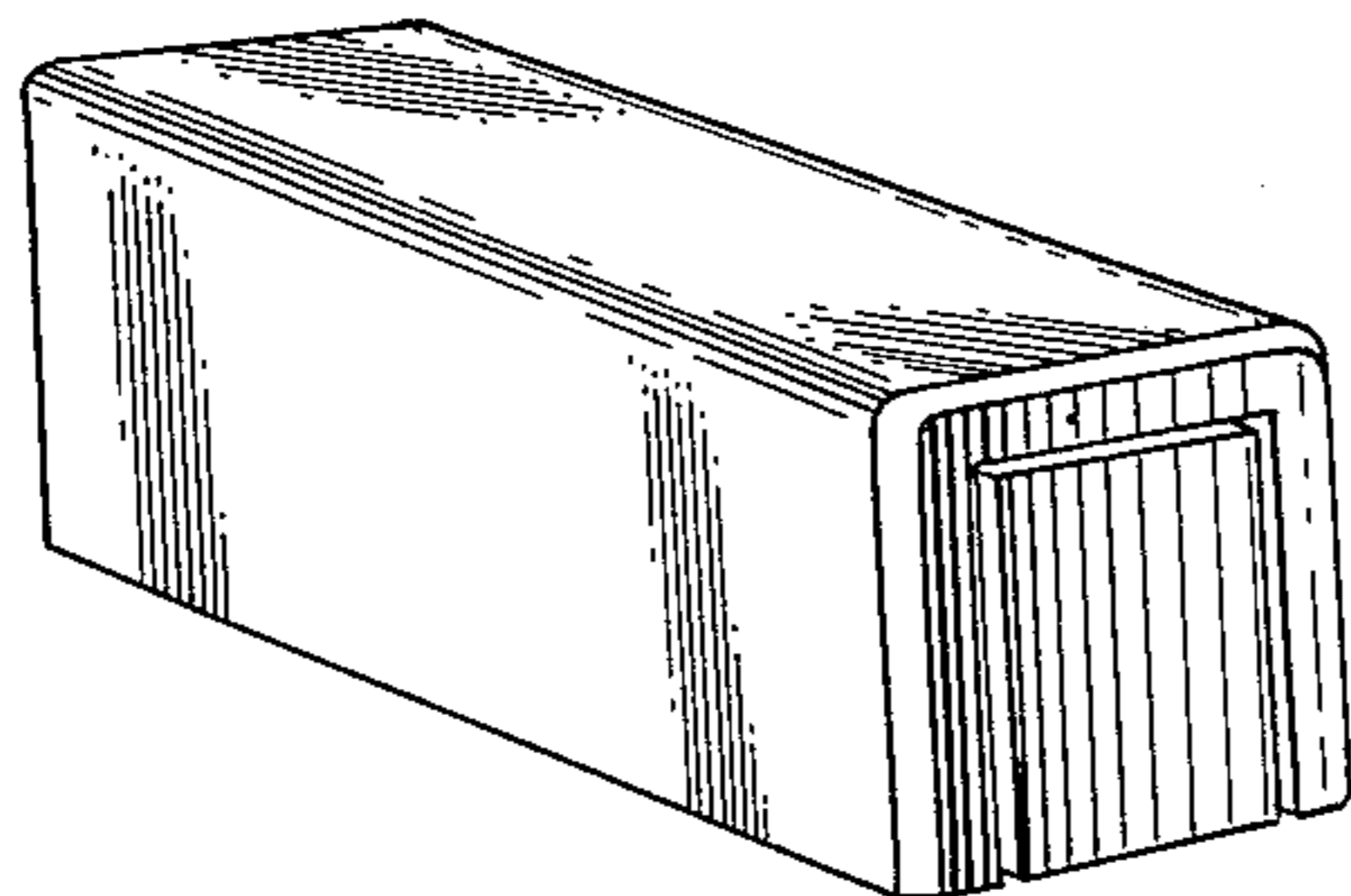

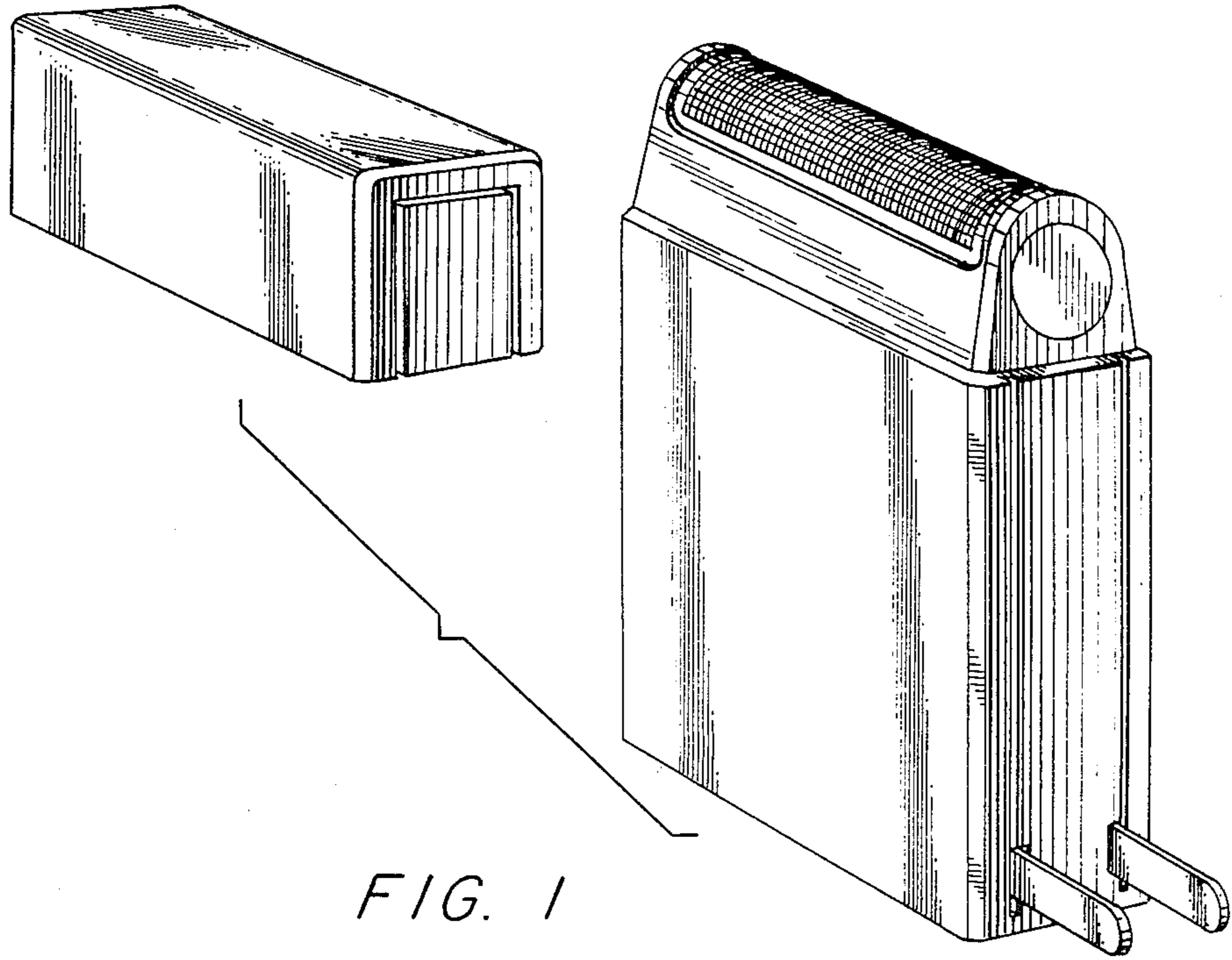

FIG. 1

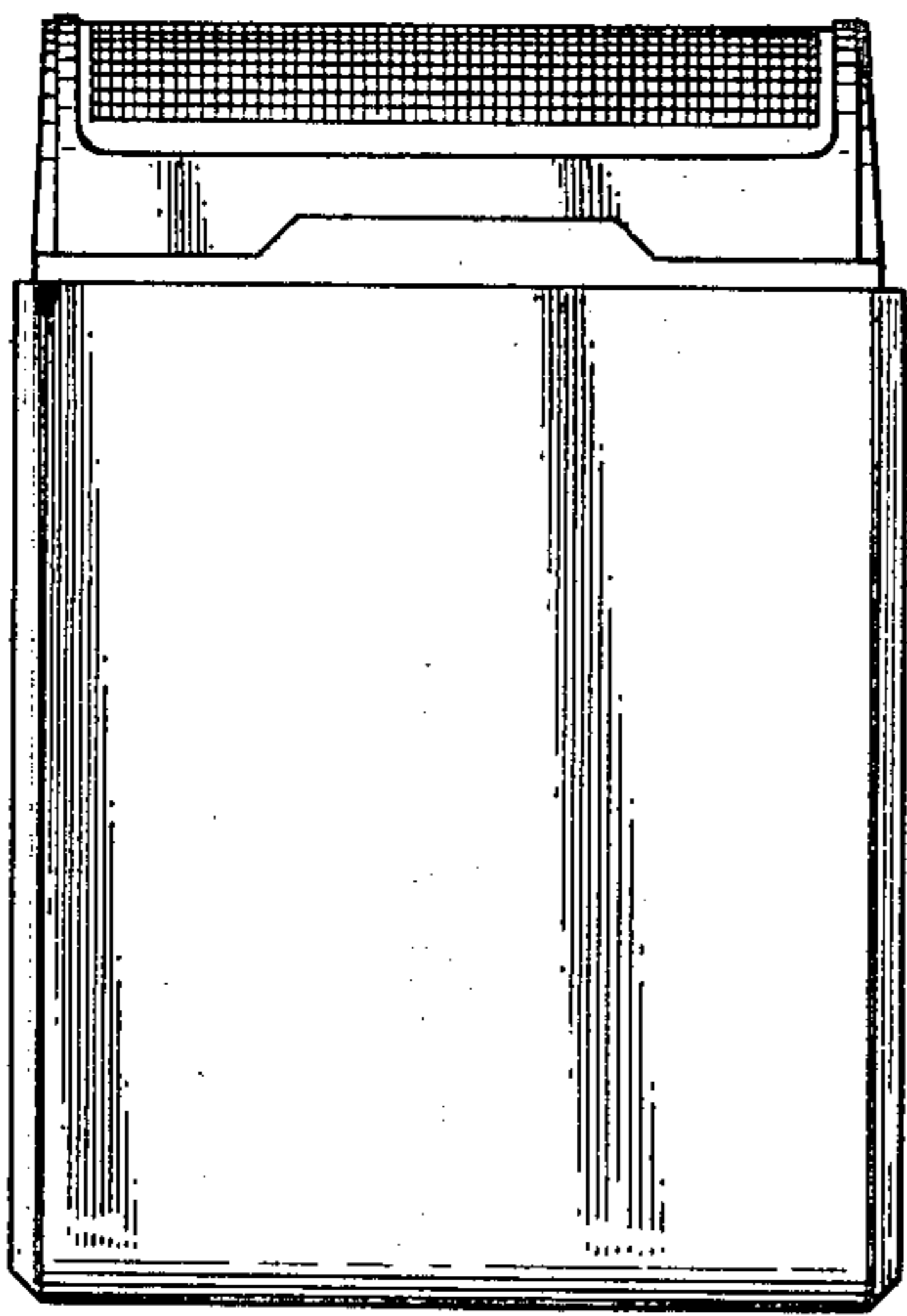

FIG. 2

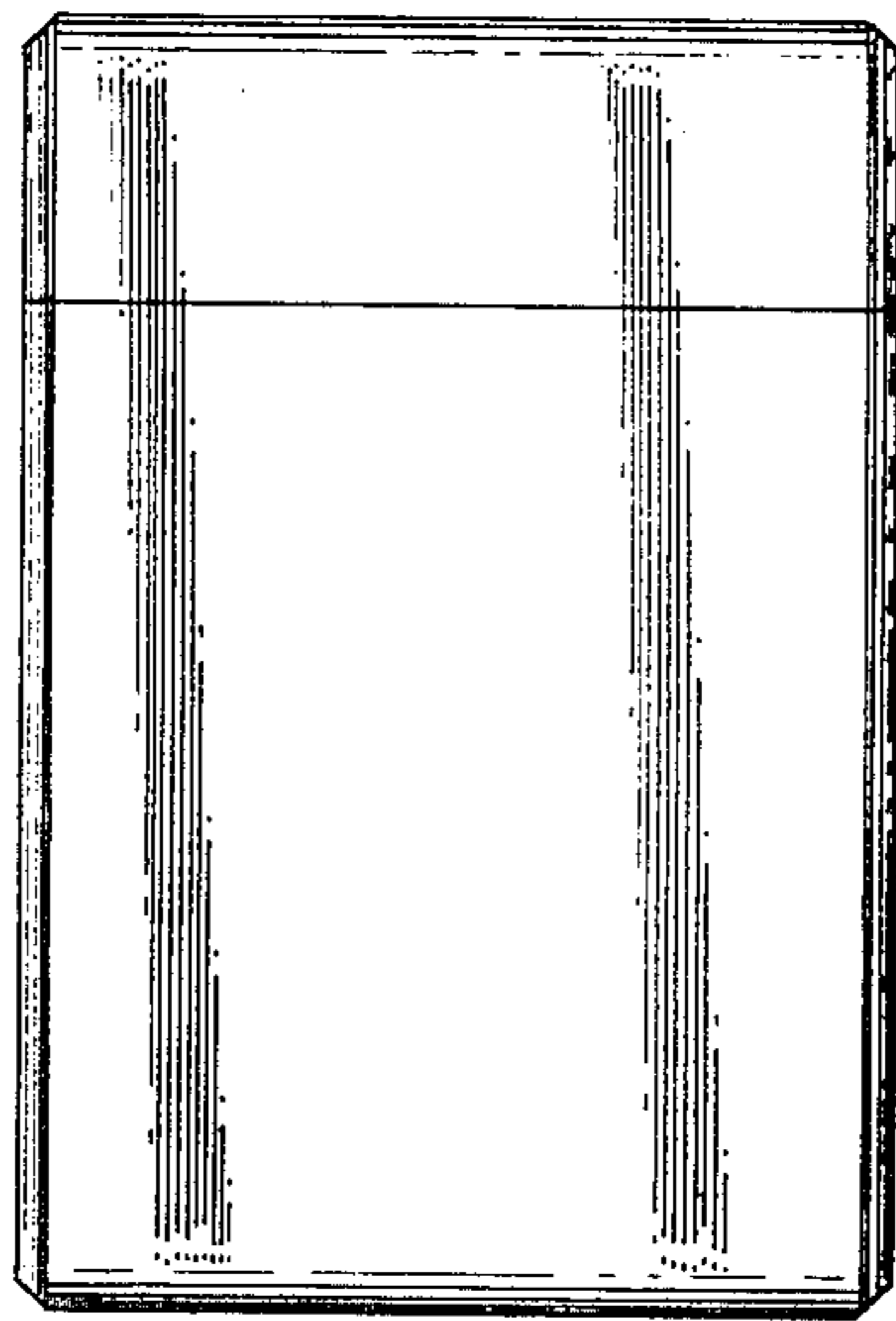

FIG. 3

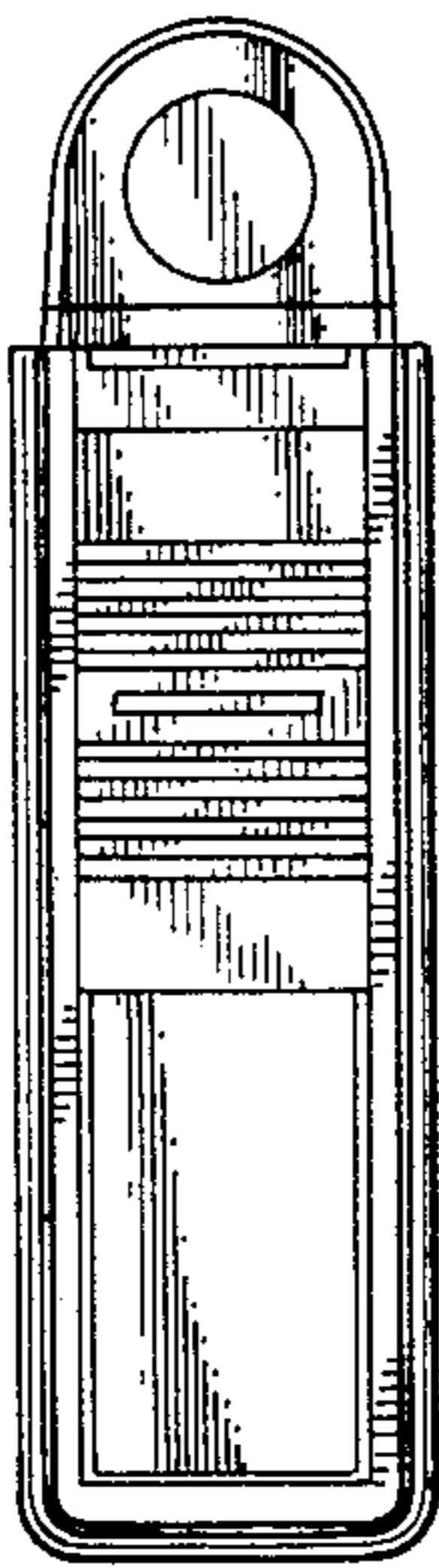

FIG. 4

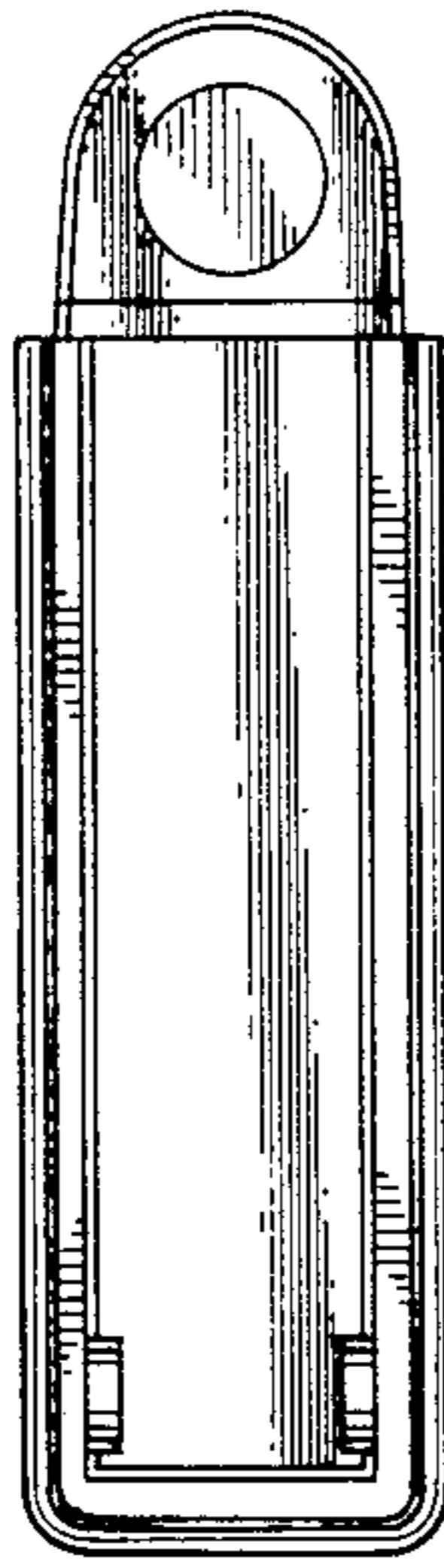

FIG. 5

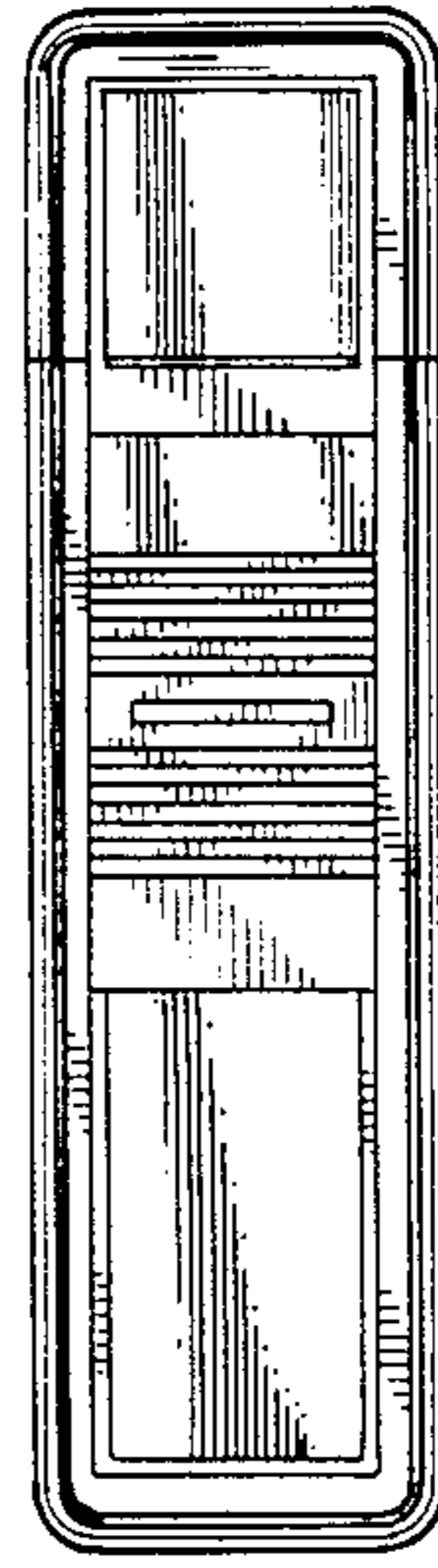

FIG. 6

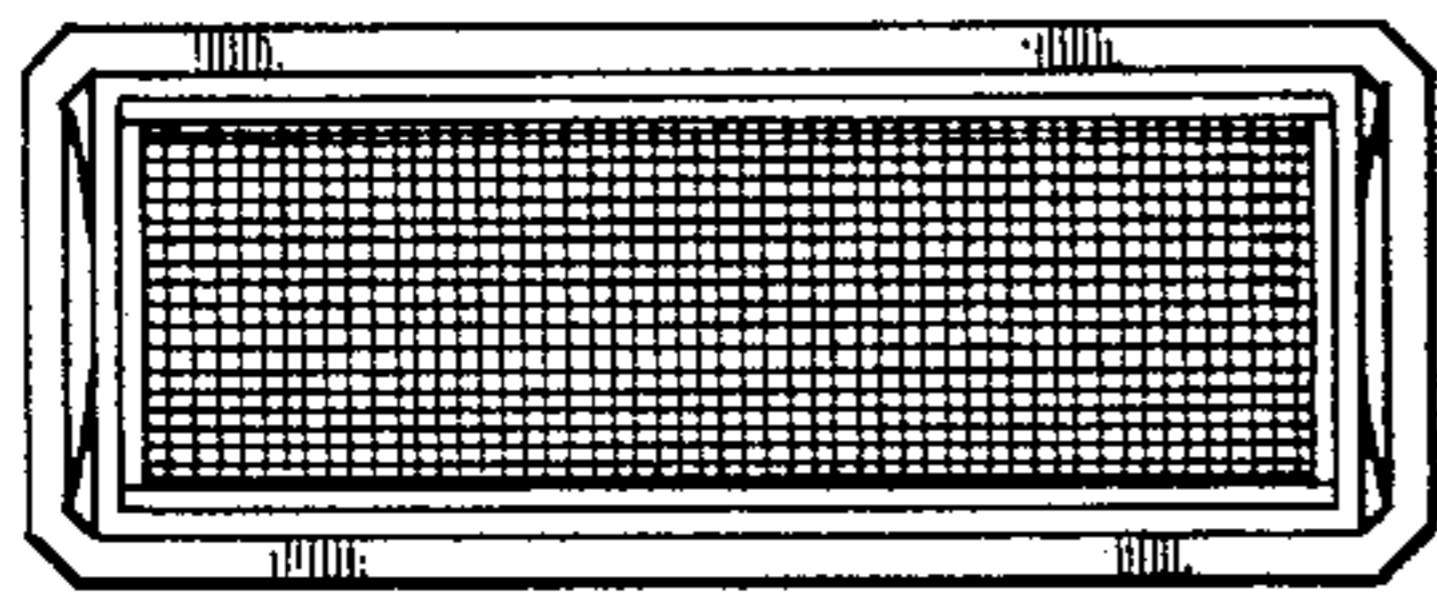

FIG. 7

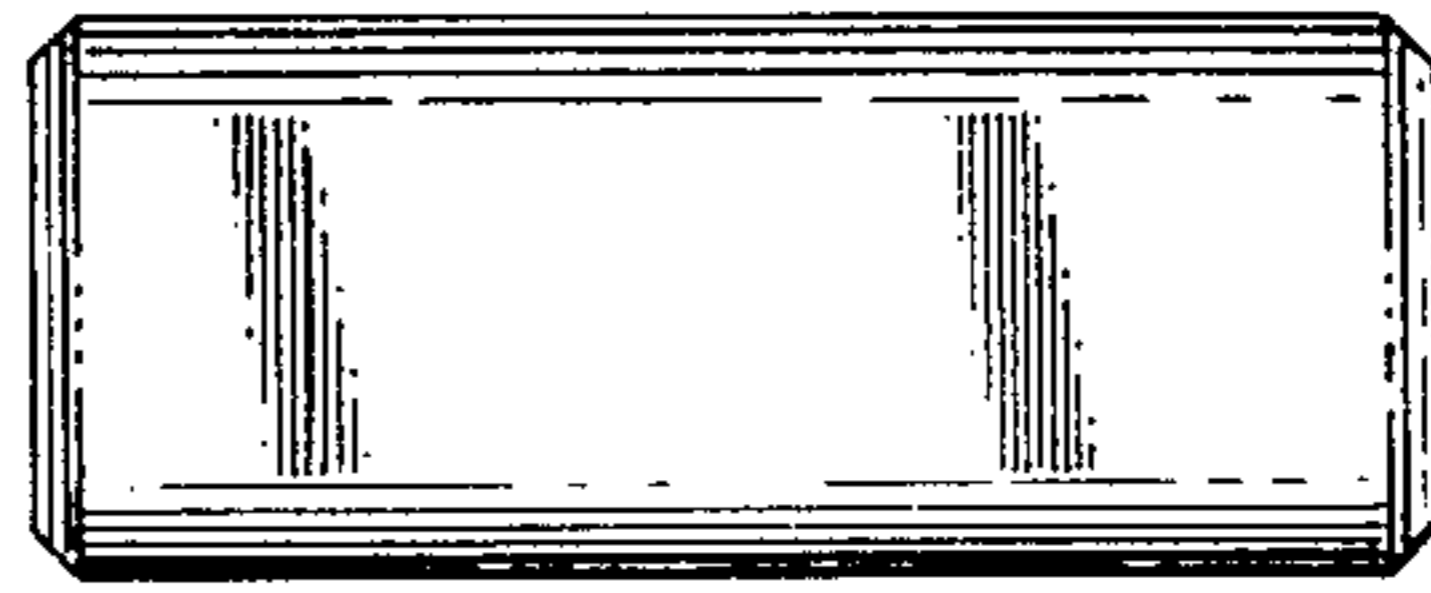

FIG. 8

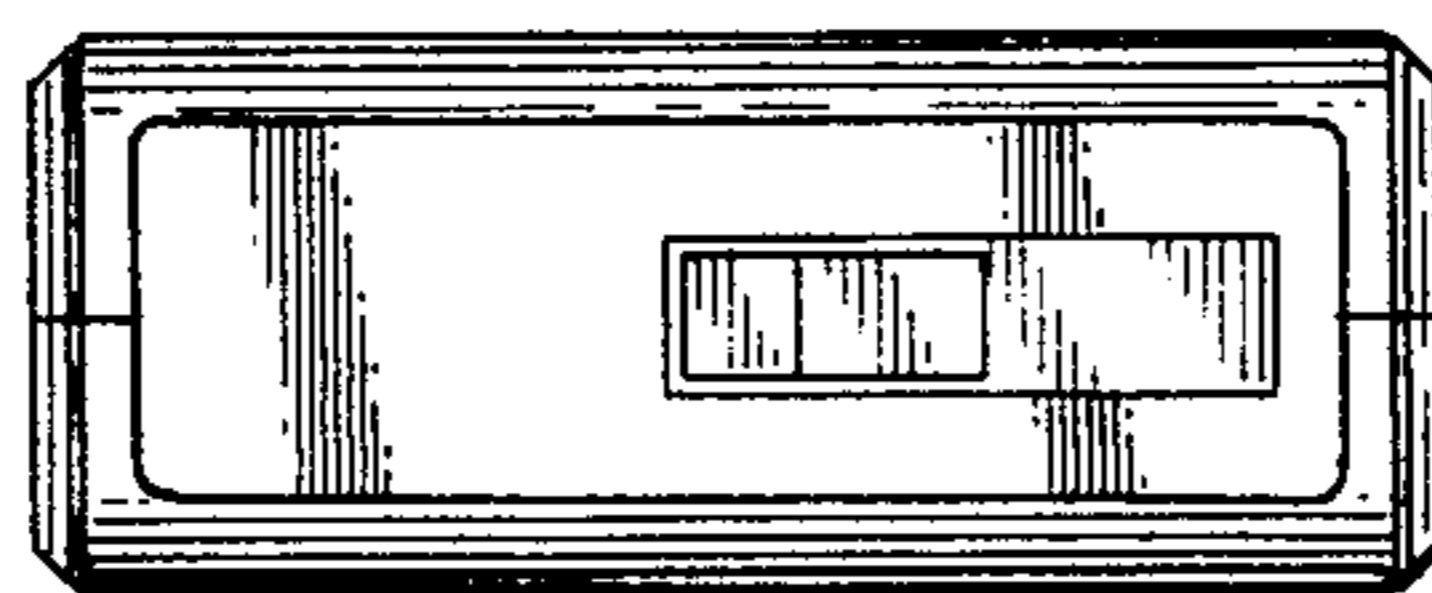

FIG. 9