

[54] SEWING MACHINE

[75] Inventor: Lars G. Rosenblad, Huskvarna, Sweden

[73] Assignee: Husqvarna Aktiebolag, Huskvarna, Sweden

[\*\*] Term: 14 Years

[21] Appl. No.: 324,966

[22] Filed: Nov. 25, 1981

[52] U.S. Cl. .... D15/69

[58] Field of Search ..... D15/66, 67, 68, 69, D15/70, 71, 72, 73, 74, 75, 76, 77, 78; 112/158 R, 258, 259, 261

[56] References Cited

U.S. PATENT DOCUMENTS

- D. 267,321 12/1982 Molineri ..... D15/69
- 1,288,359 12/1918 Wright ..... 112/261

- 2,688,295 9/1954 Neukirgh ..... 112/258
- 3,019,751 2/1962 Fichera ..... 112/261
- 3,204,594 9/1965 Dreyfuss ..... 112/258
- 4,280,420 7/1981 Nishida et al. .... D15/66 X

Primary Examiner—Bernard Ansher  
Assistant Examiner—Carmen H. Vales  
Attorney, Agent, or Firm—Alfred E. Miller

[57] CLAIM

The ornamental design for a sewing machine, as shown and described.

DESCRIPTION

- FIG. 1 is a perspective view of a sewing machine showing my new design.
- FIG. 2 is a top plan view thereof.
- FIG. 3 is a front elevational view thereof.
- FIG. 4 is a bottom plan view thereof.
- FIG. 5 is a left side elevational view thereof.
- FIG. 6 is a right side elevational view thereof.
- FIG. 7 is a rear elevational view thereof.

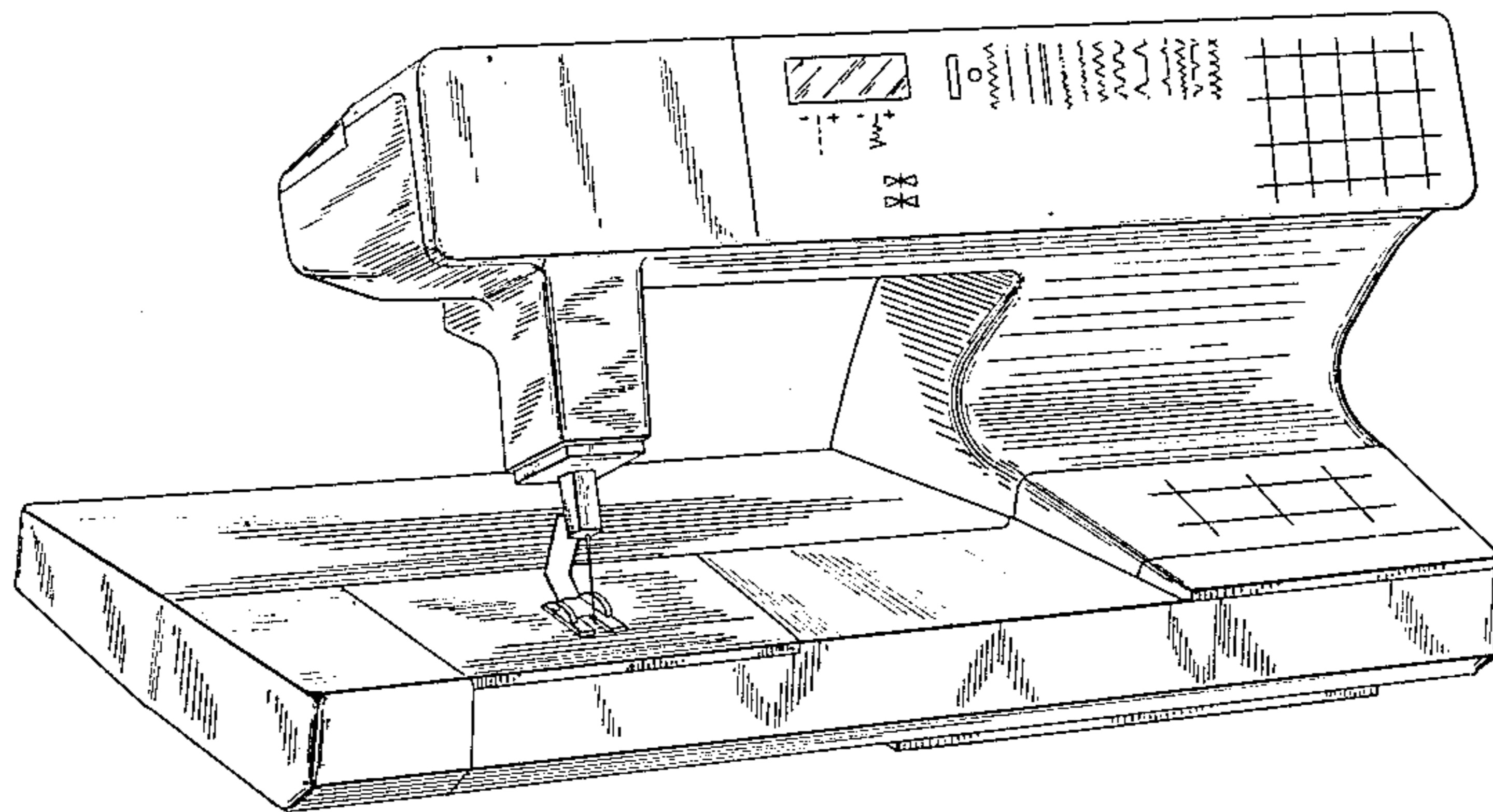

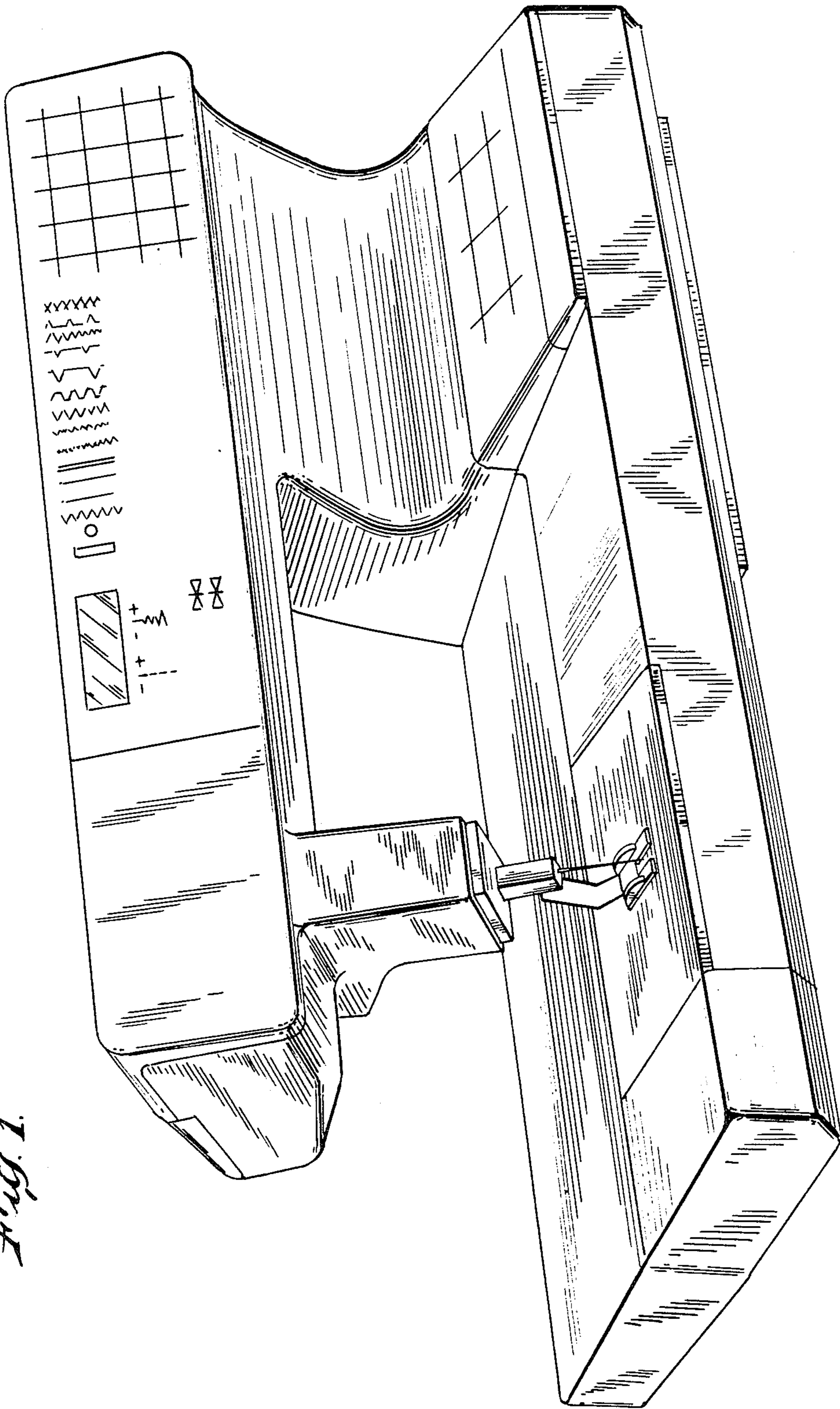
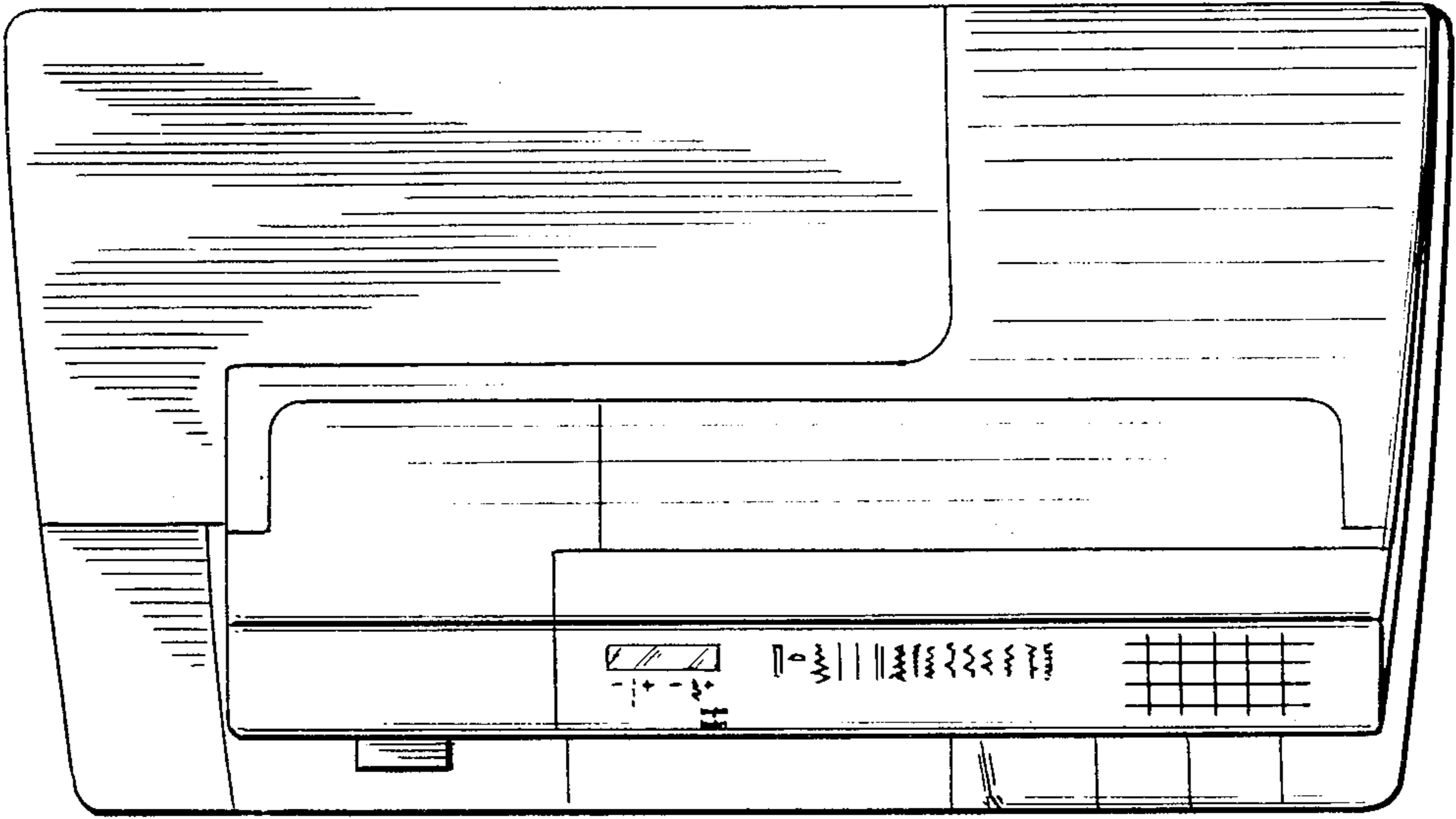
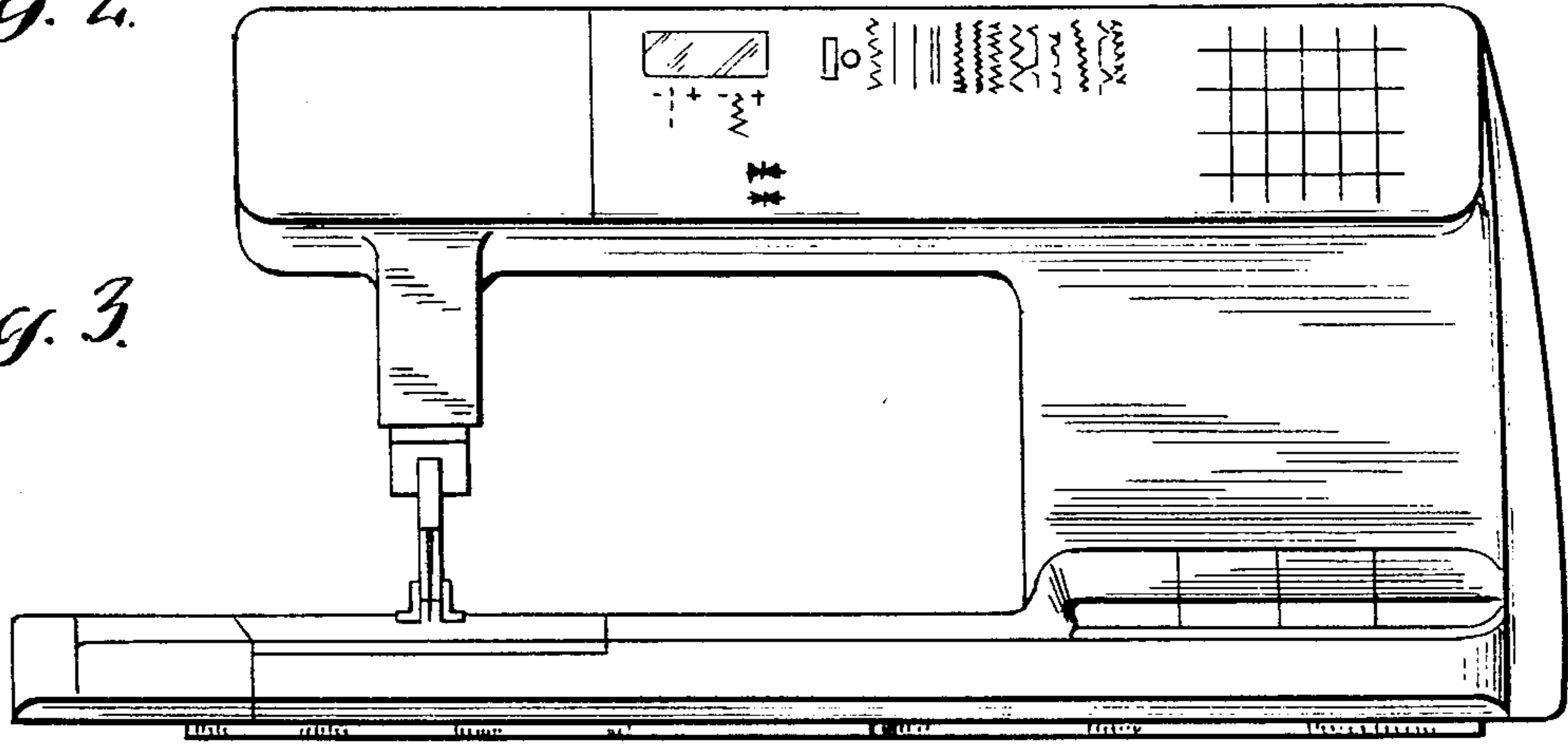

Fig. 1.

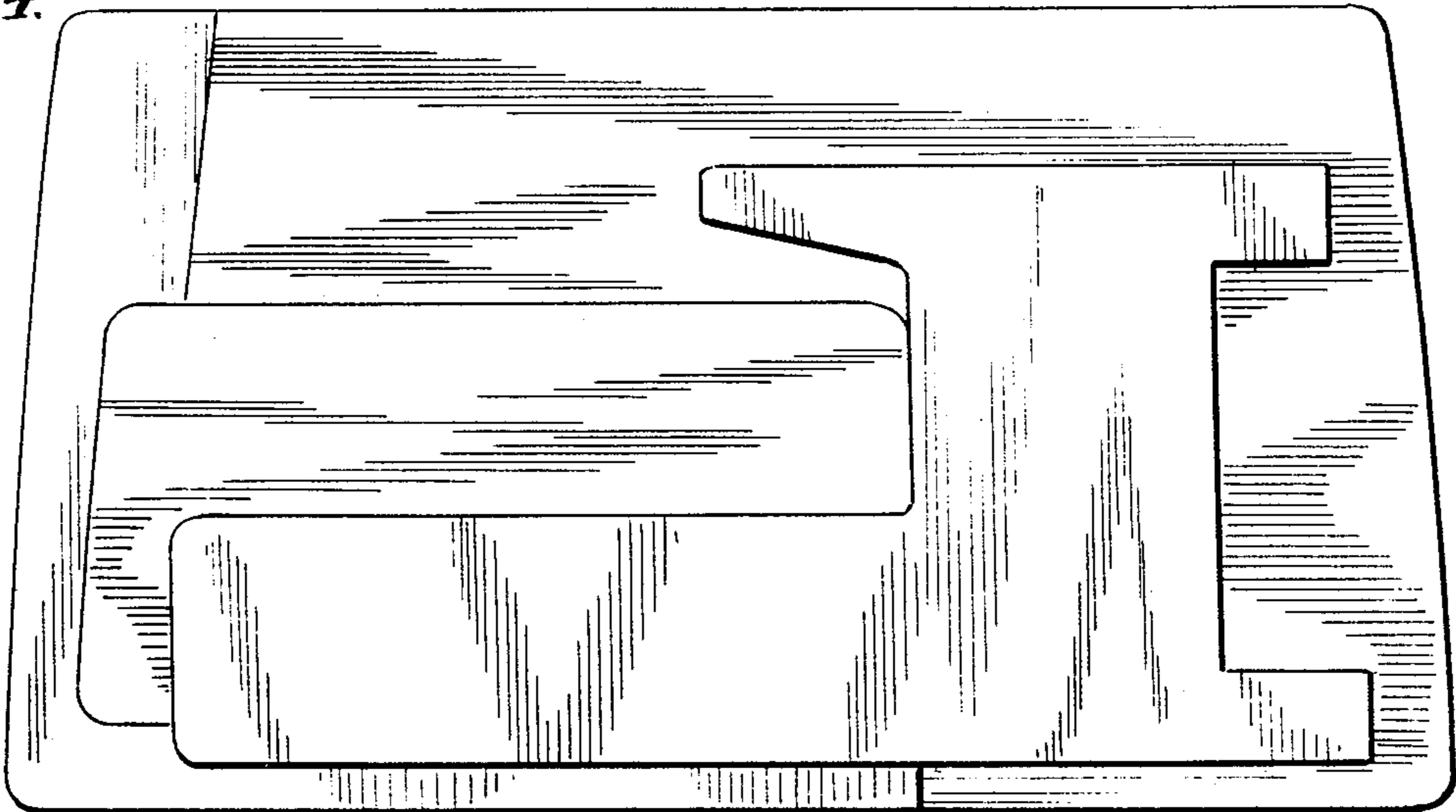

*Fig. 2.*

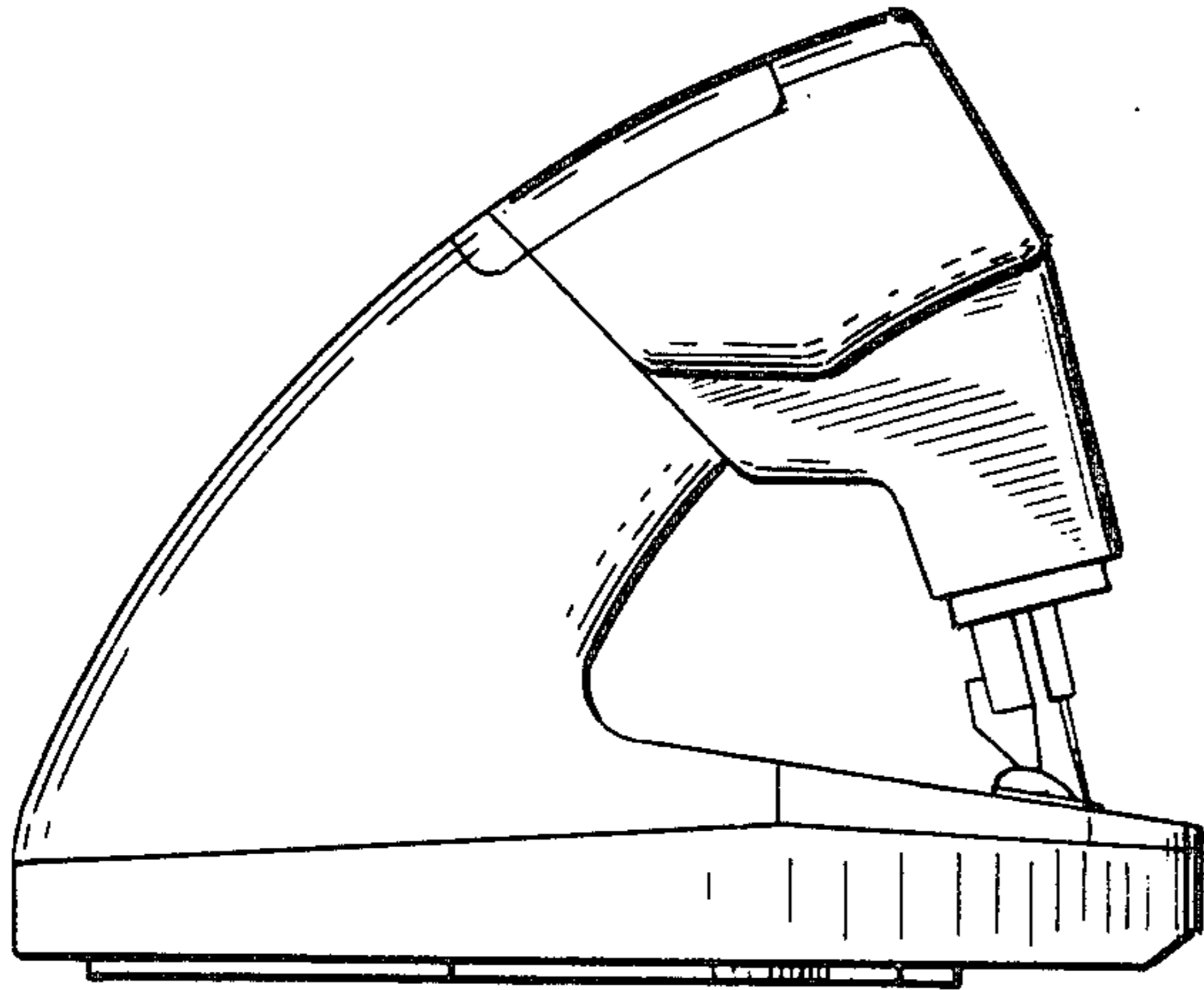

*Fig. 3.*

*Fig. 4.*



*Fig. 5.*



*Fig. 6.*

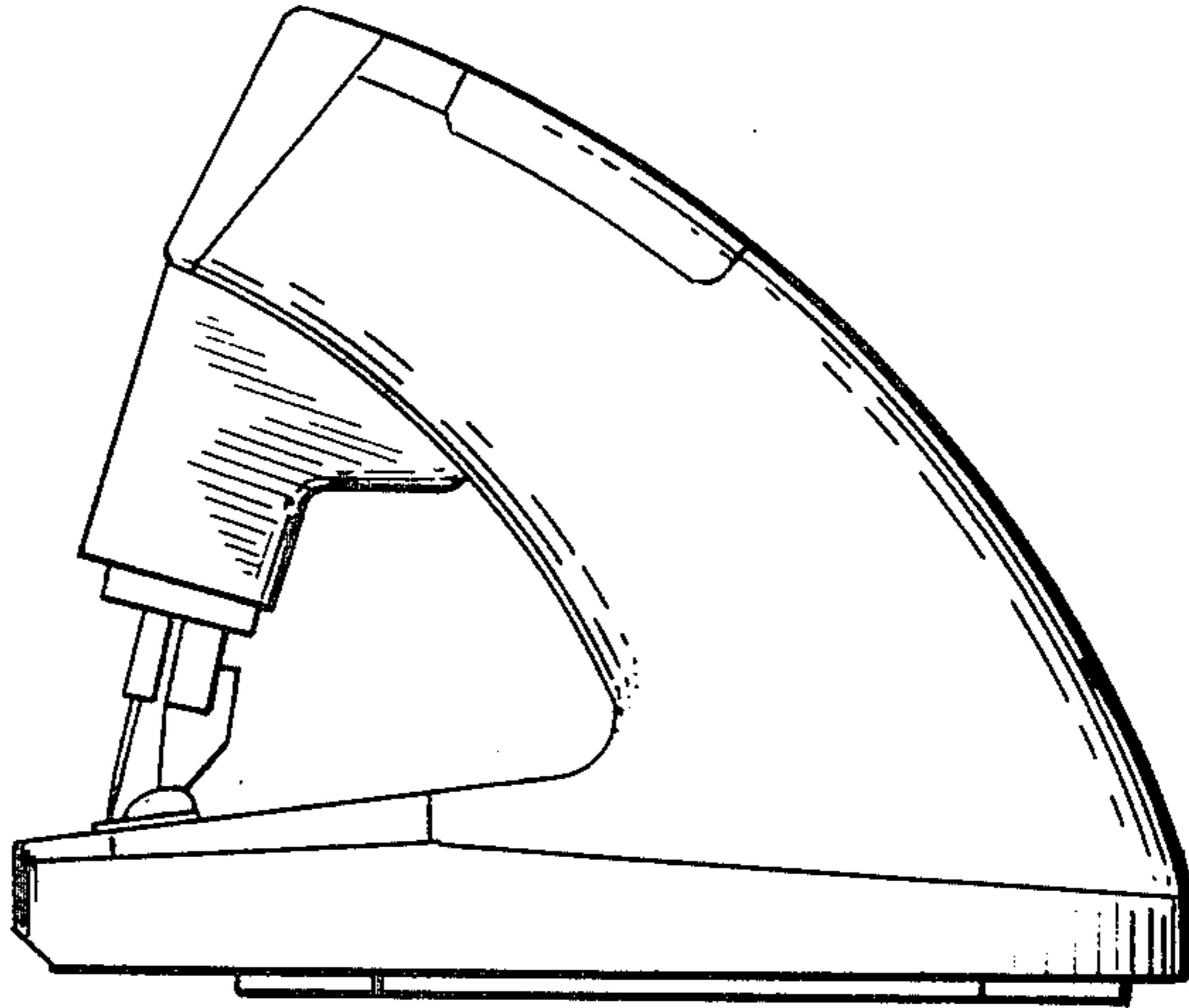

*Fig. 7.*

