

[54] **ELECTRONIC CASH REGISTER**

[75] **Inventors: Junichi Sakamoto; Hiroshi Nishibori,**  
both of Osaka, Japan

[73] **Assignee: Sharp Corporation, Osaka, Japan**

[\*\*] **Term: 14 Years**

[21] **Appl. No.: 410,470**

[22] **Filed: Mar. 15, 1982**

[30] **Foreign Application Priority Data**

Sep. 18, 1981 [JP] Japan ..... 56/41910

[52] **U.S. Cl. .... D18/4**

[58] **Field of Search ..... D18/3, 4; D14/100, 102,**  
D14/105, 106; 235/2, 7 R, 7 A, 145 A, 145 R

[56] **References Cited**

**U.S. PATENT DOCUMENTS**

- D. 220,694 5/1971 Crease et al. .... D18/4
- D. 220,720 5/1971 Kitai ..... D18/4
- D. 233,062 10/1974 Maeda ..... D18/4
- D. 234,266 2/1975 Merino et al. .... D18/4

- D. 235,802 7/1975 Stoltz et al. .... D18/4
- D. 269,623 7/1983 Kato ..... D18/4

**OTHER PUBLICATIONS**

Office Products, Jan. 1979, p. 5.  
Office Products Dealer, Jul. 1981, p. 4.

*Primary Examiner*—Bernard Ansher  
*Assistant Examiner*—Theodore M. Shooman  
*Attorney, Agent, or Firm*—Flehr, Hohbach, Test,  
Albritton & Herbert

[57] **CLAIM**

The ornamental design for an electronic cash register,  
as shown and described.

**DESCRIPTION**

FIG. 1 is a perspective view of the electronic cash register showing our new design;  
FIG. 2 is a front elevational view thereof;  
FIG. 3 is a rear elevational view thereof;  
FIG. 4 is a top plan view thereof;  
FIG. 5 is a right side elevational view thereof; and  
FIG. 6 is a left side elevational view thereof.

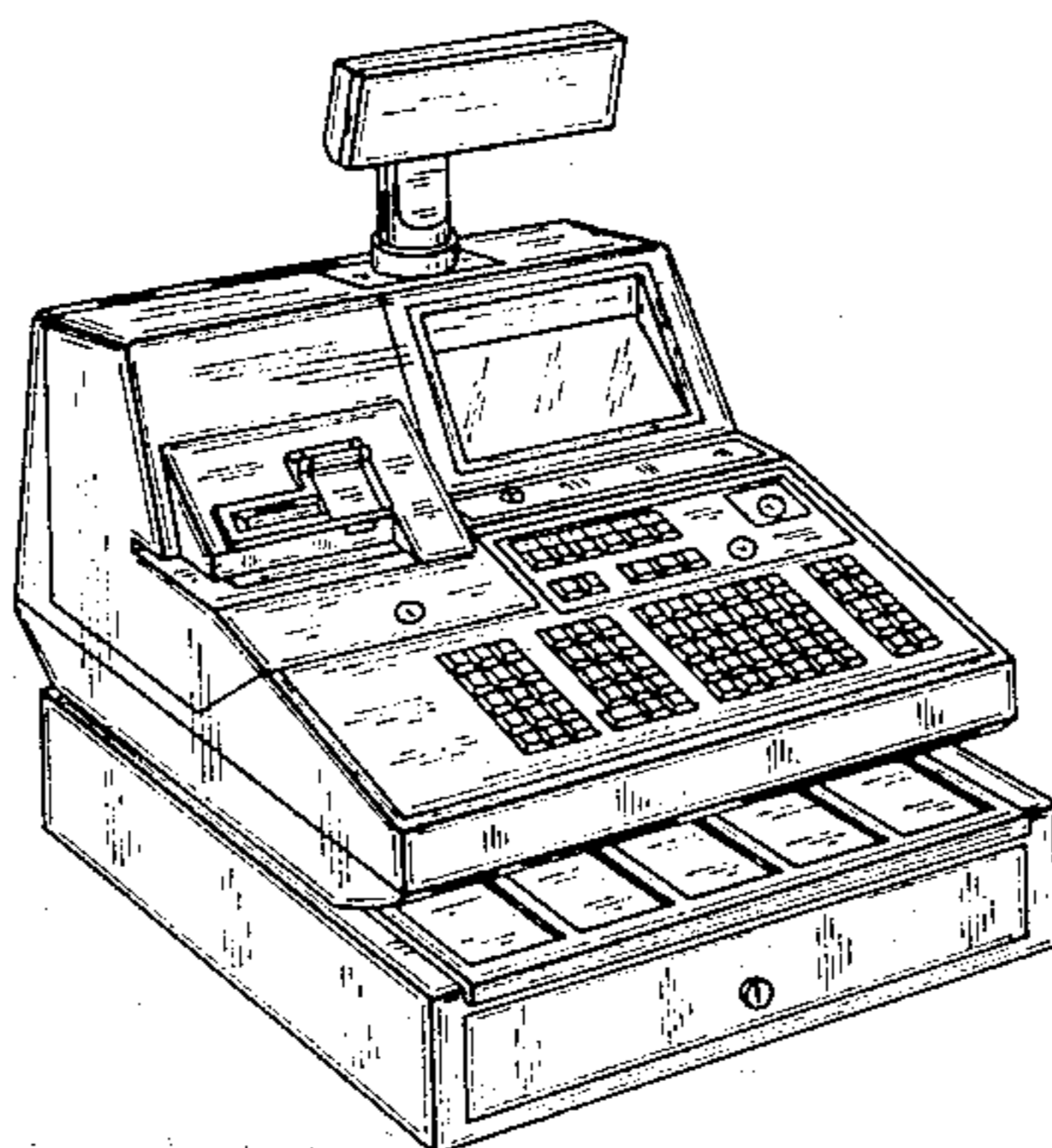

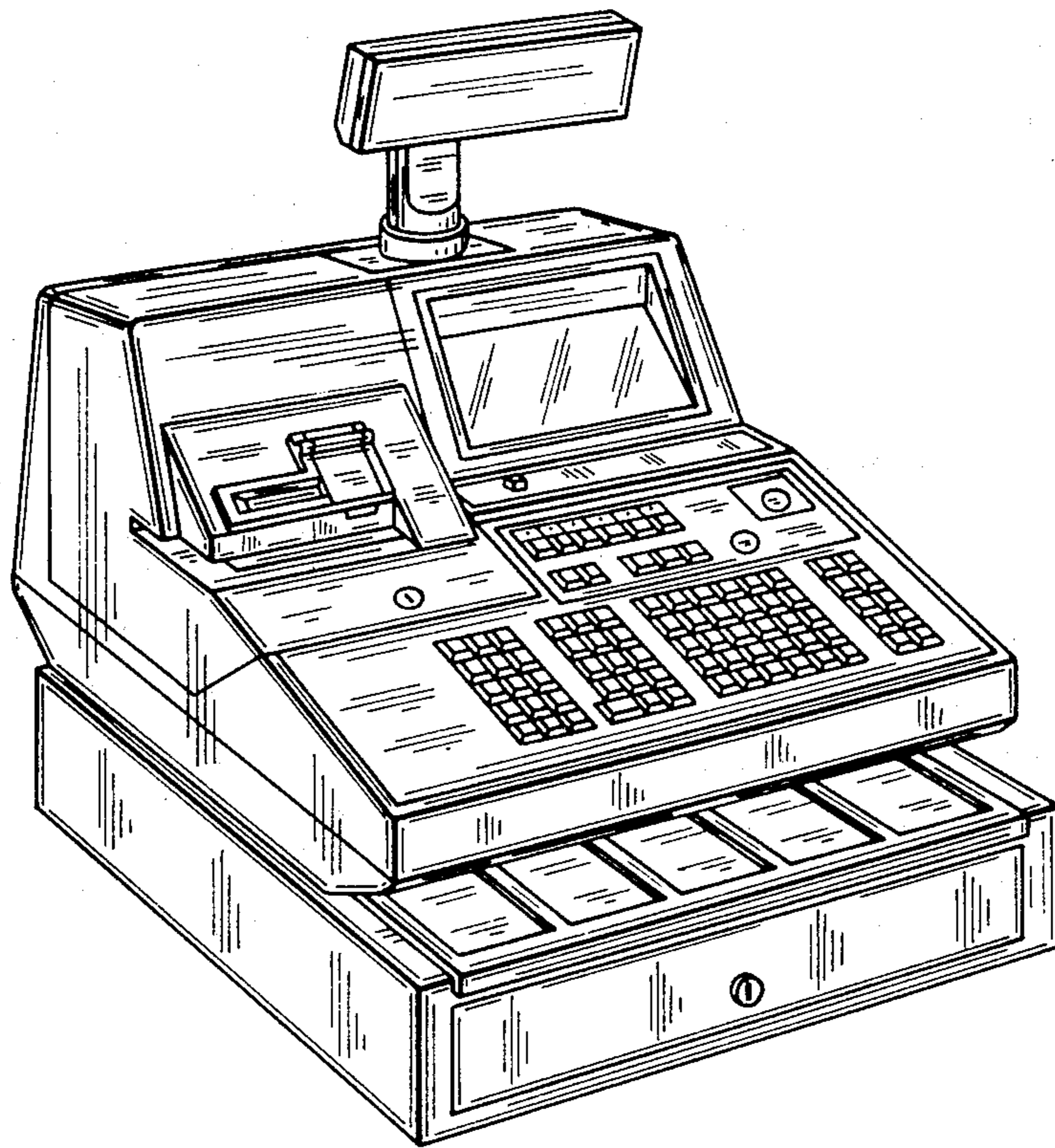

*FIG\_1*

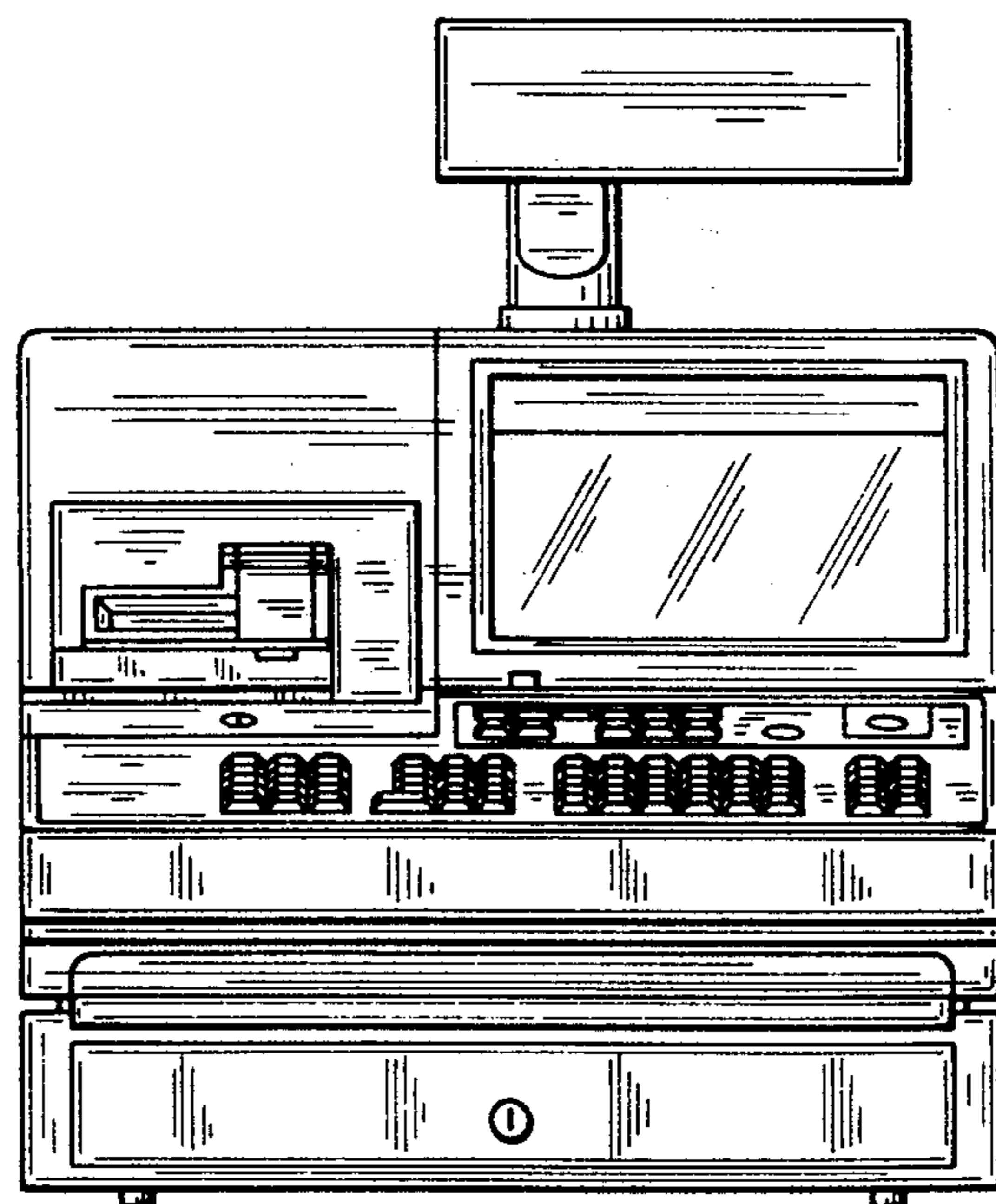

*FIG\_2*

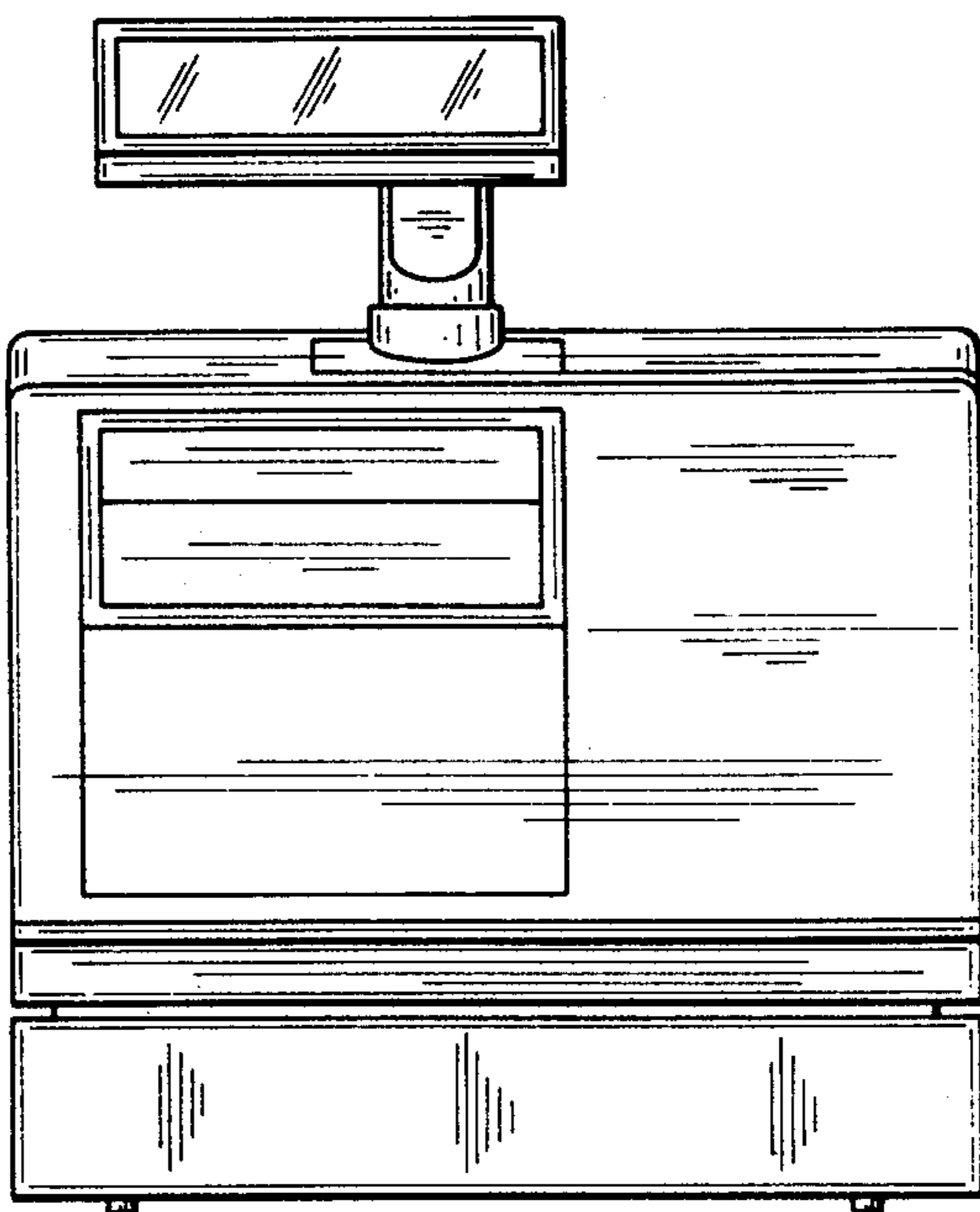

**FIG\_3**

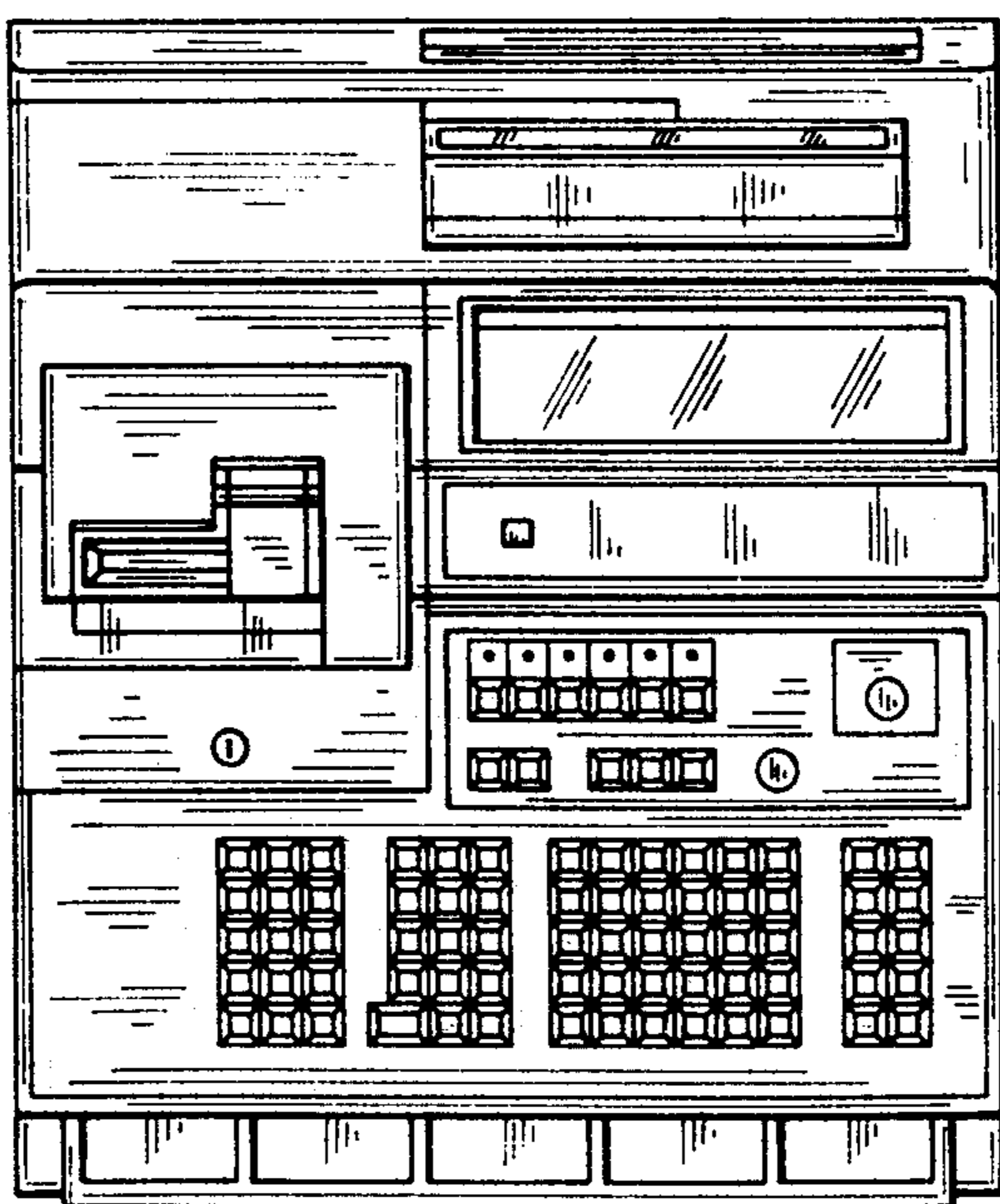

**FIG\_4**

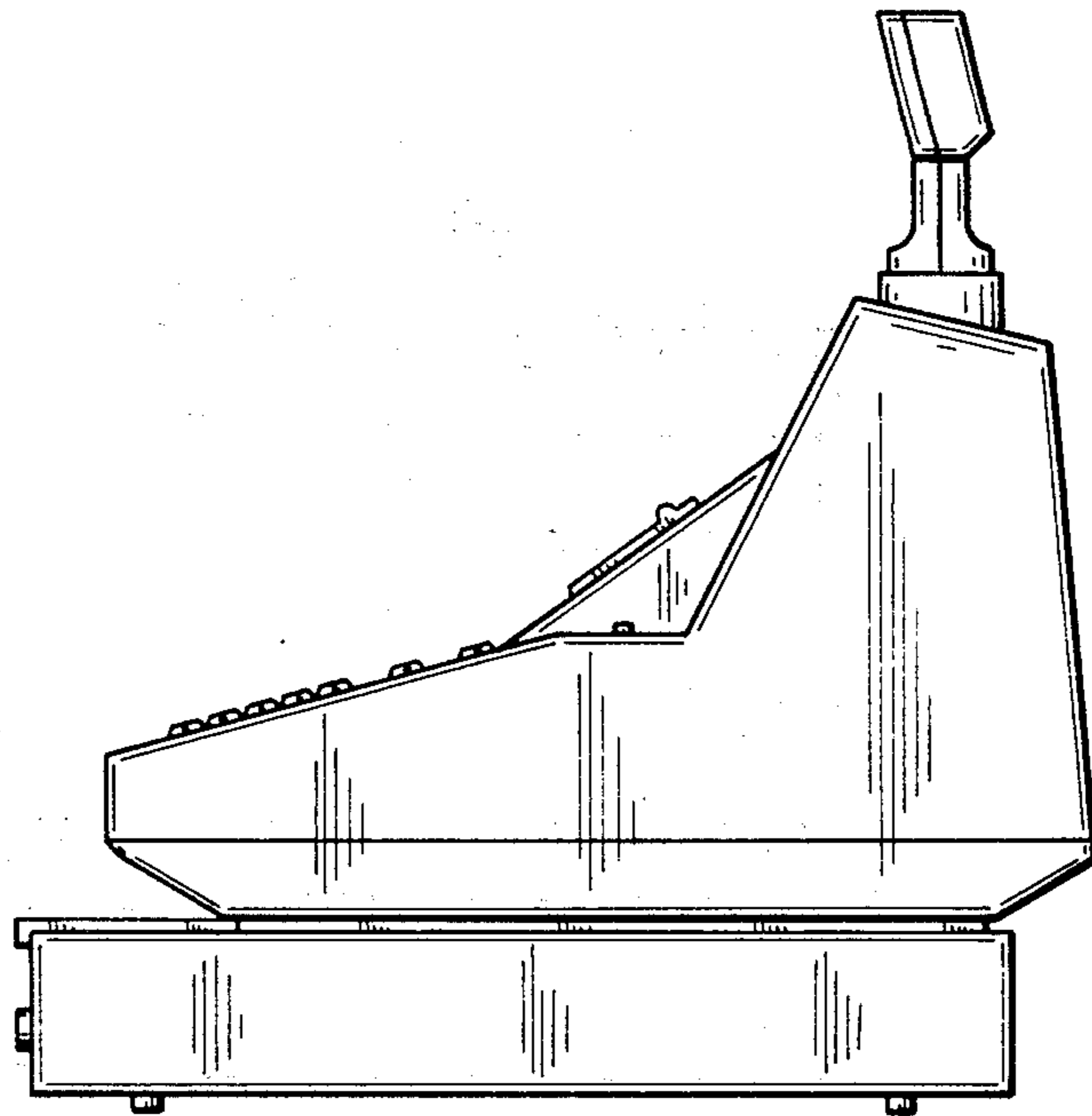

**FIG\_5**

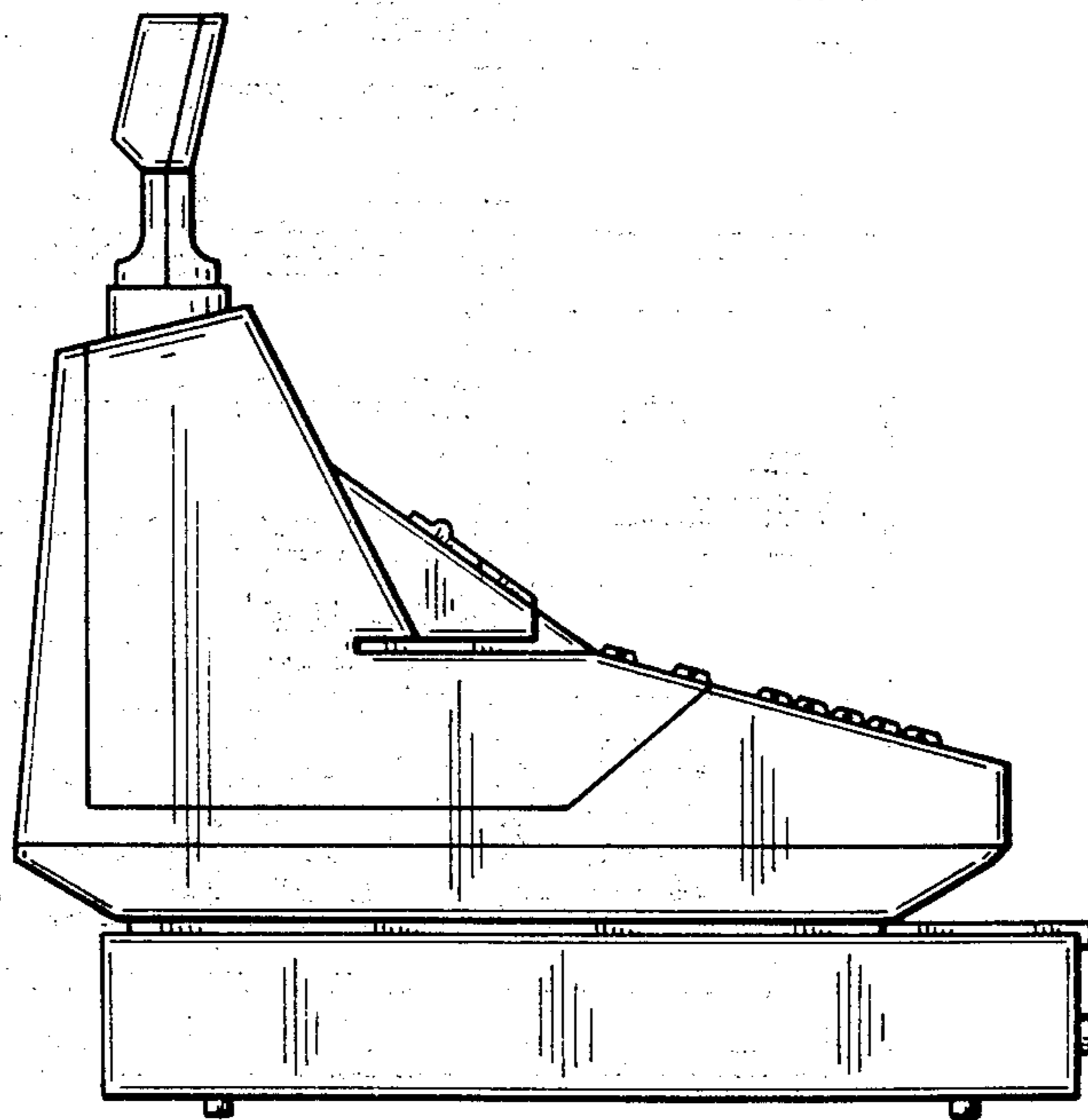

**FIG\_6**