

[54] **CORK EJECTOR**

[75] **Inventor: Fred A. Ravreby, Framingham, Mass.**

[73] **Assignee: Alon Products Inc., New York, N.Y.**

[**] **Term: 14 Years**

[21] **Appl. No.: 352,413**

[22] **Filed: Feb. 26, 1982**

[52] **U.S. Cl. D8/42**

[58] **Field of Search D8/33, 36, 40, 41, 42,
D8/43; 81/3, 2**

[56] **References Cited**

U.S. PATENT DOCUMENTS

D. 197,983 4/1964 Mourreau D8/42
D. 268,245 3/1983 Makino et al. D8/42
1,921,811 8/1933 Eger 81/3.2

3,192,803 7/1965 Federighi 81/3.2

Primary Examiner—Bernard Ansher
Assistant Examiner—Carmen H. Vales
Attorney, Agent, or Firm—Millen & White

[57] **CLAIM**

The ornamental design for a cork ejector, substantially as shown and described.

DESCRIPTION

FIG. 1 is a top perspective view of a cork ejector showing my new design;

FIG. 2 is a bottom perspective view thereof;

FIG. 3 is a left side elevational view; the right side being a mirror image thereof;

FIG. 4 is a front elevational view thereof;

FIG. 5 is a rear elevational view thereof;

FIG. 6 is a top plan view thereof; and

FIG. 7 is a bottom plan view thereof.

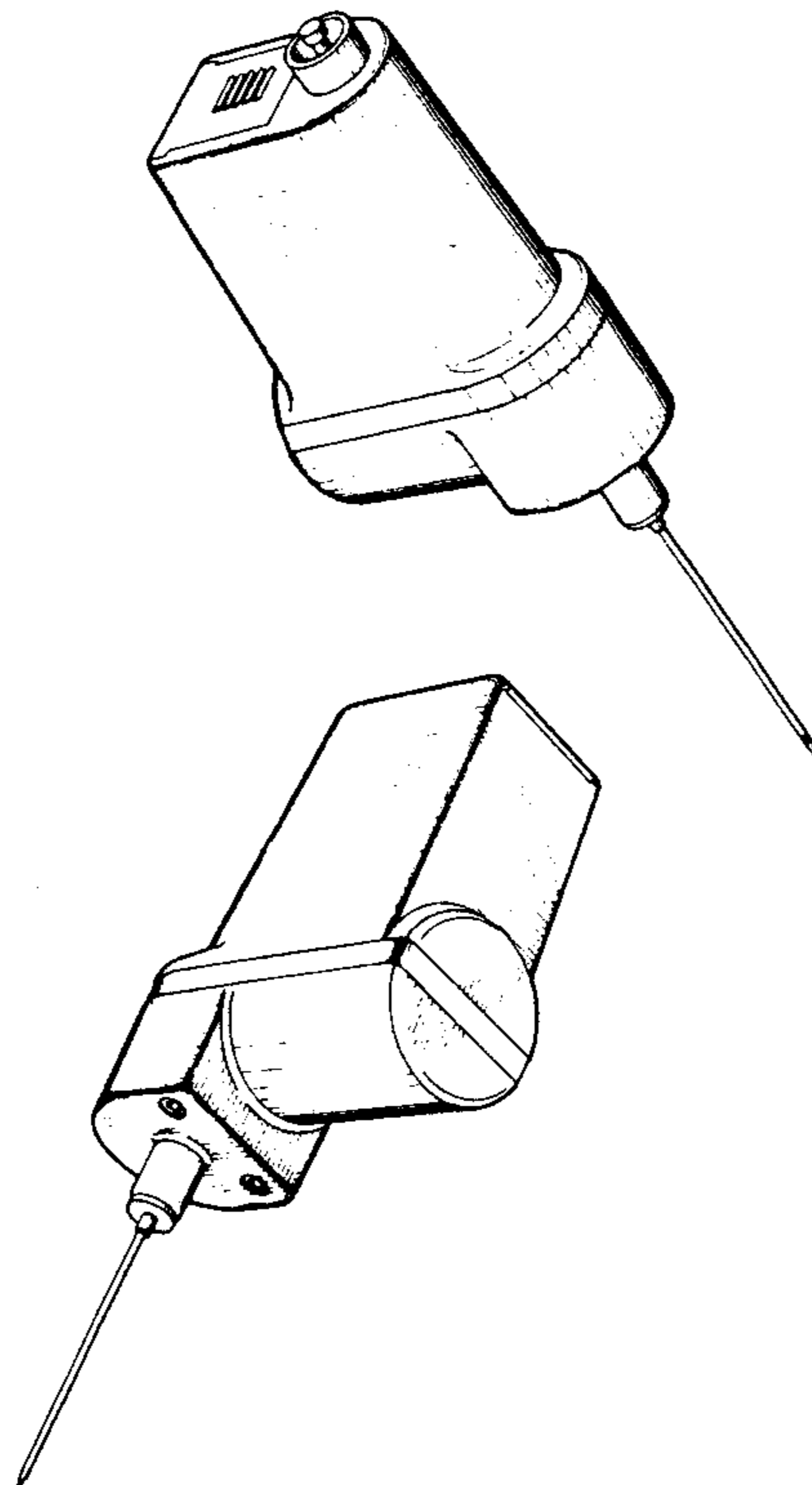

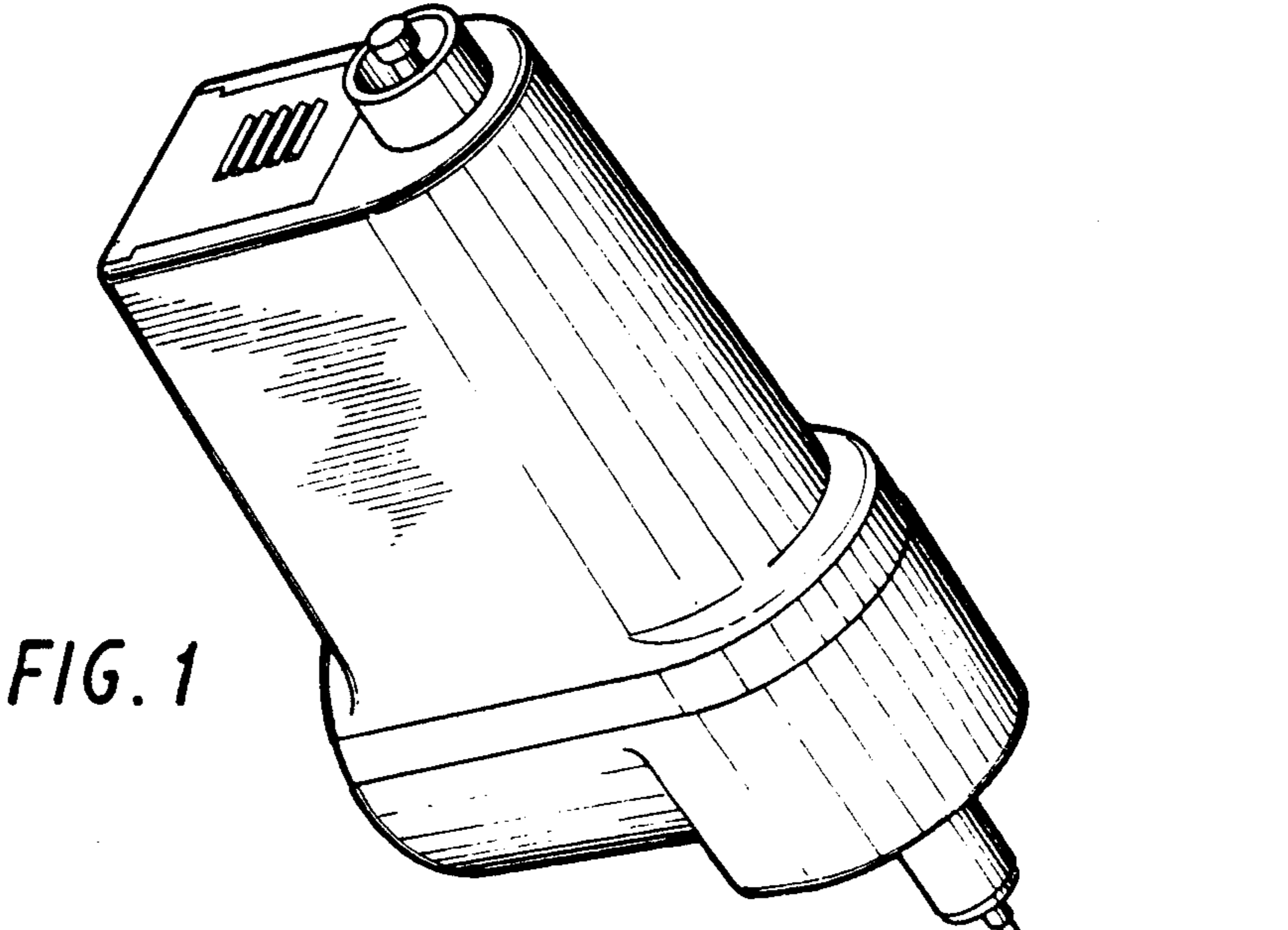

FIG. 1

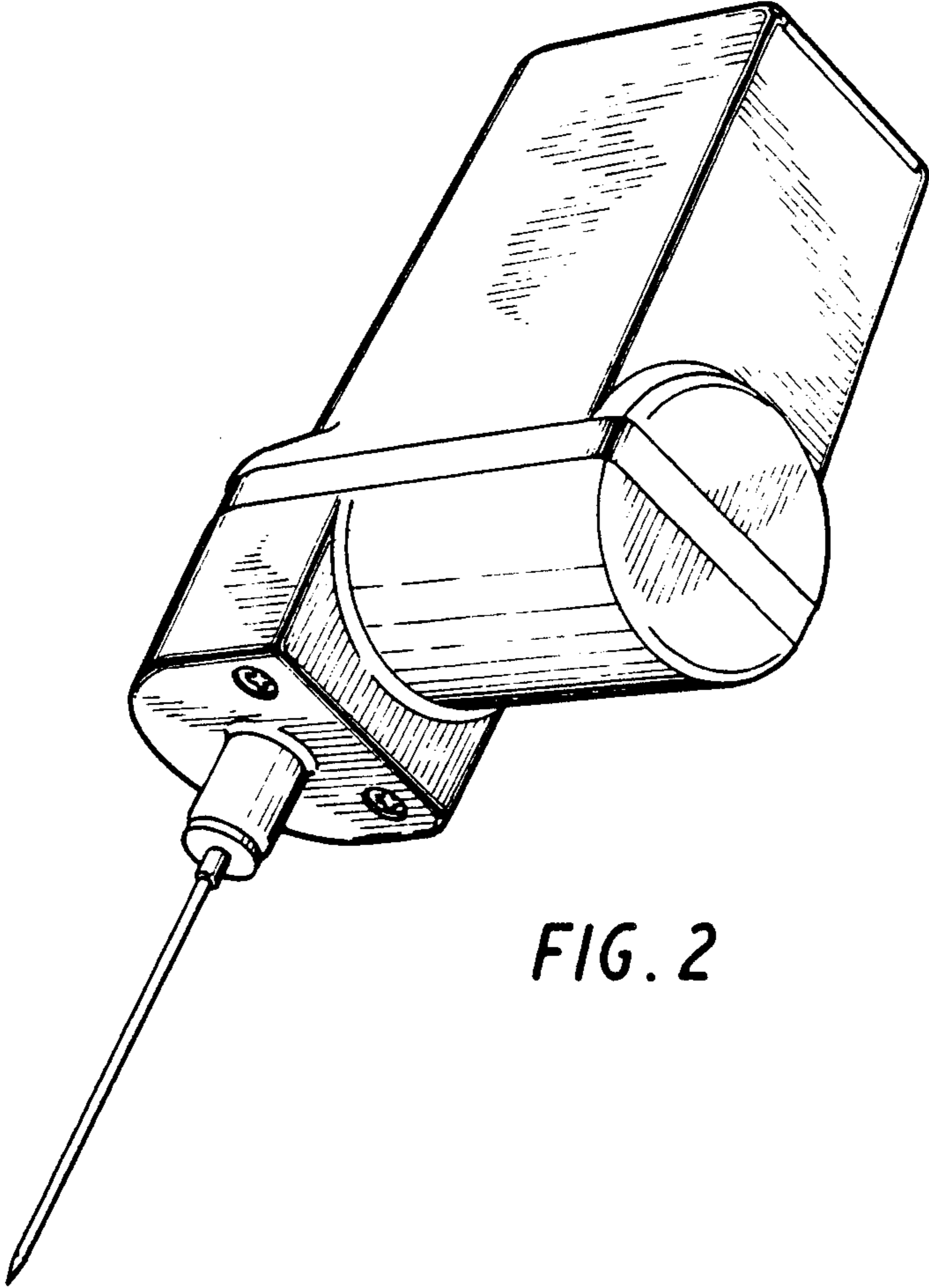

FIG. 2

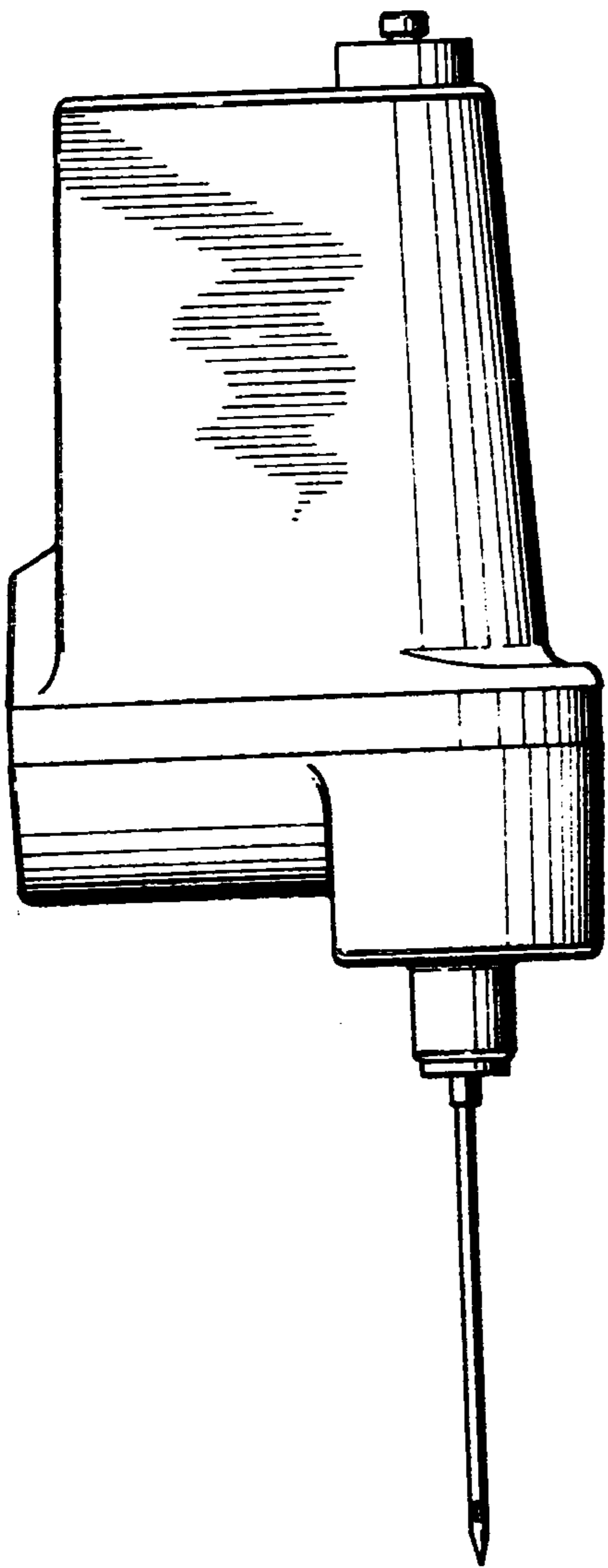

FIG. 3



FIG. 4

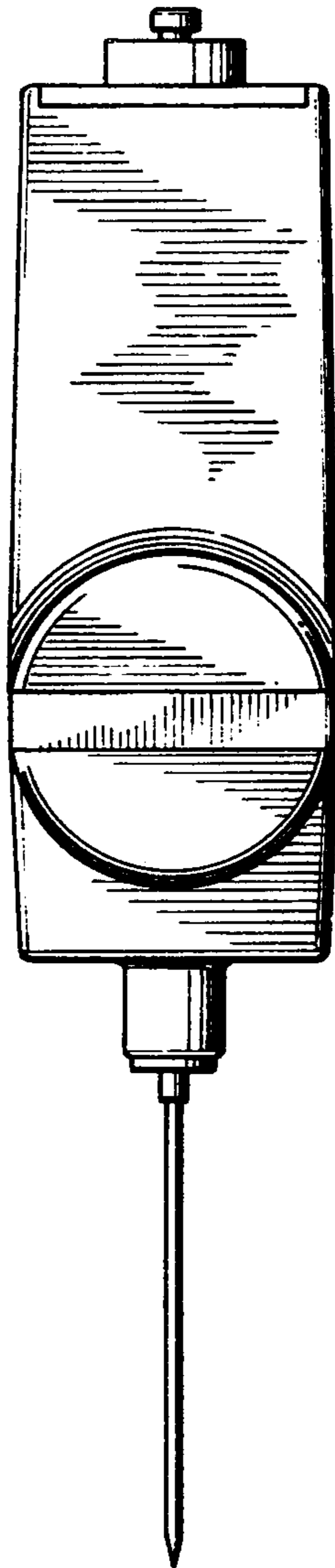

FIG. 5

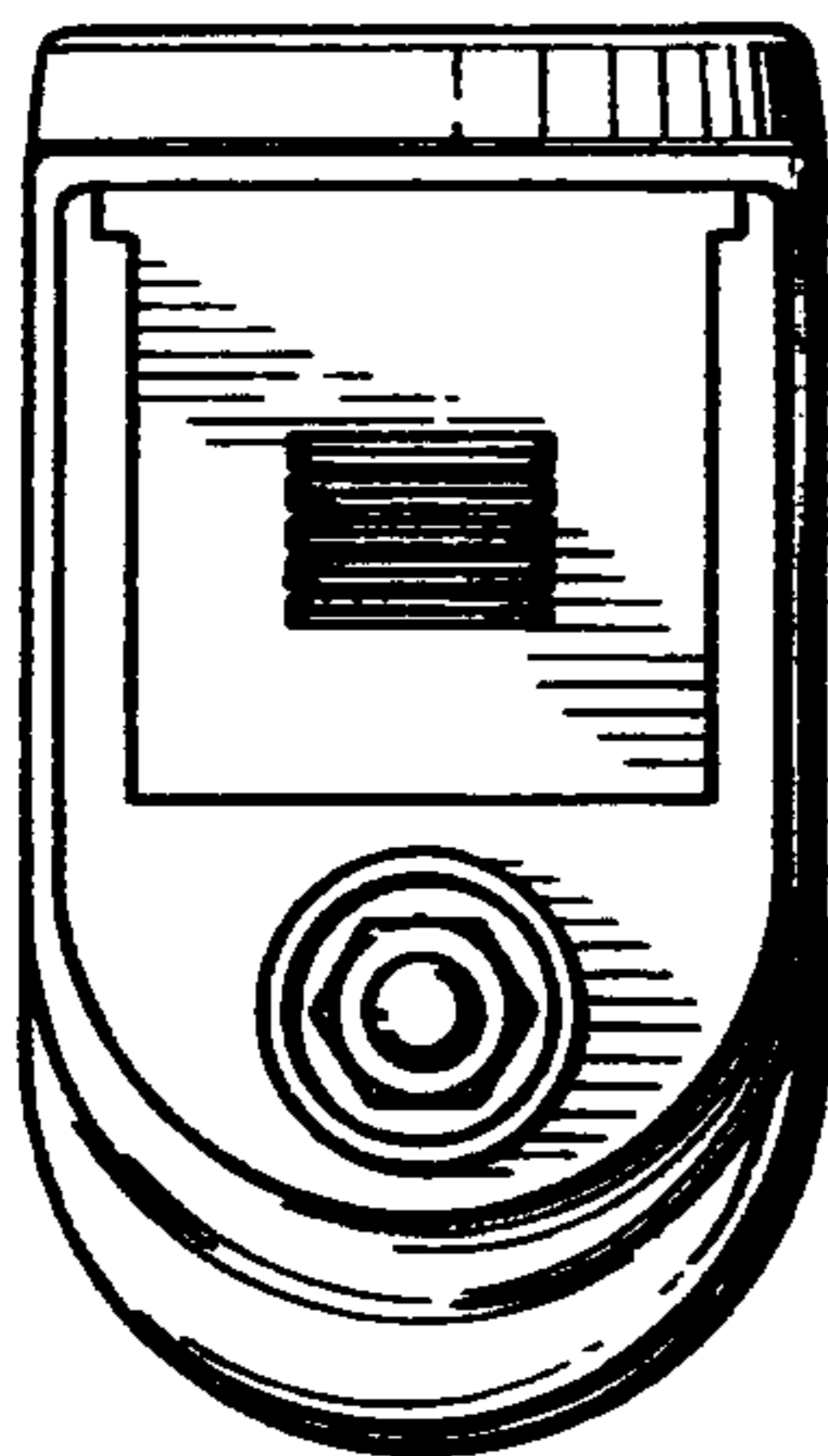

FIG. 6

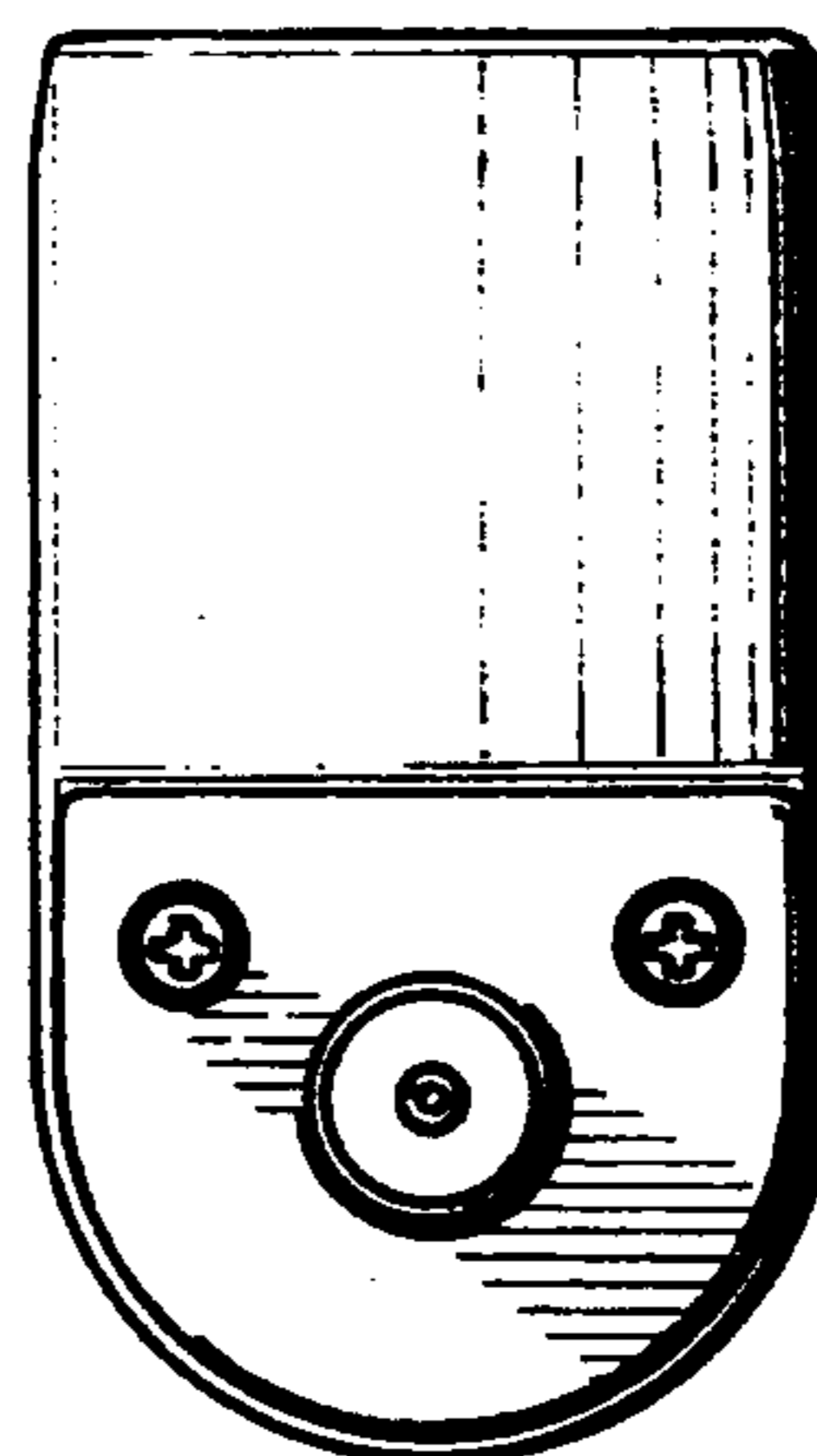

FIG. 7