

[54] OTTOMAN

[75] Inventor: Vittorio Livi, Pesaro, Italy

[73] Assignee: FIAM S.r.l., Italy

[**] Term: 14 Years

[21] Appl. No.: 244,632

[22] Filed: Mar. 17, 1981

[52] U.S. Cl. D6/349; D6/355; D6/485

[58] Field of Search D6/58, 32, 36, 175, D6/177, 179; 108/150, 153

[56] References Cited

U.S. PATENT DOCUMENTS

4,321,875 3/1982 Danko 108/150

OTHER PUBLICATIONS

Interiors, May 1979, p. 24, ottoman right center by design Tex.

Industrial Design, Dec. 1969, p. 58, table at center by Schickel.

Office Products, Oct. 1975, p. 56, table top left by Howe Furn. Co.

Primary Examiner—Bruce W. Dunkins
Attorney, Agent, or Firm—Darby & Darby

[57] CLAIM

The ornamental design for an ottoman, as shown and described.

DESCRIPTION

FIG. 1 is a perspective view of an ottoman showing my design;

FIG. 2 is an elevational view of one of the two identical sides;

FIG. 3 is a top plan view;

FIG. 4 is an elevational view of one of the two identical ends; and

FIG. 5 is a bottom plan view thereof;

FIG. 6 is a perspective view of a second embodiment of the ottoman shown in FIG. 1;

FIG. 7 is an elevational view of one of the two identical sides;

FIG. 8 is a top plan view;

FIG. 9 is an elevational view of one of the two identical ends; and

FIG. 10 is a bottom plan view thereof.

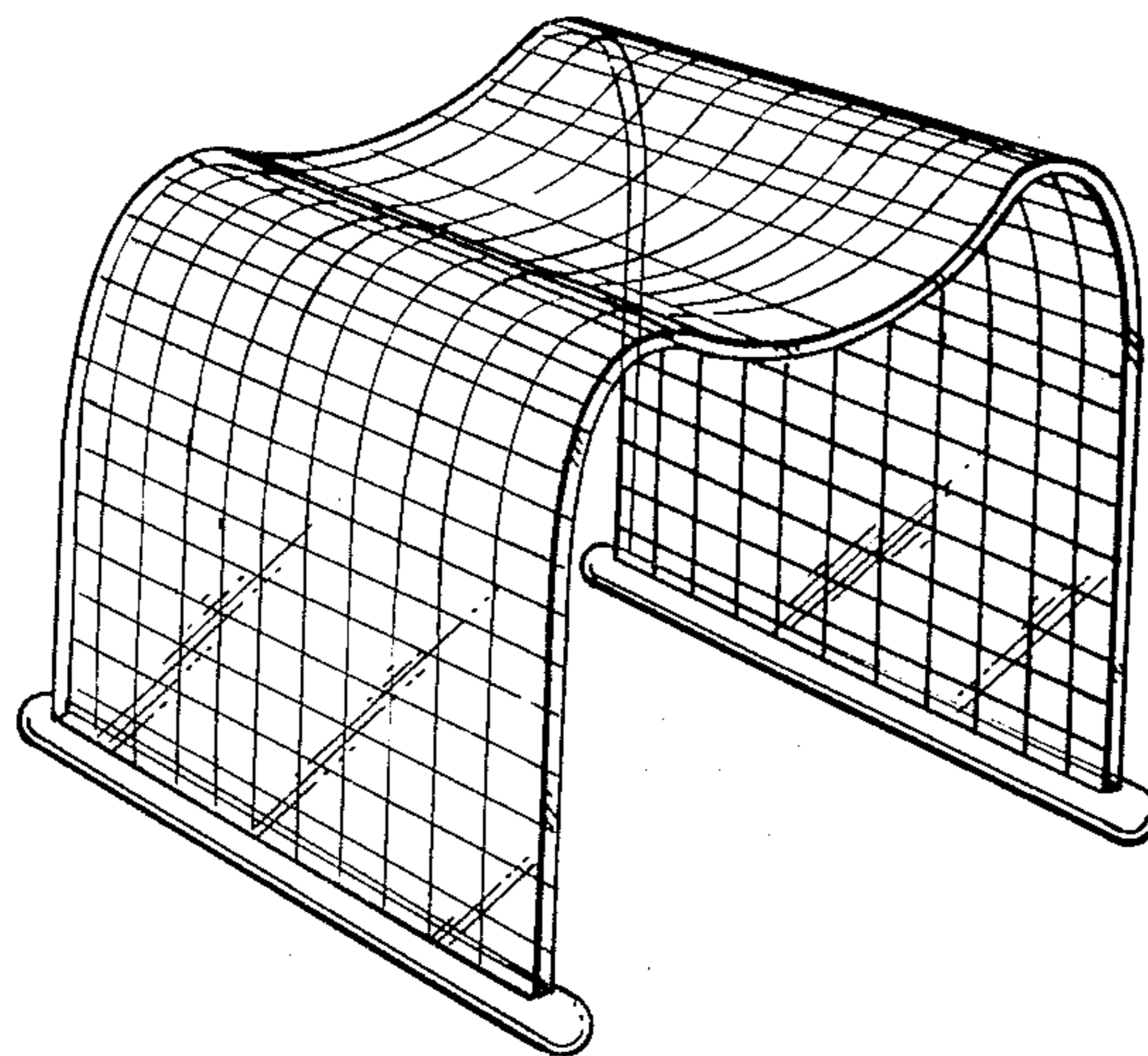

FIG. 1

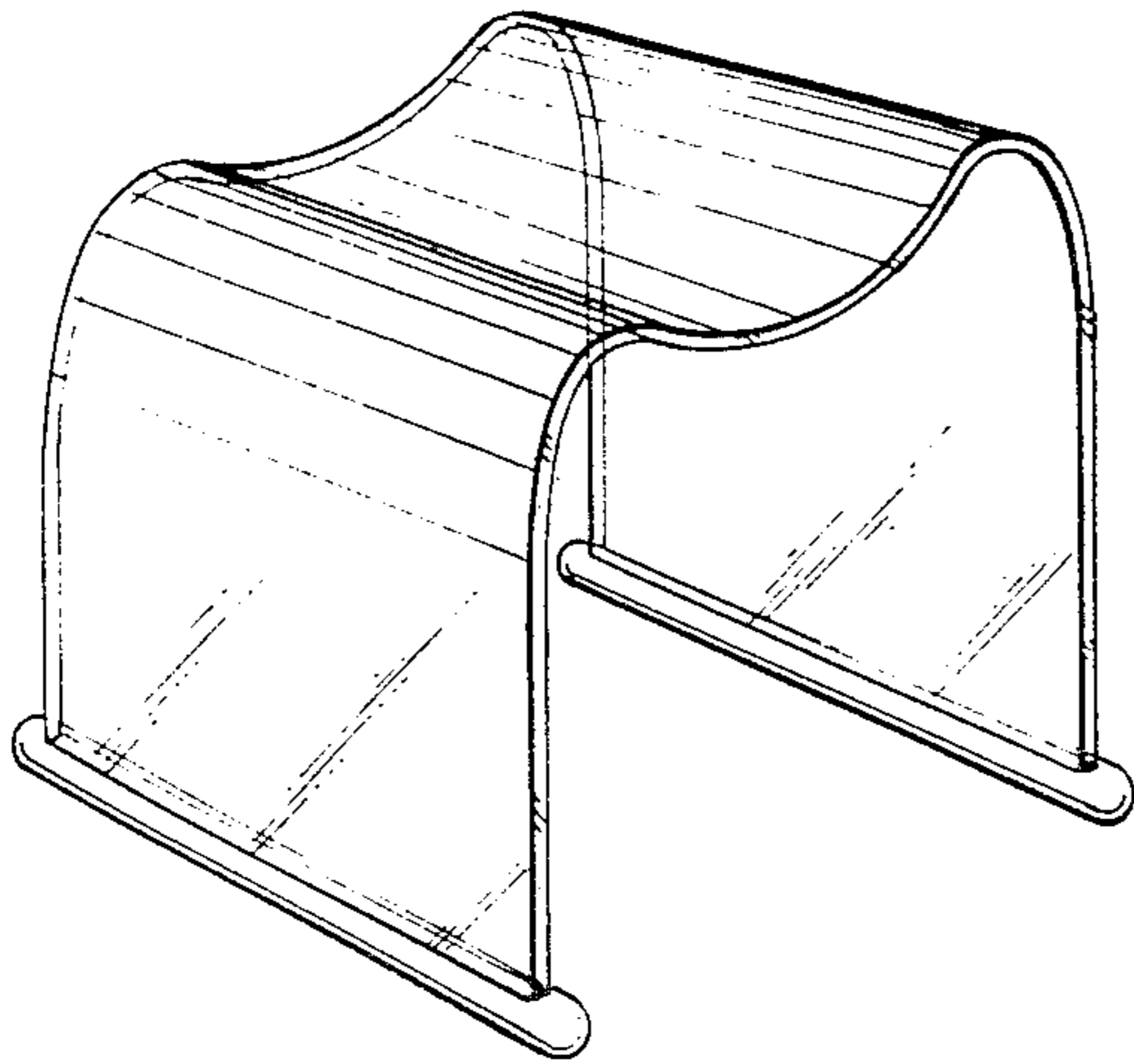

FIG. 2

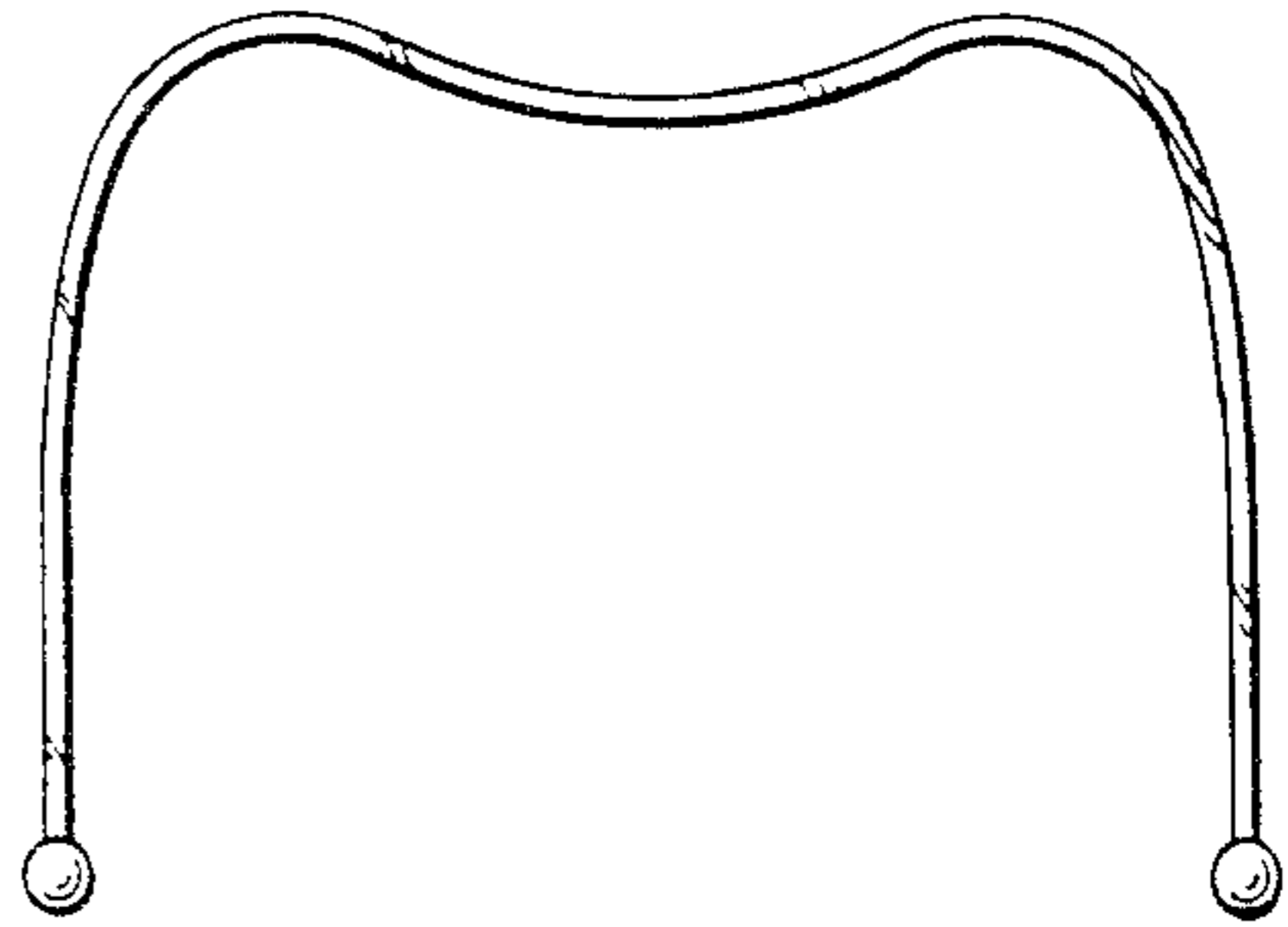

FIG. 3

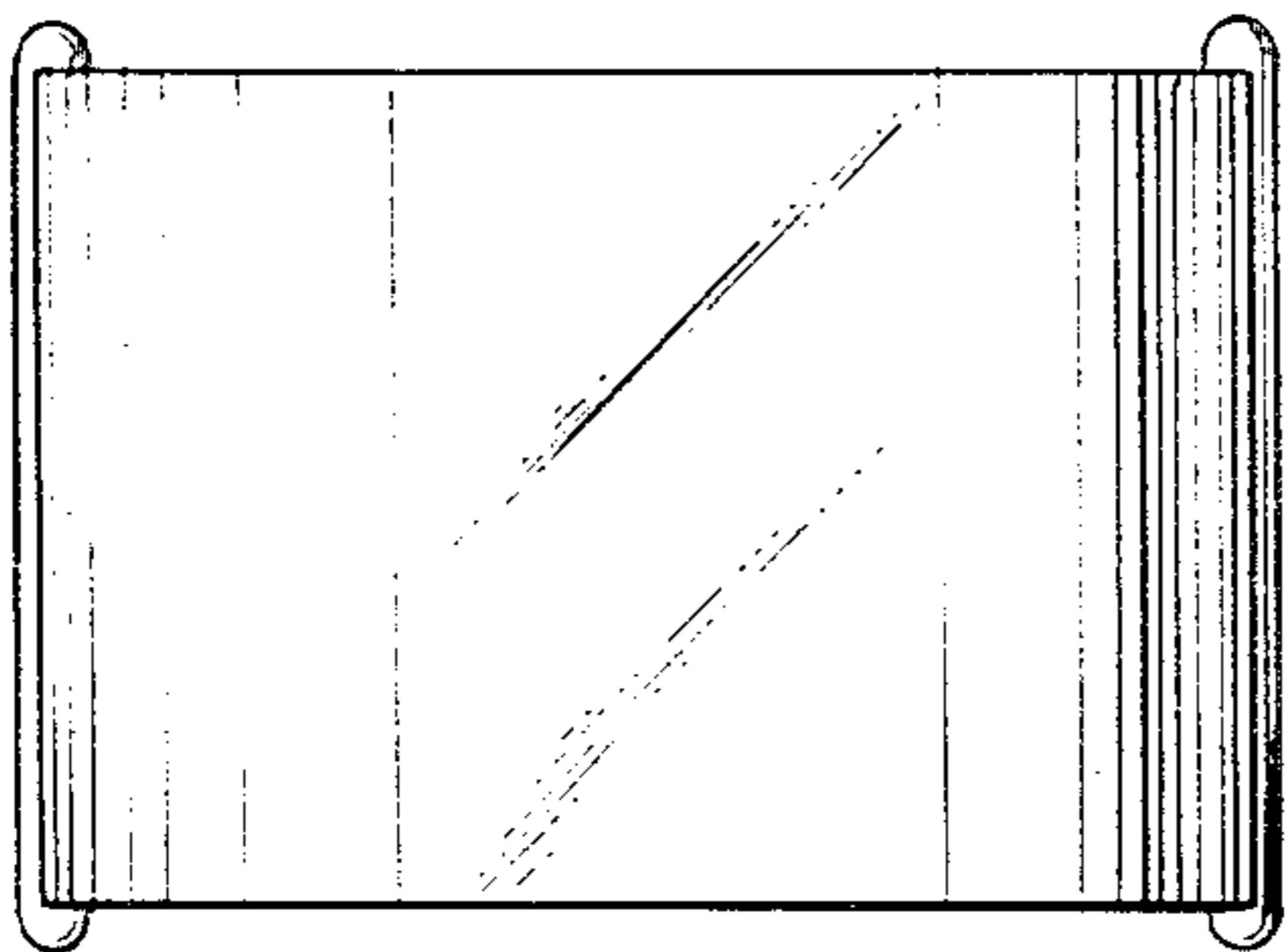

FIG. 4

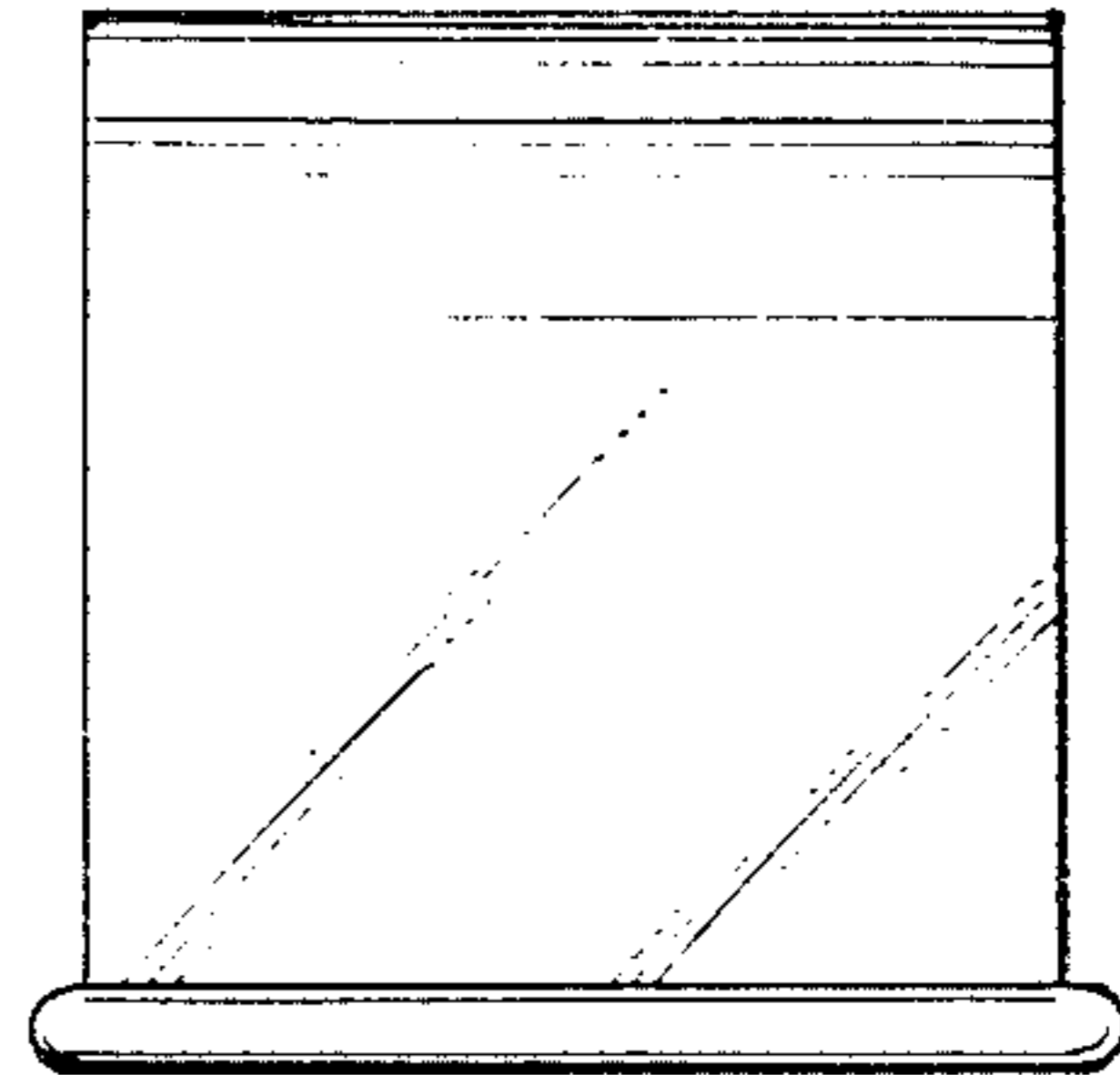

FIG. 5

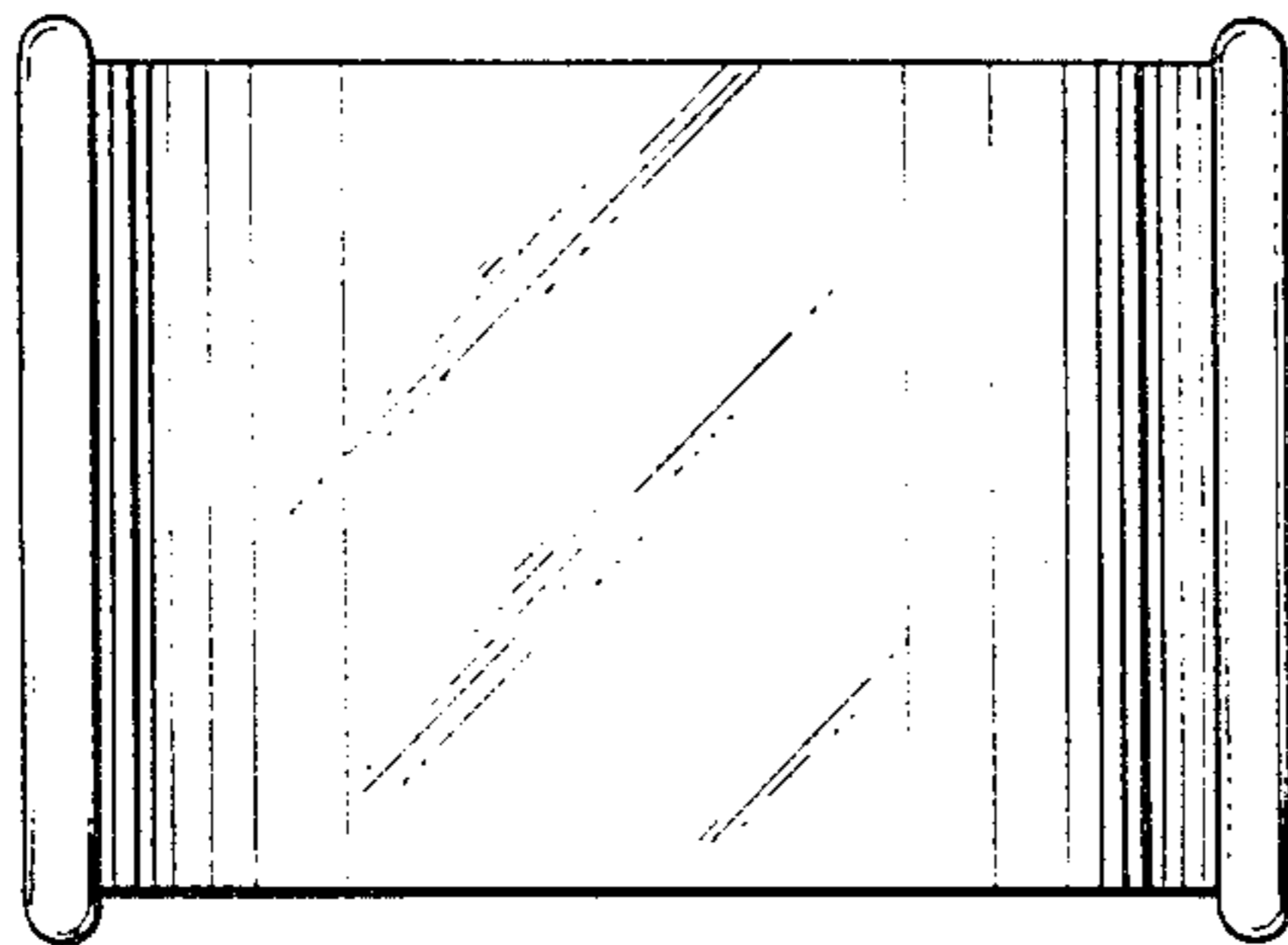

FIG. 6

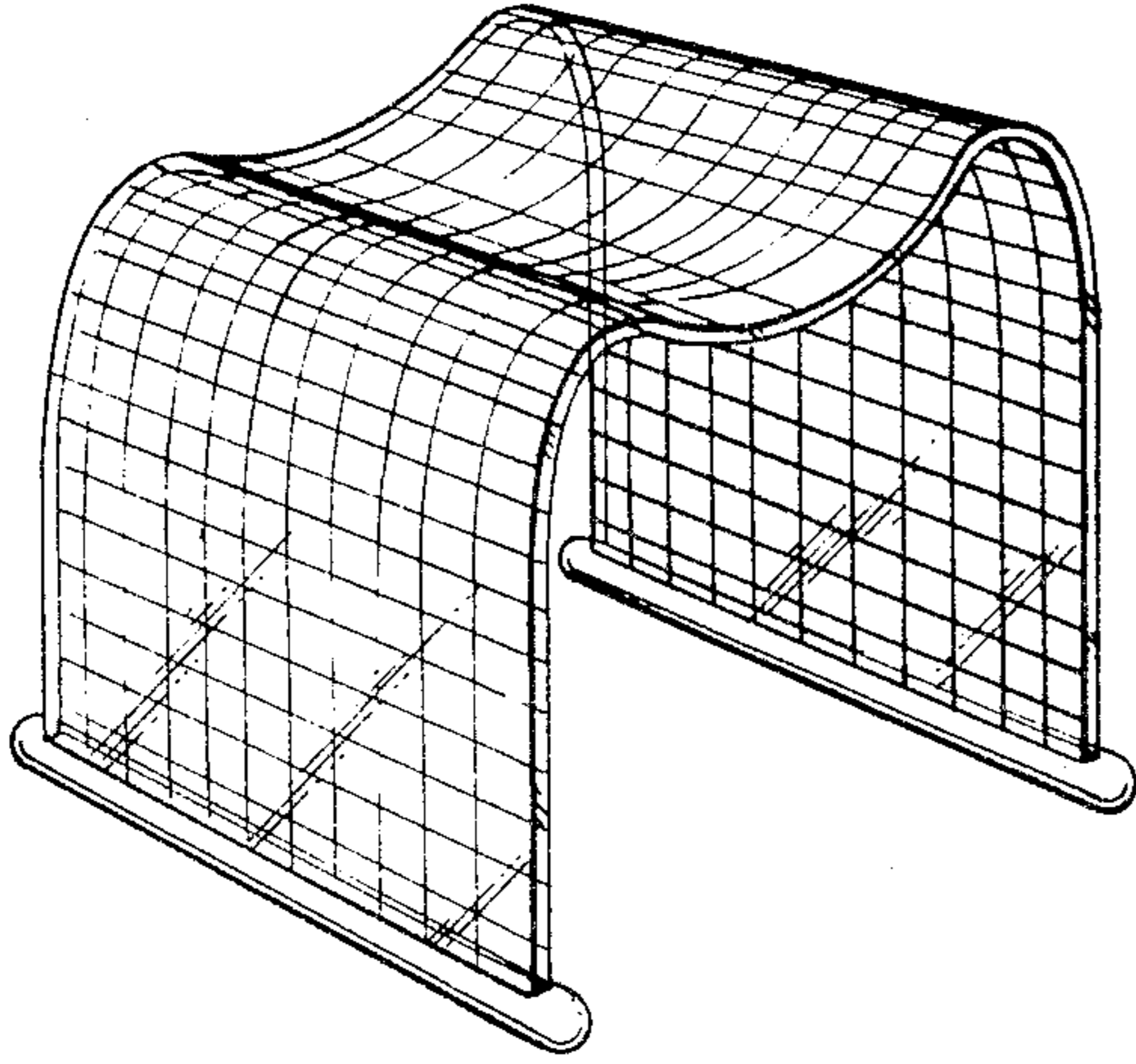

FIG. 7

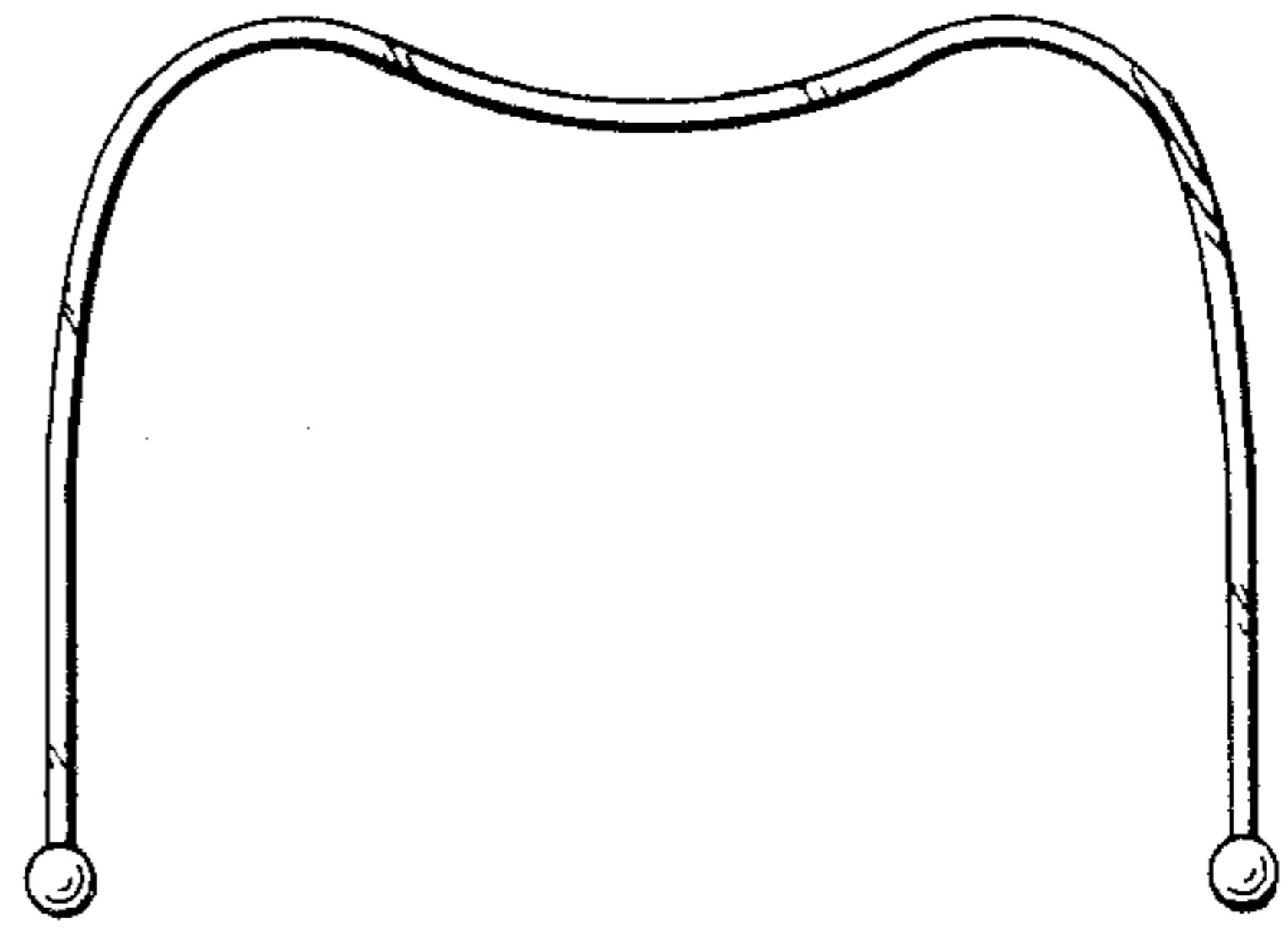

FIG. 8

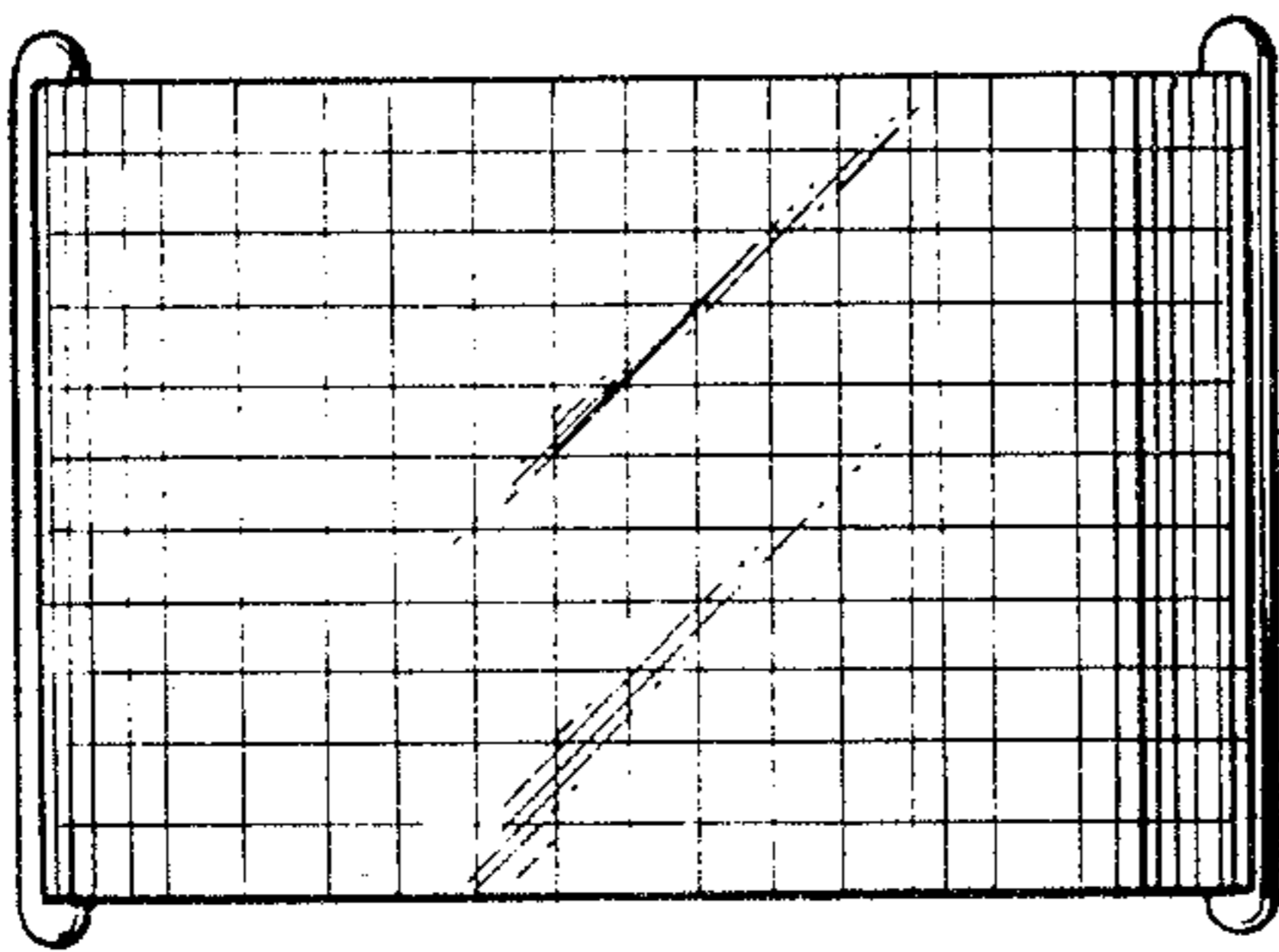

FIG. 9

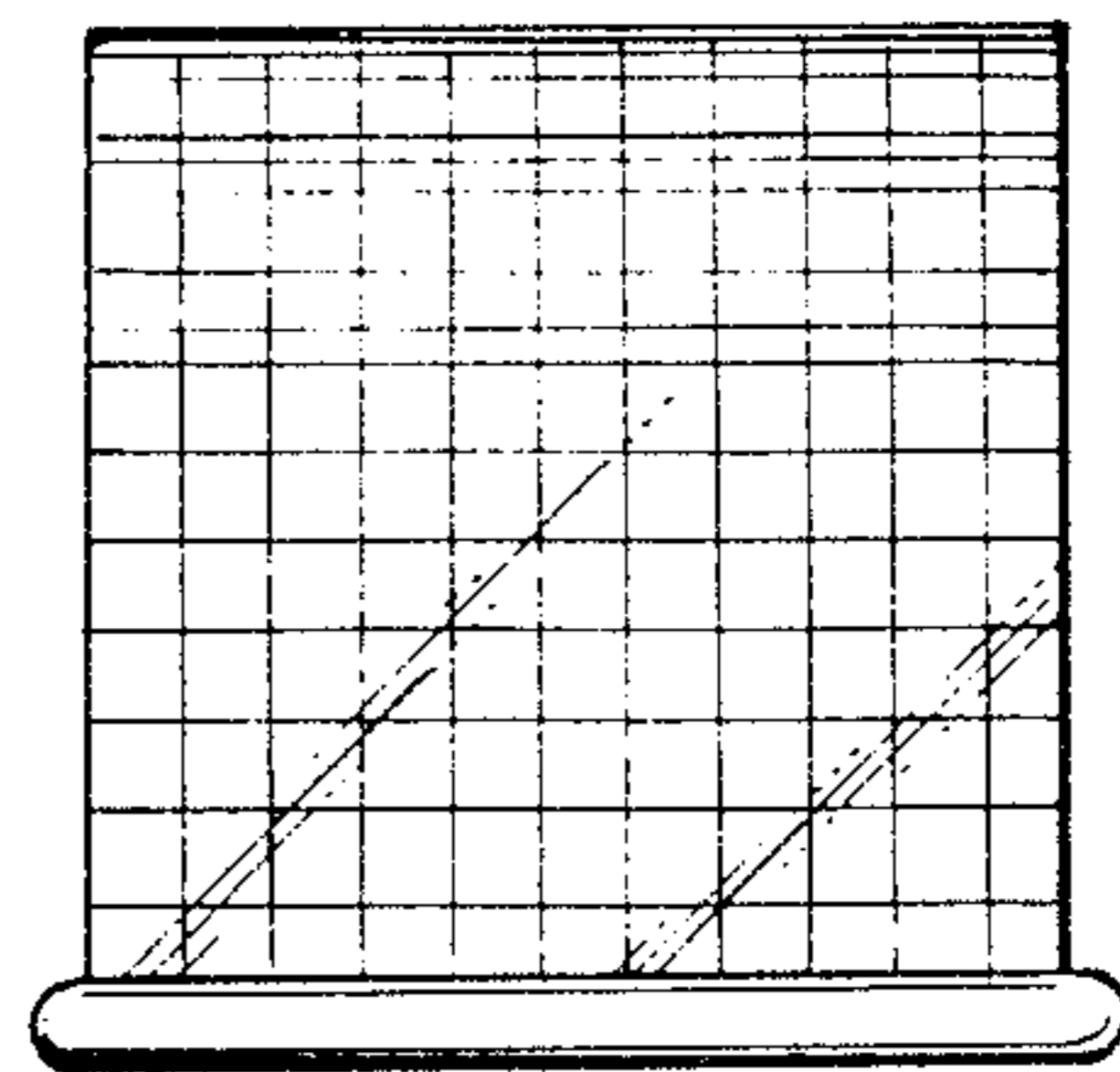

FIG. 10

