

[54] PET CARRIER FOR A BICYCLE OR THE LIKE

4,026,448 5/1977 Lewis ..... 224/32 A  
4,030,648 6/1977 Johnson et al. .... 224/32 A

[76] Inventor: Hilary Schacter, 228 Comanche Dr., Oceanport, N.J. 17757

FOREIGN PATENT DOCUMENTS

85012 12/1935 Sweden ..... 224/32 A

[\*\*] Term: 14 Years

Primary Examiner—James R. Largen  
Attorney, Agent, or Firm—Lerner, David, Littenberg, Krumholz & Mentlik

[21] Appl. No.: 421,365

[22] Filed: Sep. 22, 1982

[52] U.S. Cl. .... D12/158; D30/41; D30/99

[57] CLAIM

The design for a pet carrier for a bicycle or the like, substantially as shown and described.

[58] Field of Search ..... D30/1-5, D30/41, 42, 99; 119/1, 19; D12/158; 224/324

DESCRIPTION

[56] References Cited

U.S. PATENT DOCUMENTS

- D. 229,922 1/1974 Bishaf et al. .... D12/158
- D. 233,517 11/1974 Girvin ..... D12/158
- D. 245,716 9/1977 Russo ..... D30/41
- D. 260,757 9/1981 Garra et al. .... D12/158
- 3,465,930 9/1969 La Croix ..... 119/1
- 3,625,405 12/1971 Kezar et al. .... 224/32 A

FIG. 1 is a perspective view of a pet carrier for a bicycle or the like showing my new design; FIG. 2 is a right side elevational view thereof the left side being a mirror image of the right side shown; FIG. 3 is a rear elevational view thereof; FIG. 4 is a front elevational view thereof; FIG. 5 is a top plan view thereof; and FIG. 6 is a bottom plan view thereof with the ties omitted for convenience of illustration.

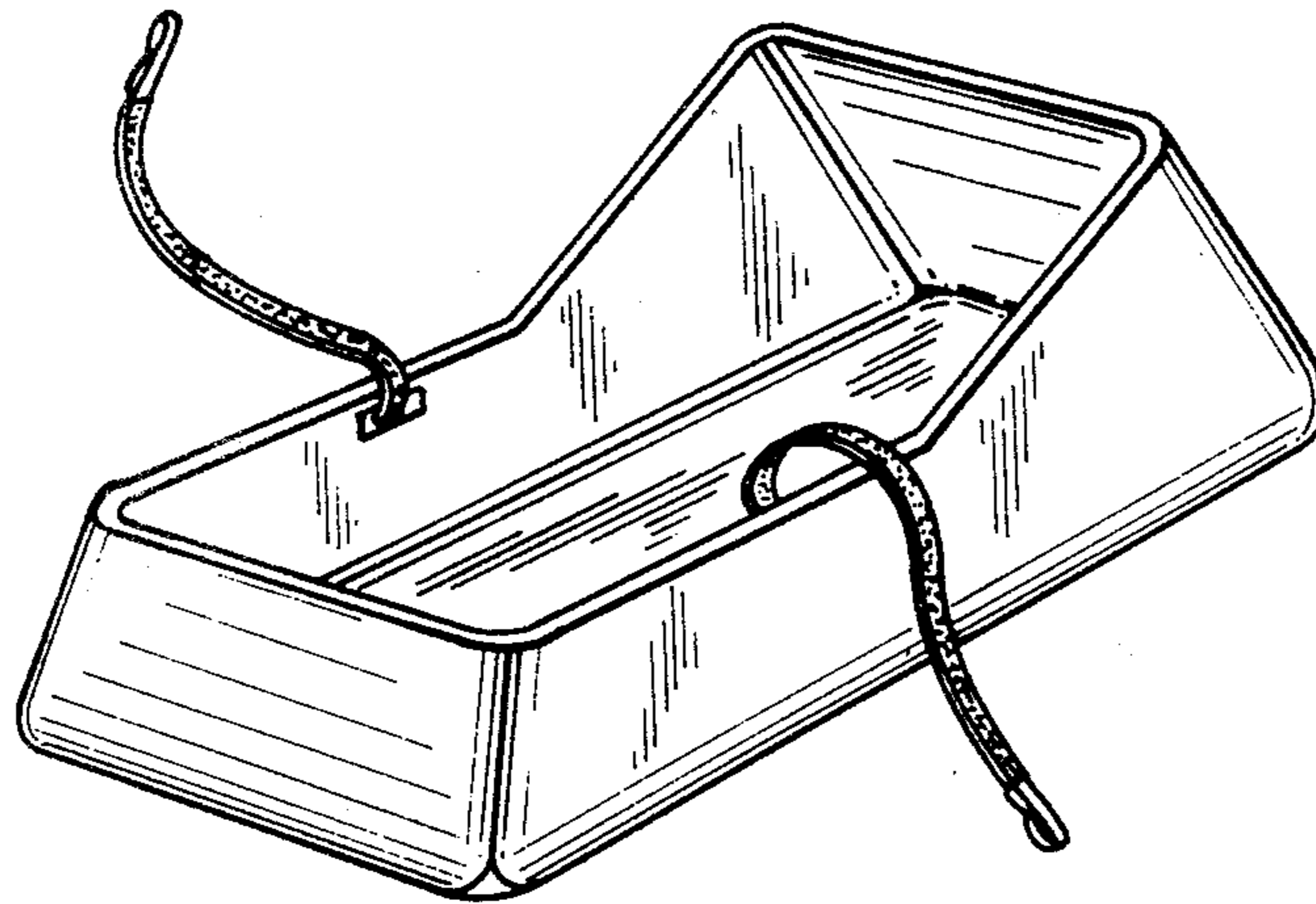

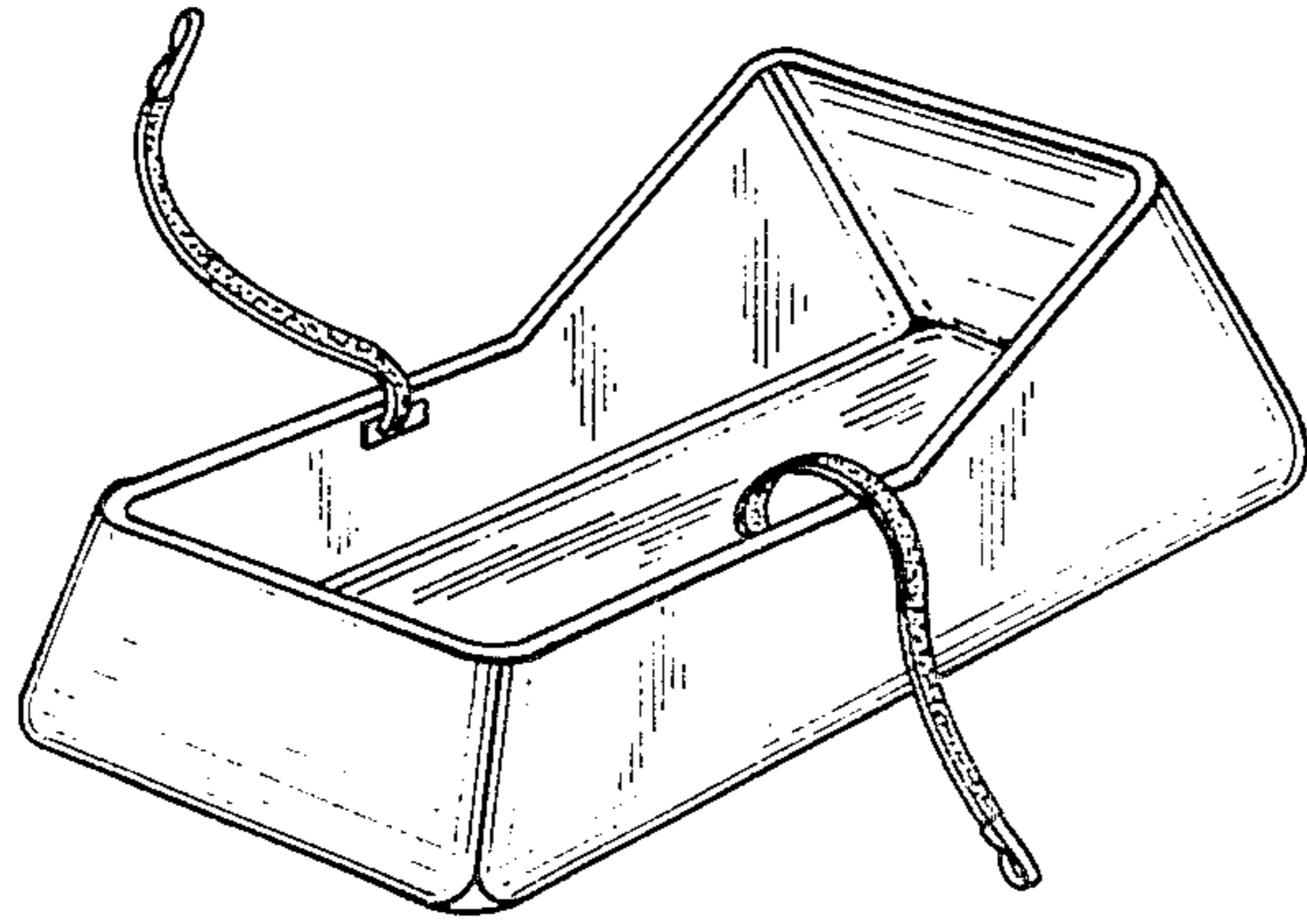

FIG. 1

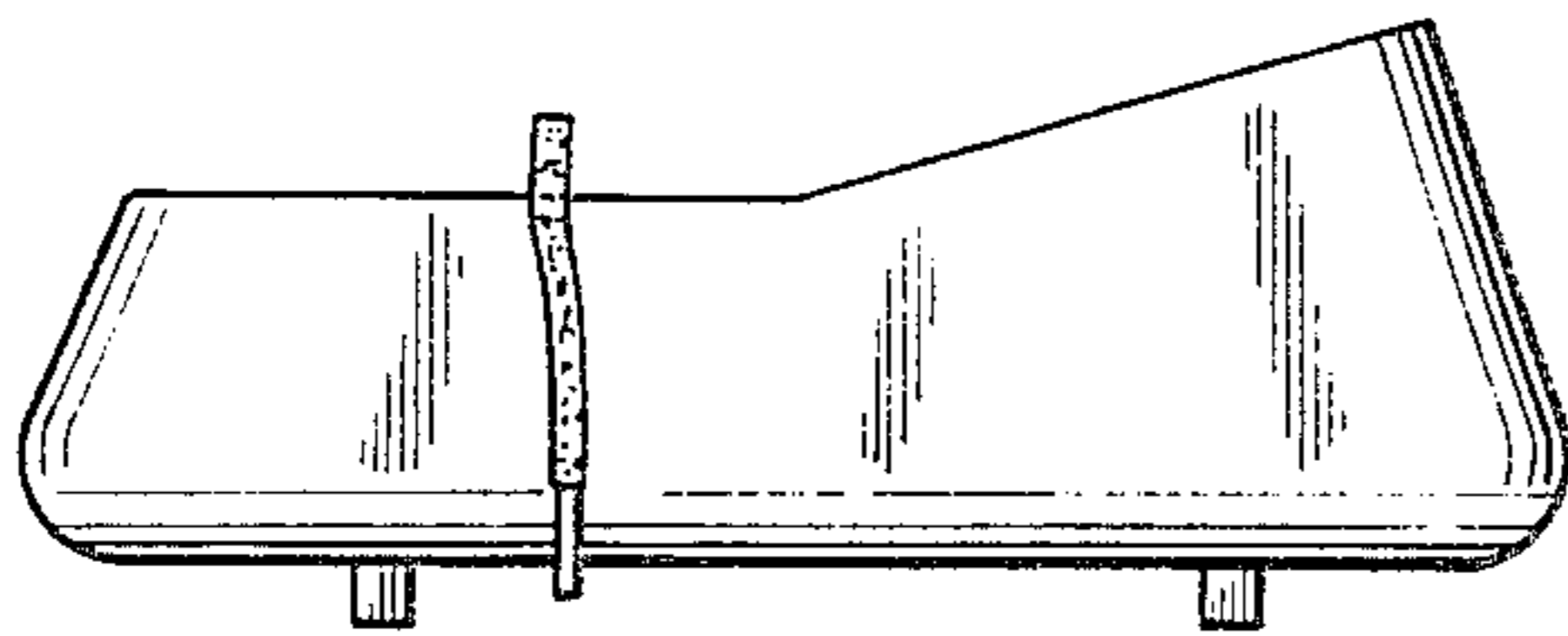

FIG. 2

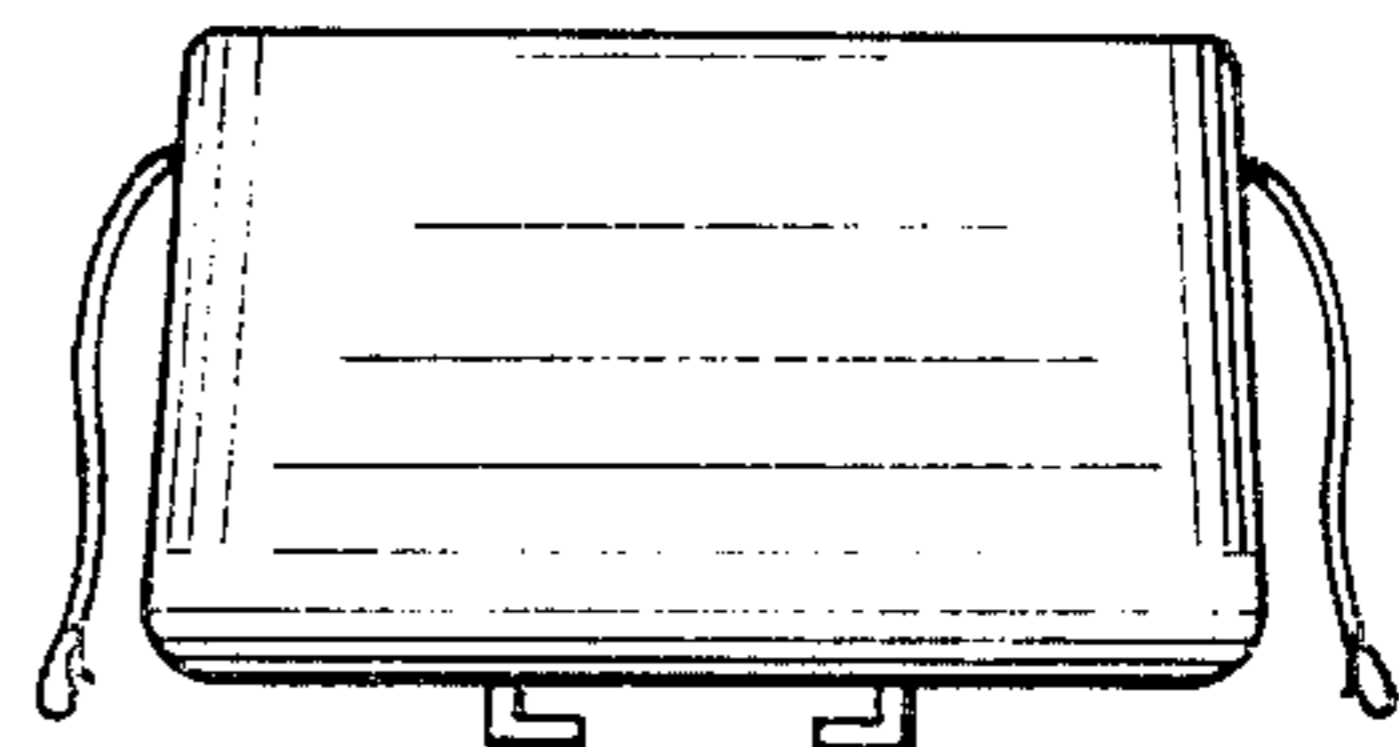

FIG. 3

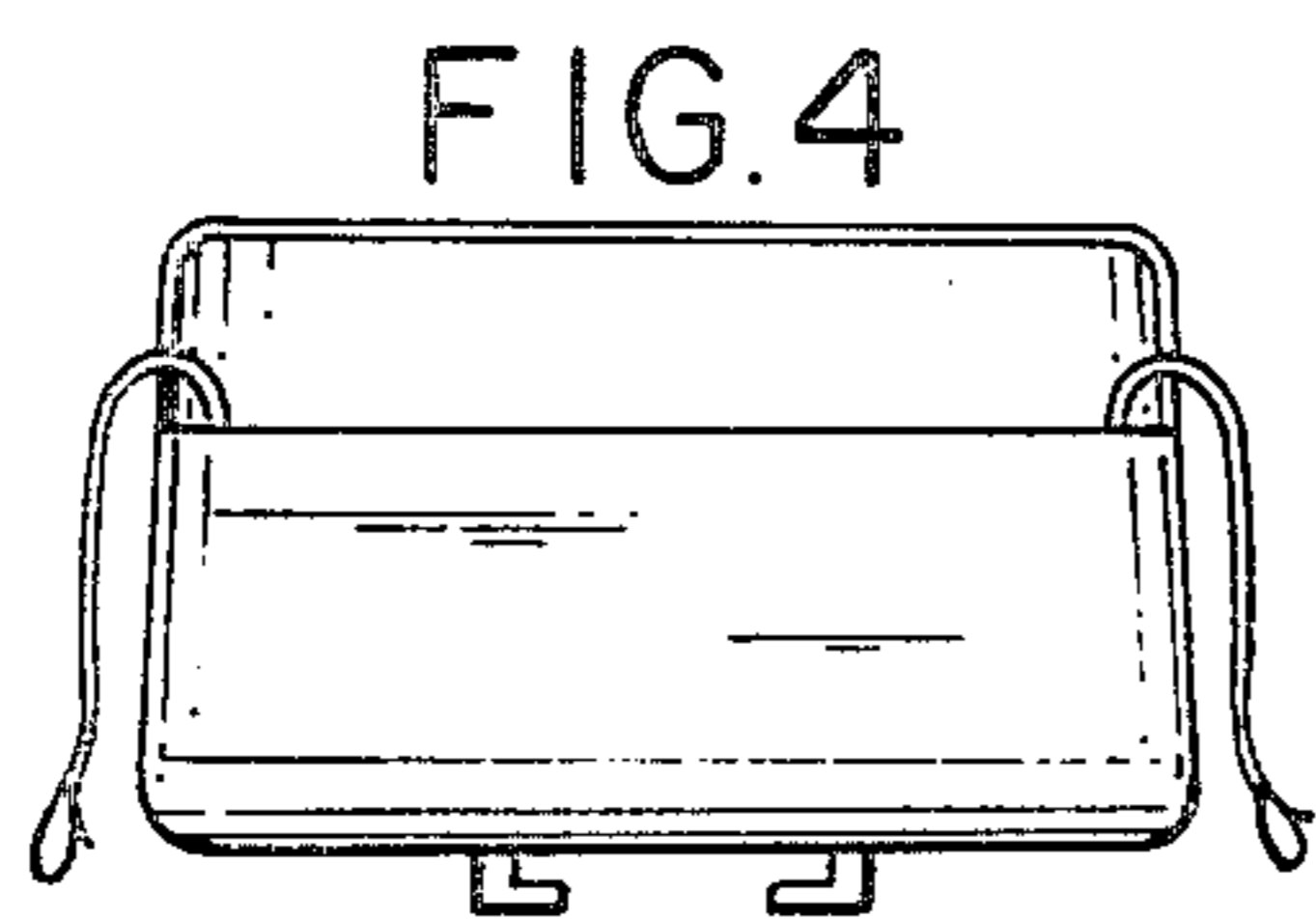

FIG. 4

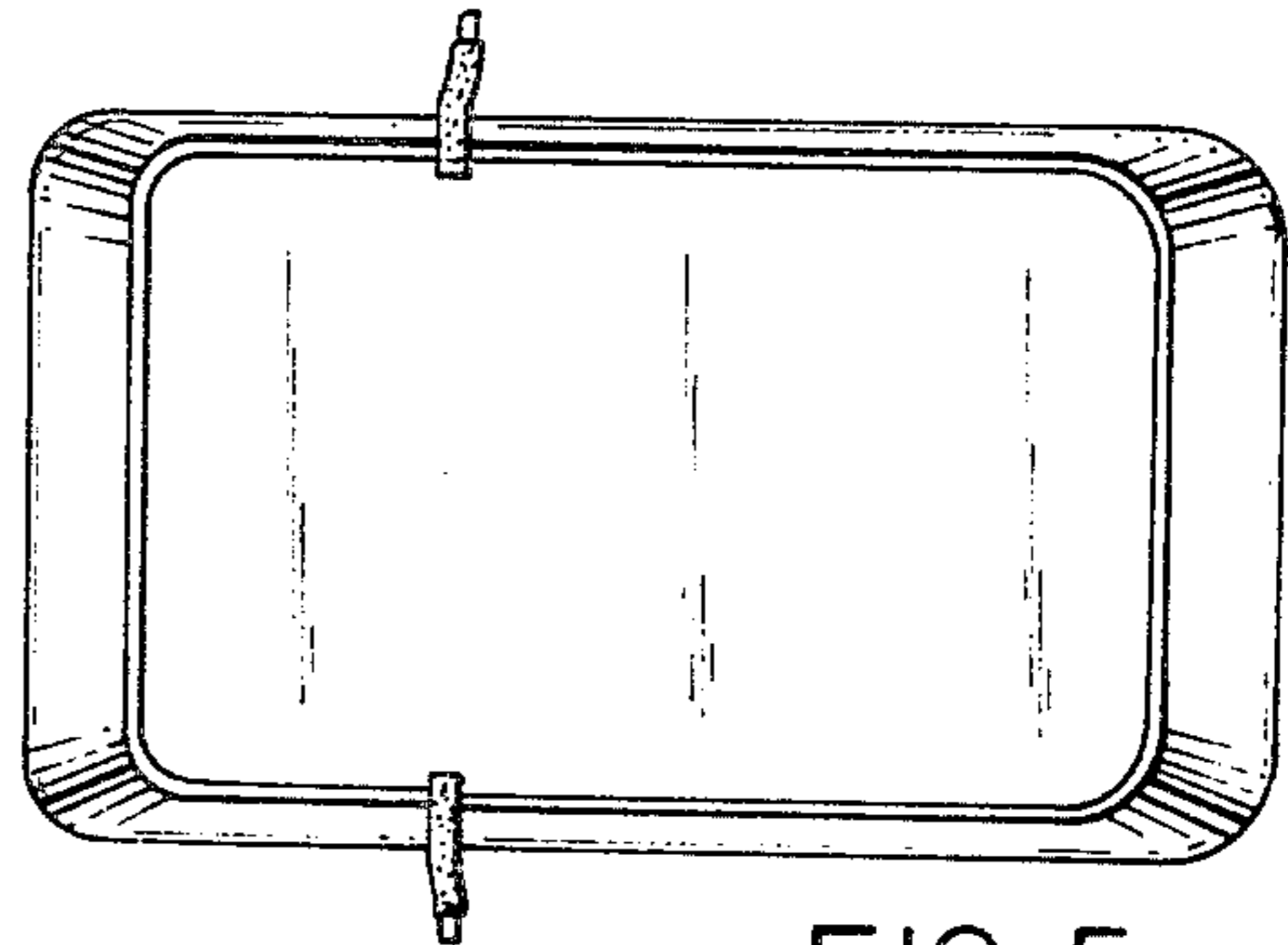

FIG. 5

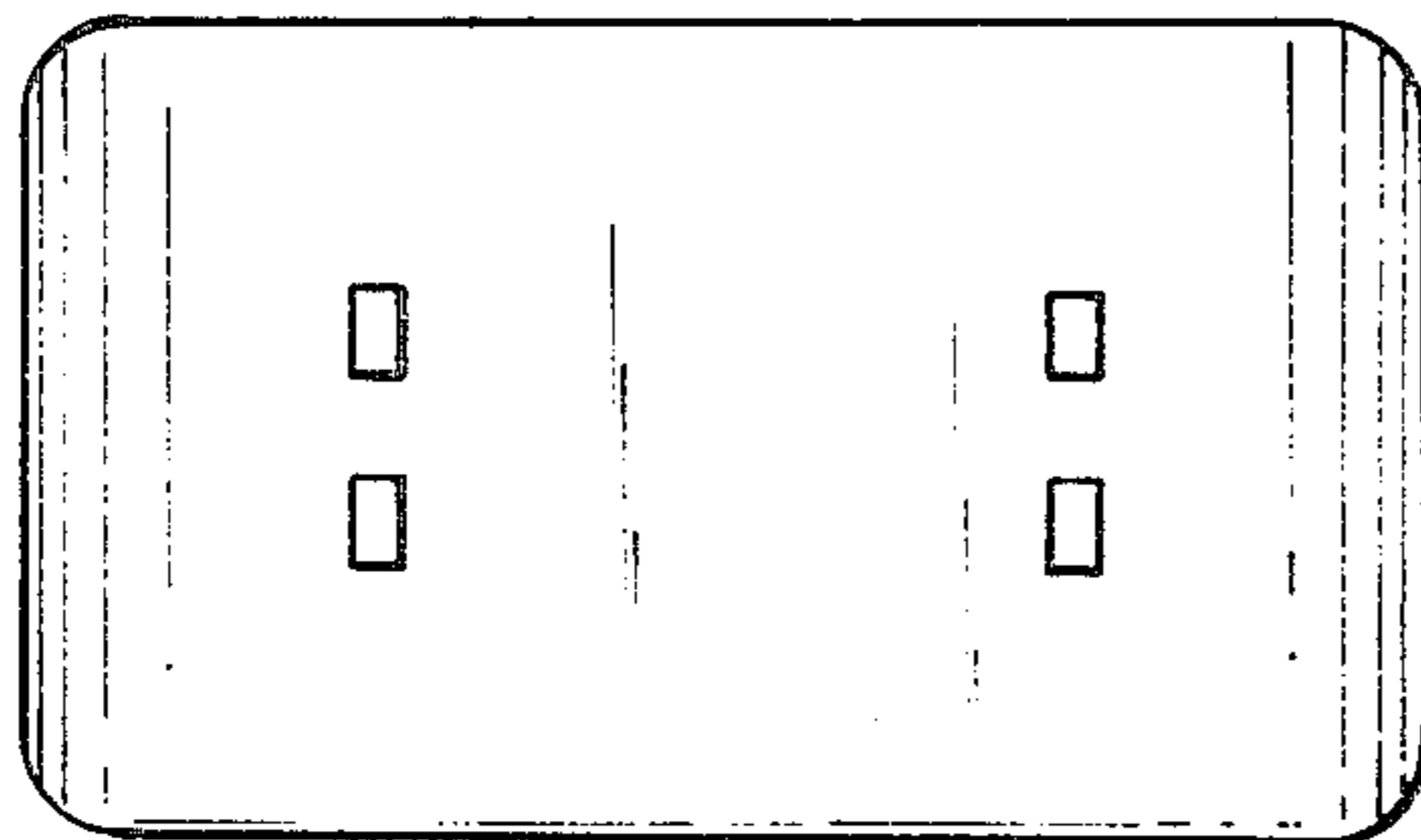

FIG. 6