

United States Patent [19]

Fitch

[11] Patent Number: **Des. 276,577**

[45] Date of Patent: **** Dec. 4, 1984**

[54] **FLOTABLE LOUNGE CHAIR OR SIMILAR ARTICLE**

[76] Inventor: **Craig H. Fitch**, 12100 Mellow Wood Dr., Saratoga, Calif. 95070

[**] Term: **14 Years**

[21] Appl. No.: **300,267**

[22] Filed: **Sep. 8, 1981**

[52] U.S. Cl. **D6/361**

[58] Field of Search **D6/1, 4, 37-39, D6/67, 79, 80, 200, 201, 197**

[56] **References Cited**

U.S. PATENT DOCUMENTS

- D. 220,953 6/1971 Des Pres D6/37
- D. 230,237 2/1974 Beach et al. D6/197

- D. 247,938 5/1978 Rankin D6/67 X
- 3,408,107 10/1968 Savage D6/37 X

Primary Examiner—Bruce W. Dunkins
Attorney, Agent, or Firm—Paul L. Hickman

[57] **CLAIM**

The ornamental design for a flutable lounge chair or similar article, as shown.

DESCRIPTION

FIG. 1 is a right side elevational view of a flutable lounge chair or similar article showing my design, the left side being a mirror image thereof;
FIG. 2 is a front elevational view;
FIG. 3 is a rear elevational view;
FIG. 4 is a top plan view;
FIG. 5 is a bottom plan view; and
FIG. 6 is a perspective view thereof.

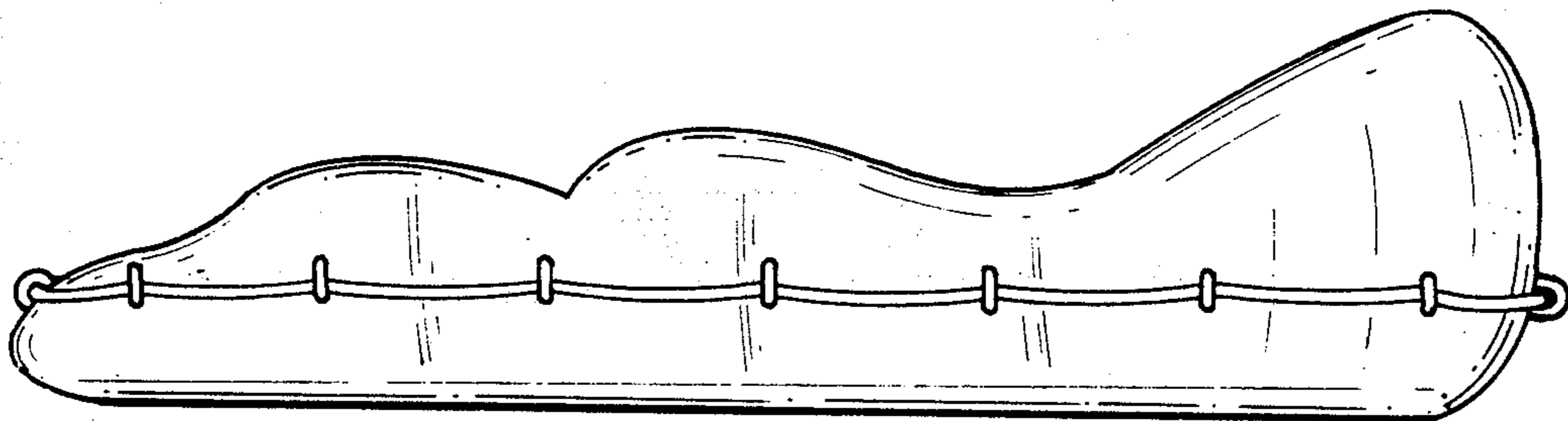

FIG-1-

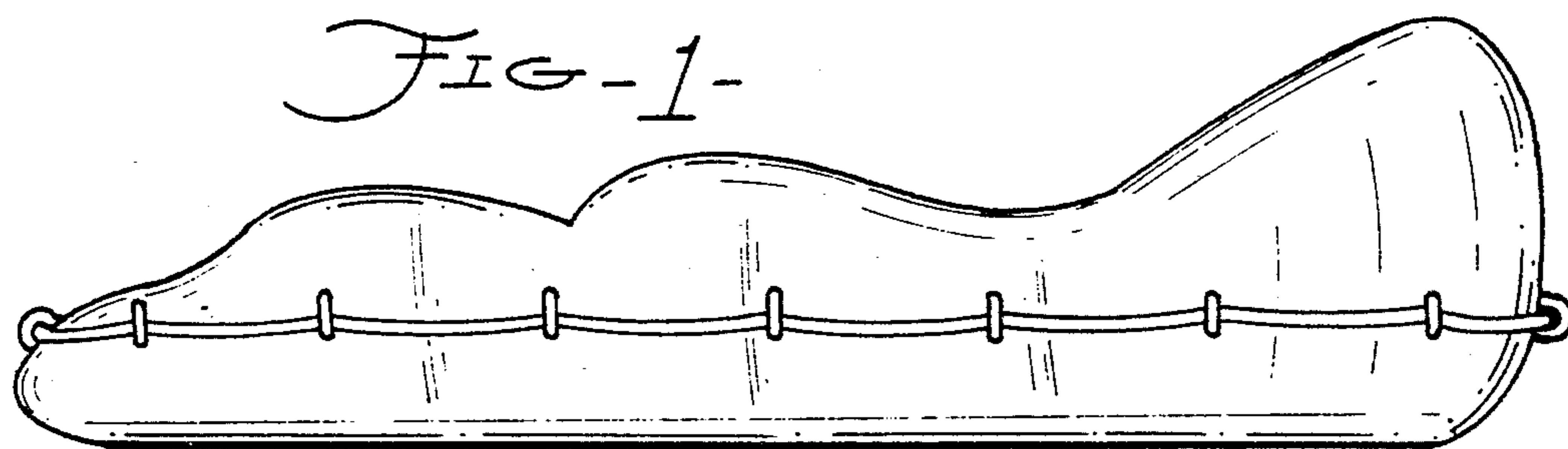

FIG-2-

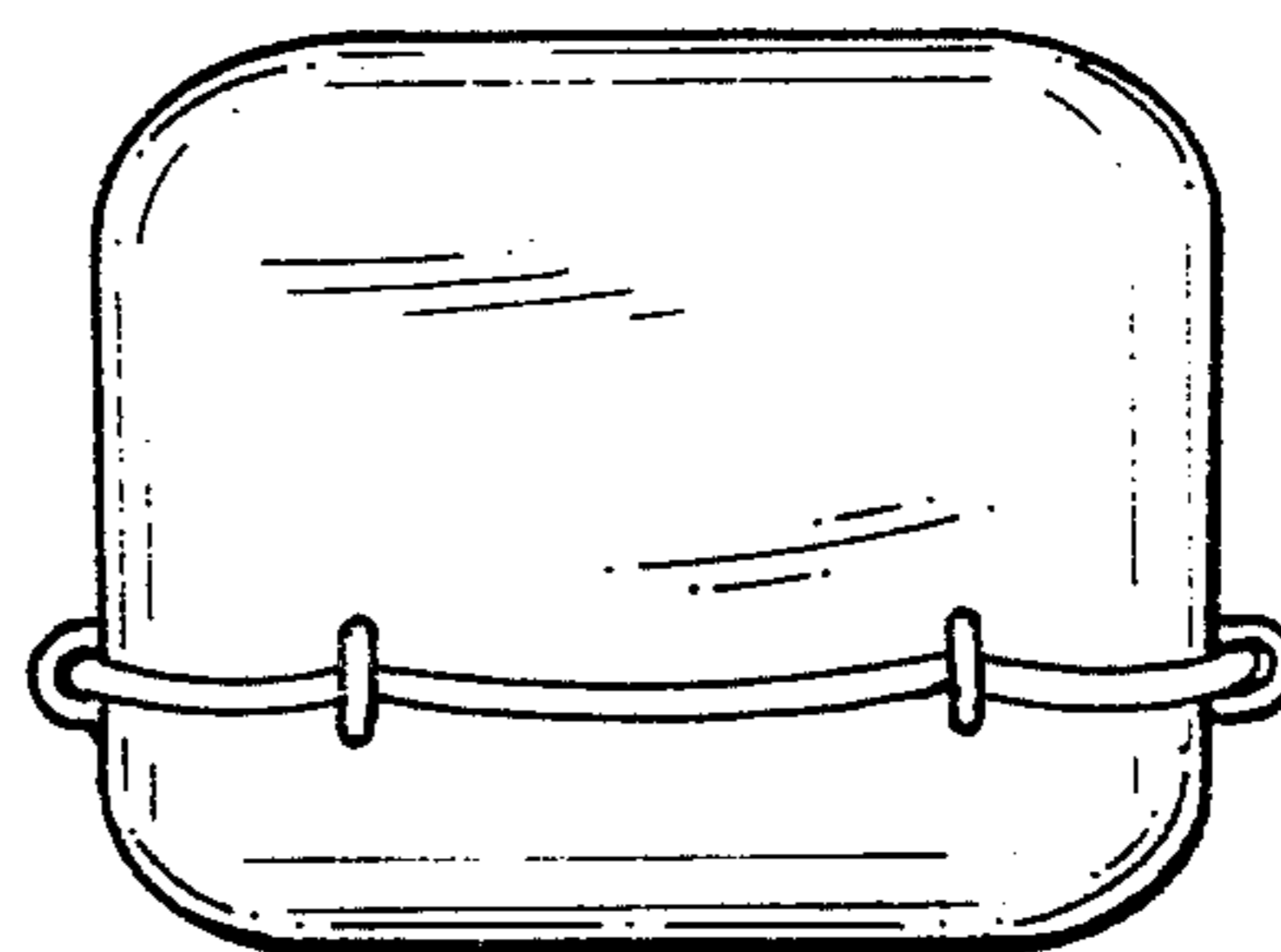
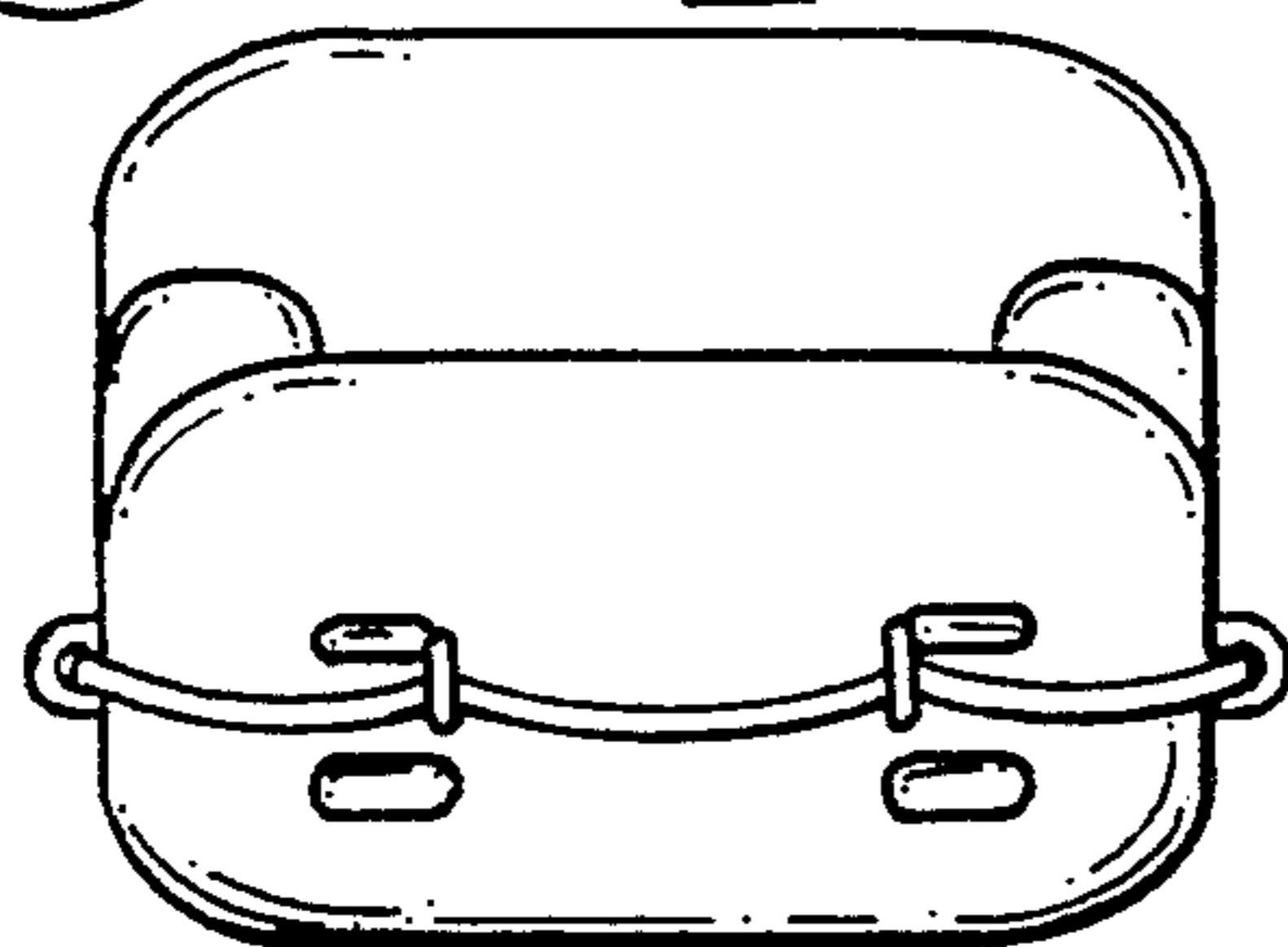

FIG-4-

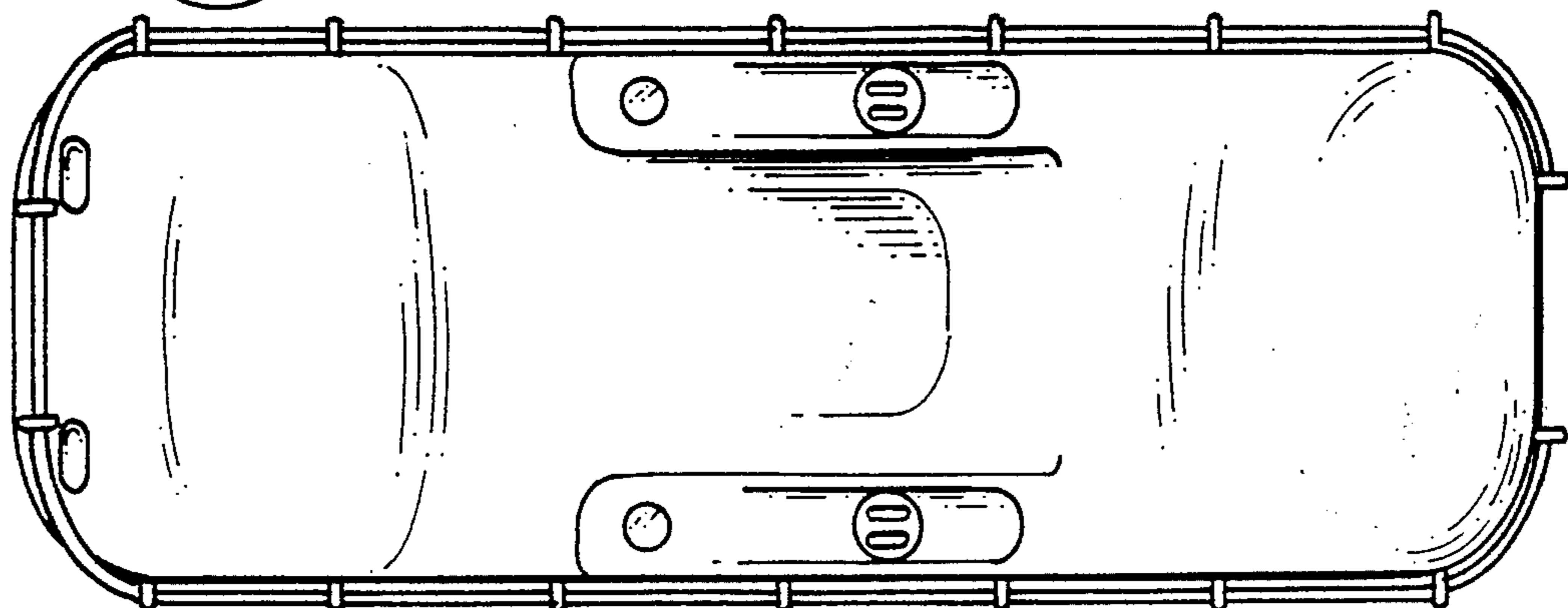

FIG-3-

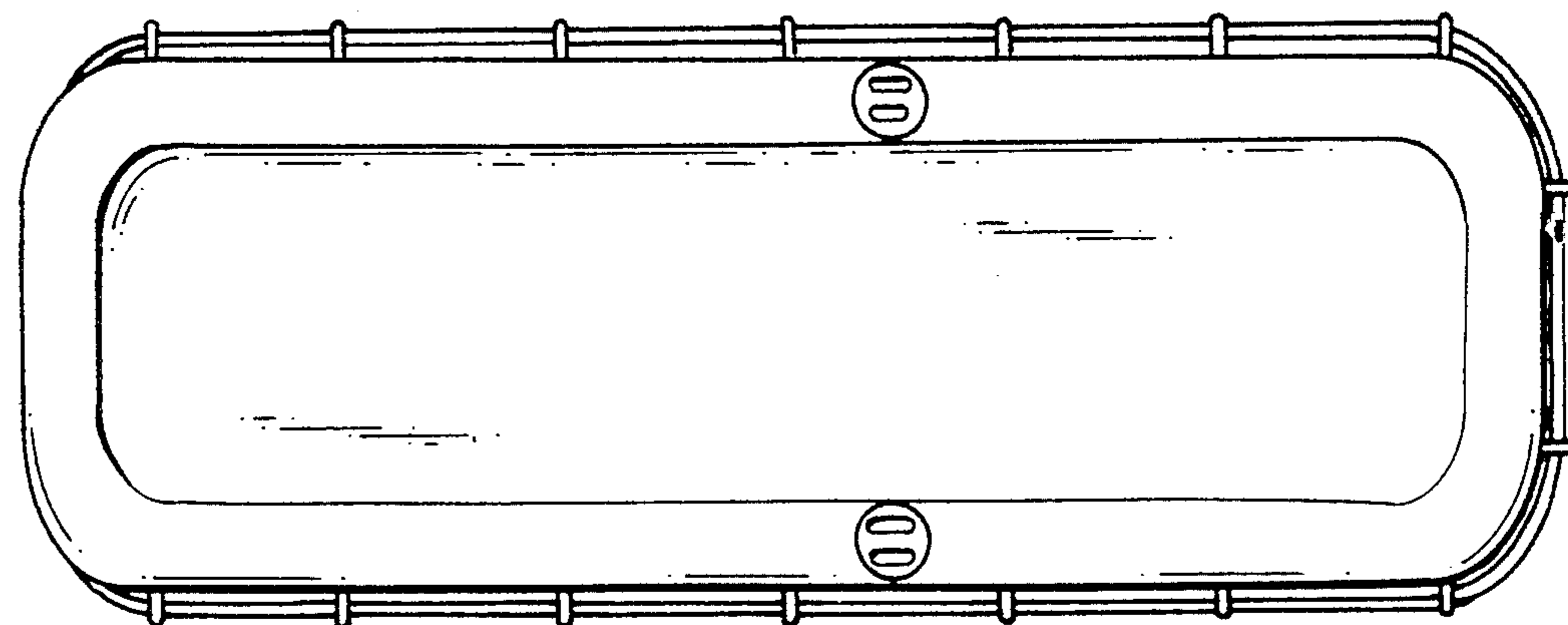

FIG-5-

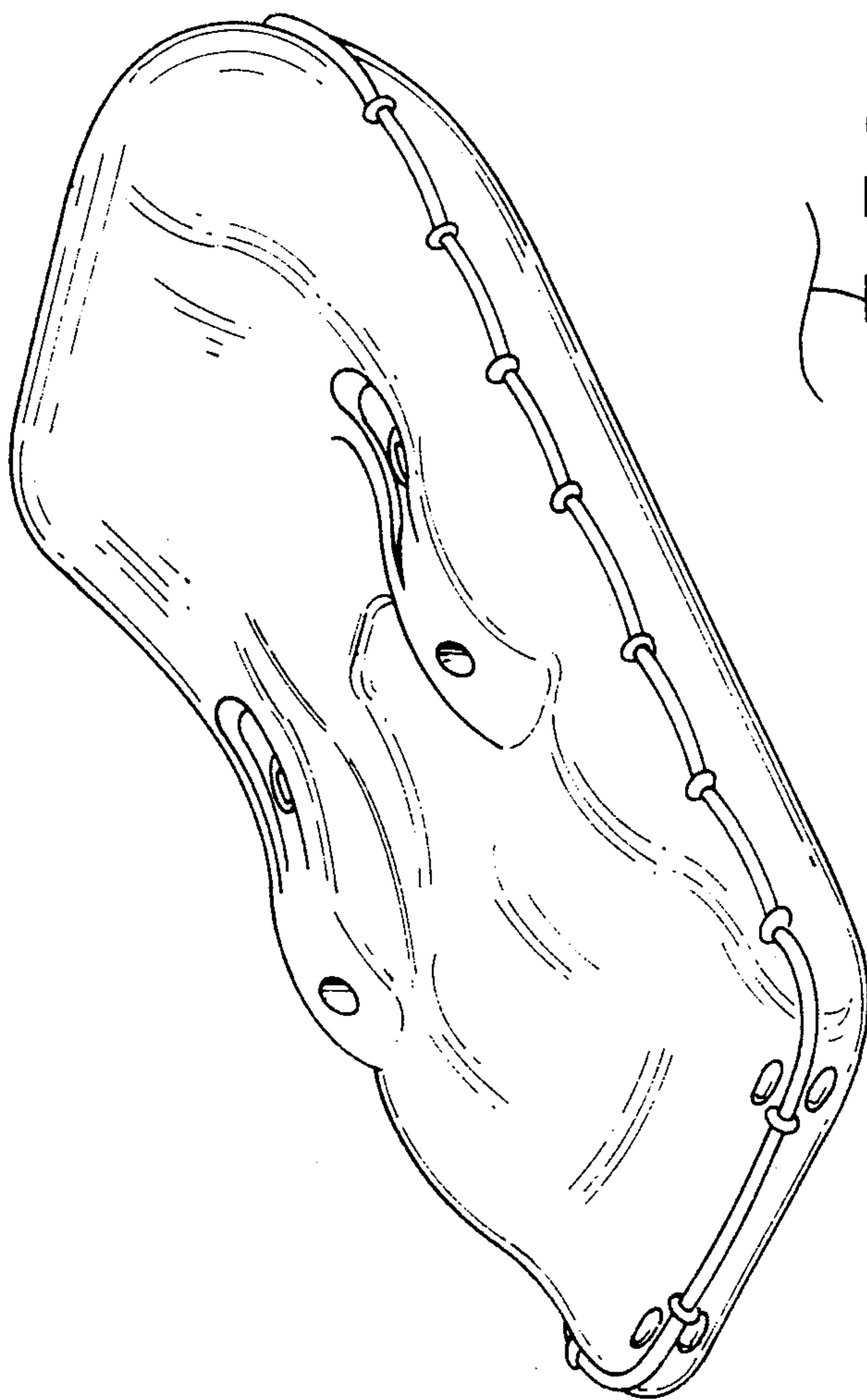

FIG-6