

[54] TIMED SPRAYER UNIT

[76] Inventor: Masanao Yoshizawa, 5046-1, Ohaza Hiraga Saku-shi Nagon-ken, Japan

[**] Term: 14 Years

[21] Appl. No.: 253,963

[22] Filed: Apr. 13, 1981

[52] U.S. Cl. D23/18

[58] Field of Search D23/17, 18; 239/70, 239/215, 218.5, 332

[56] References Cited

U.S. PATENT DOCUMENTS

D. 215,437	9/1969	Halaby, Jr.	D23/17
D. 228,899	10/1973	Price et al.	D23/18 X
D. 236,893	9/1975	Beichlo	D23/18
3,388,834	6/1968	Hart	239/70 X

3,543,122	11/1970	Klebanoff et al.	239/70 X
4,235,373	11/1980	Clark	239/70 X

Primary Examiner—James R. Largen
Attorney, Agent, or Firm—Fred Philpitt

[57] CLAIM

The ornamental design for a timed sprayer unit, as shown and described.

DESCRIPTION

FIG. 1 is a top plan view of a timed sprayer unit showing my new design;
FIG. 2 is a left side elevational view thereof;
FIG. 3 is a bottom plan view thereof;
FIG. 4 is a rear elevational view thereof;
FIG. 5 is a right side elevational view thereof;
FIG. 6 is a front elevational view thereof; and
FIG. 7 is a perspective view taken from the top, front and left side thereof.

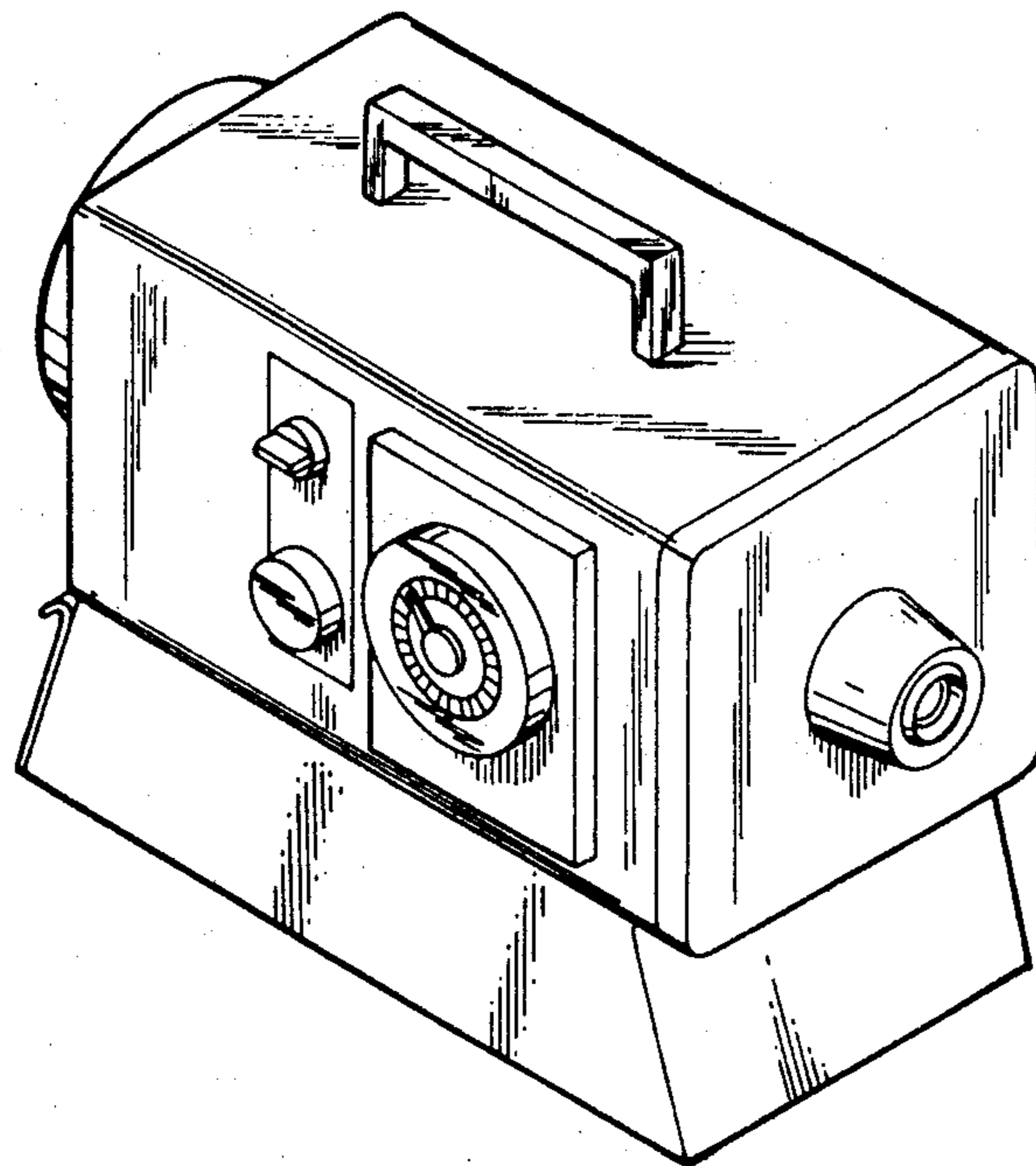

FIG.1

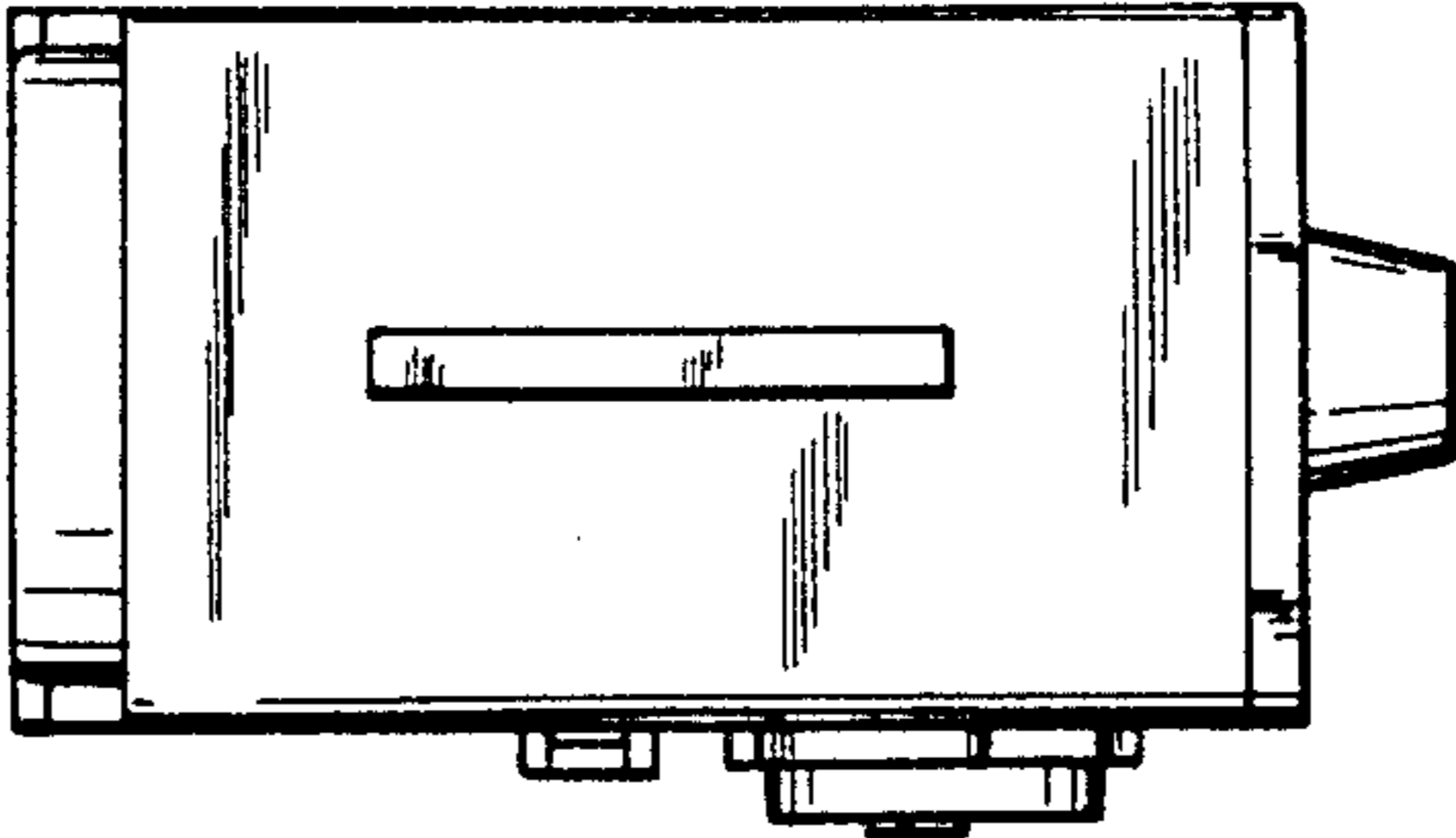

FIG.4

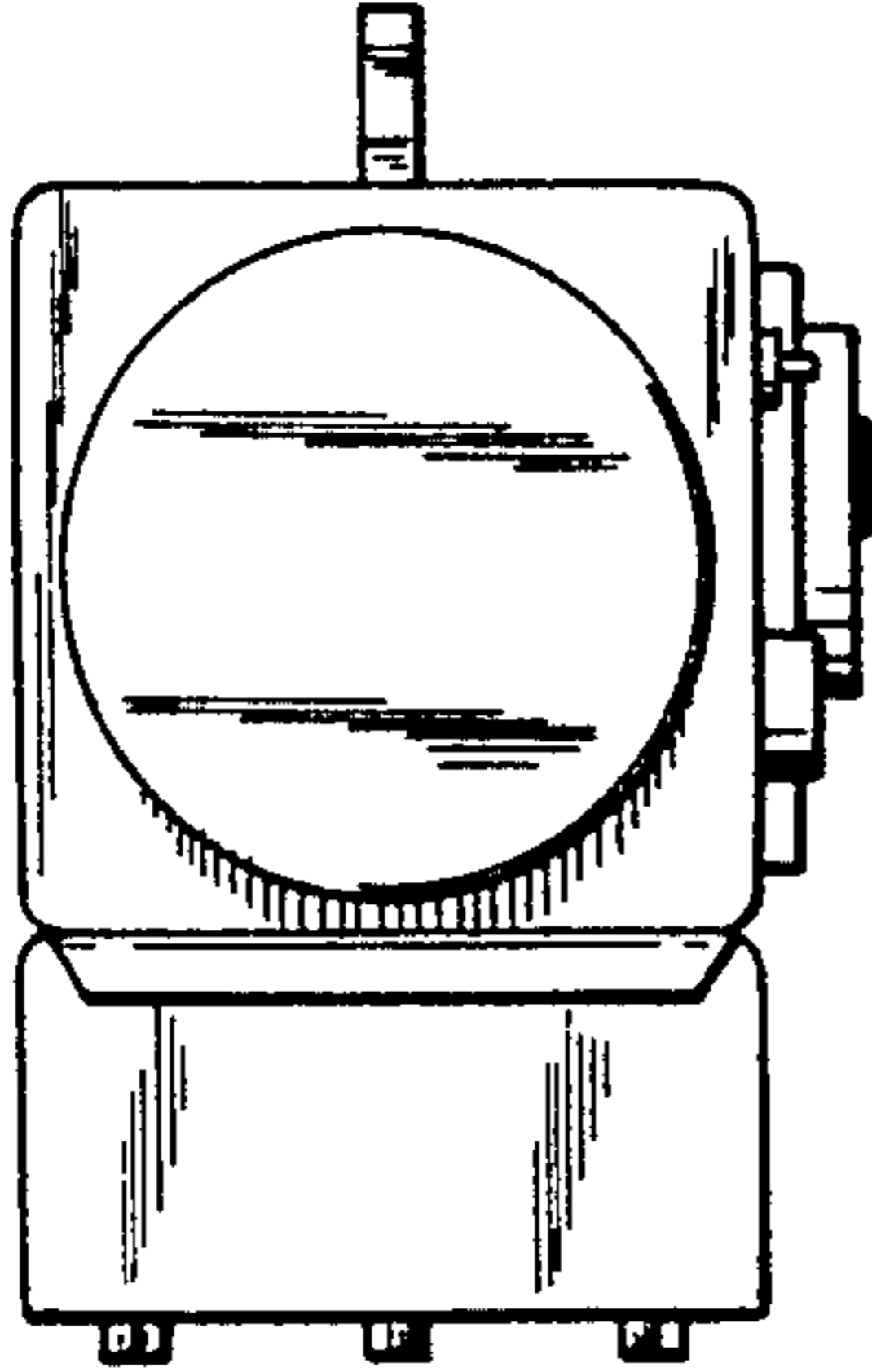

FIG.2

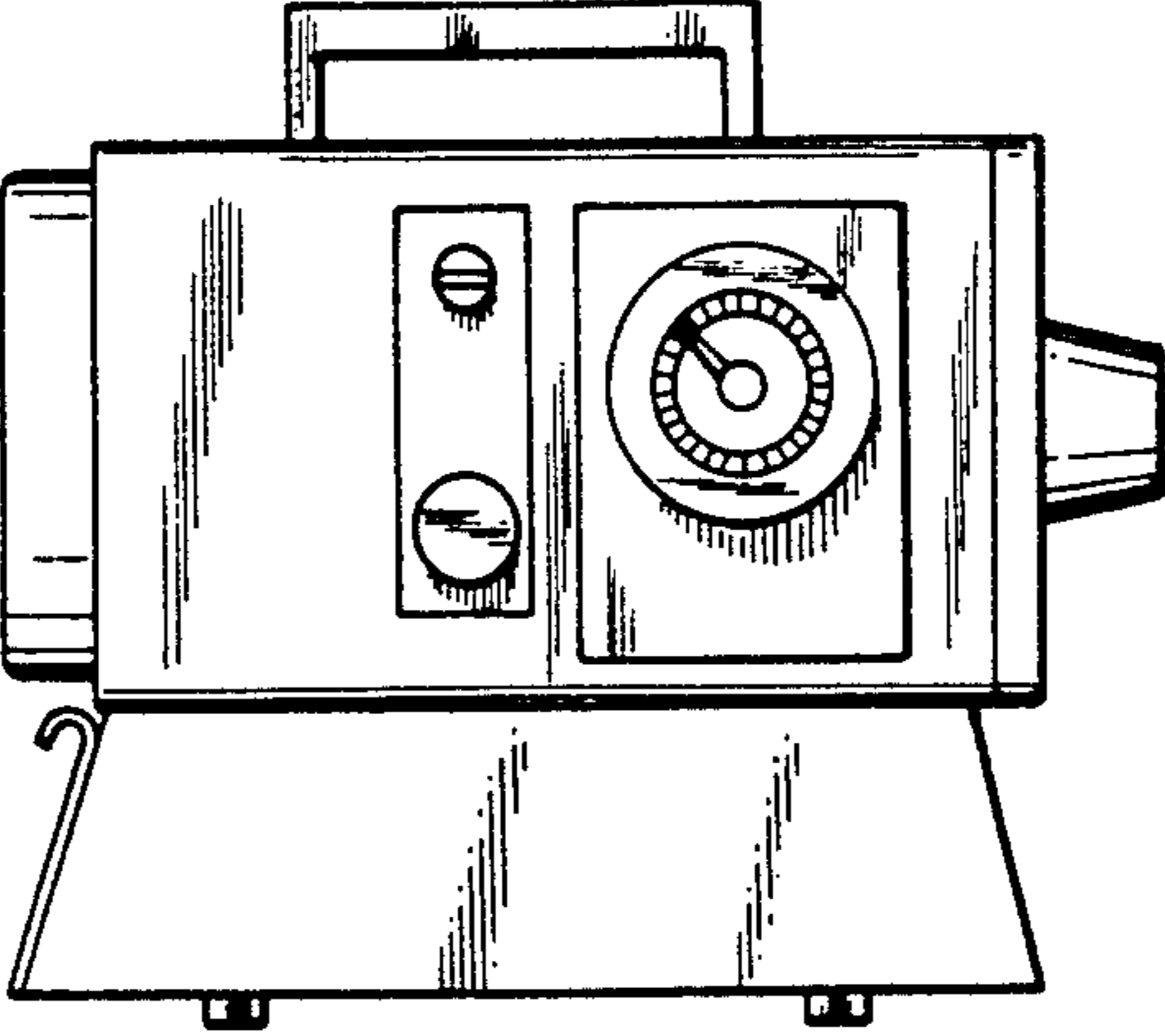

FIG.3

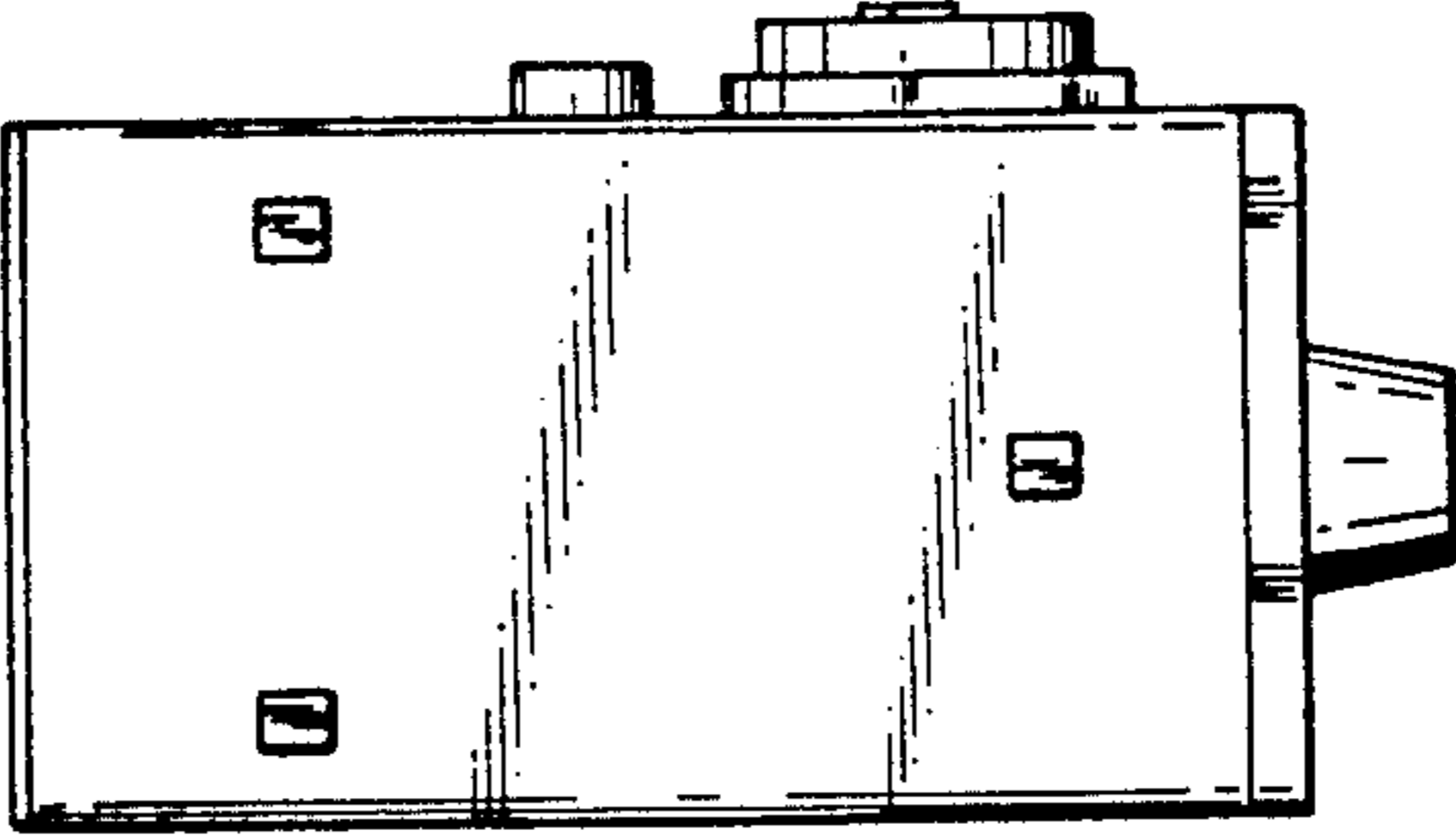

FIG.6

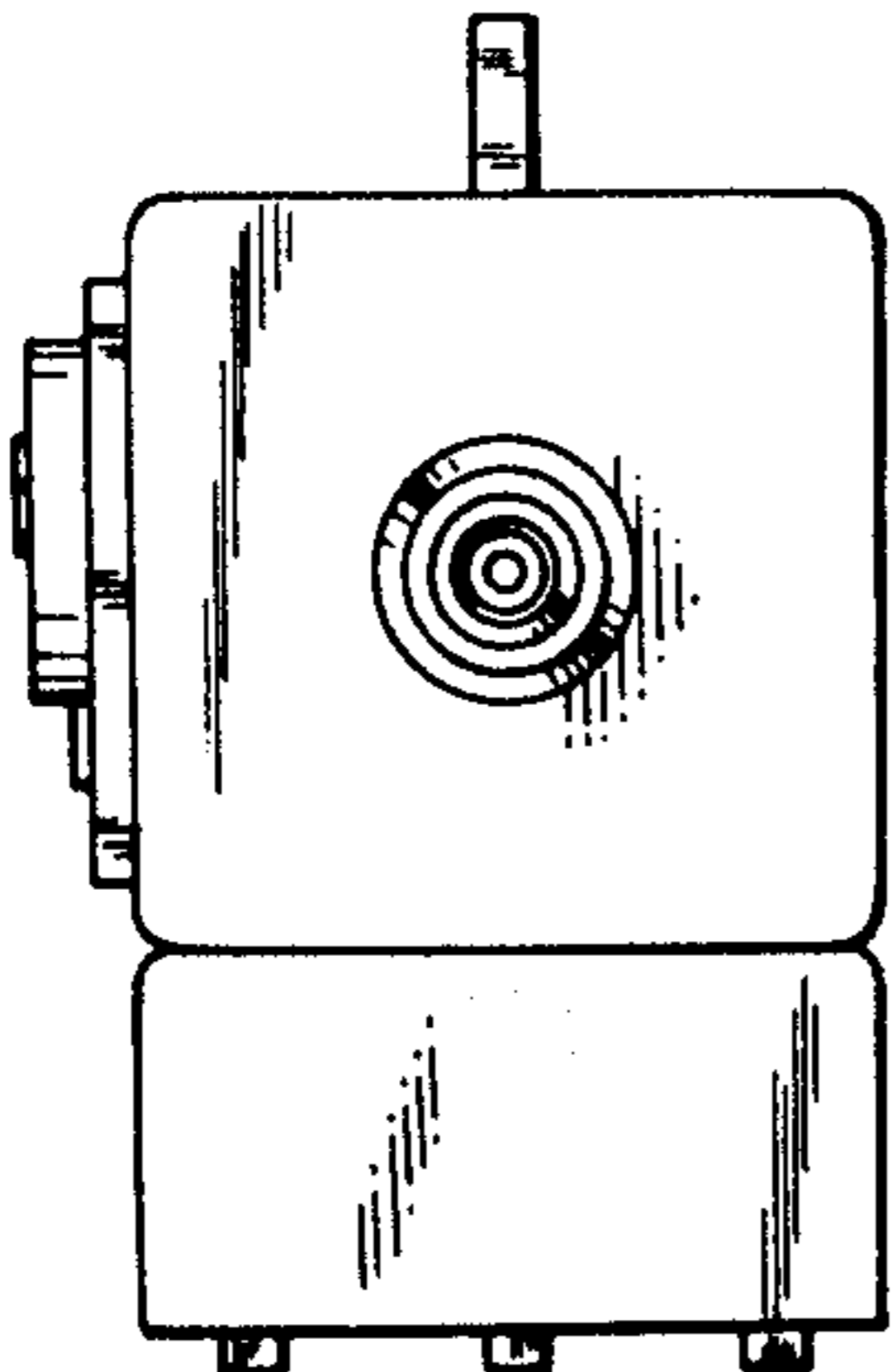

FIG.5

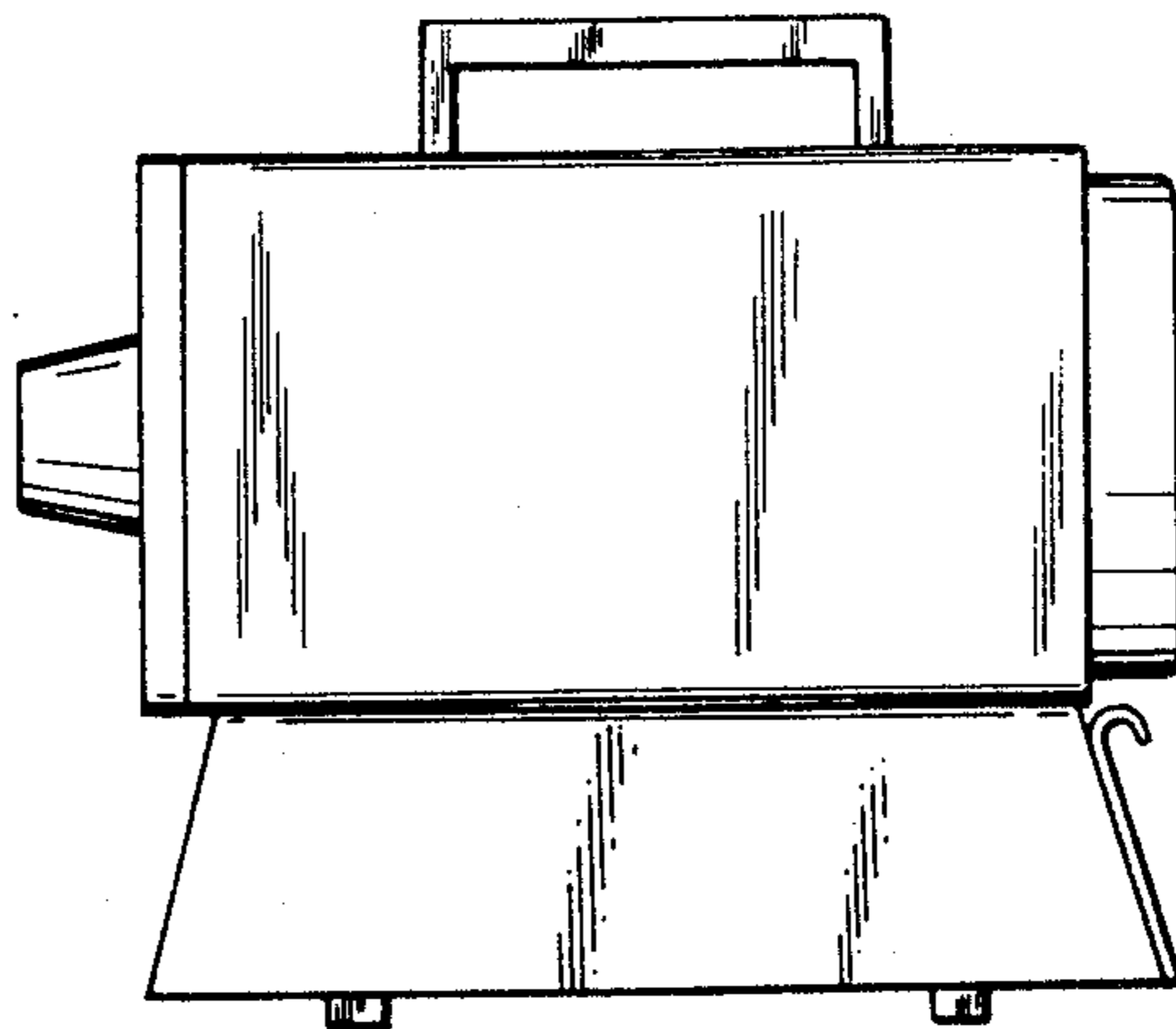

FIG.7

