

- [54] **FOOD STORAGE CONTAINER OR THE LIKE**
- [75] Inventors: **Robert H. C. M. Daenen, Hekelgem, Belgium; Rino Conti, Stoughton, Mass.**
- [73] Assignee: **Dart Industries Inc., Northbrook, Ill.**
- [**] Term: **14 Years**
- [21] Appl. No.: **356,600**
- [22] Filed: **Mar. 9, 1982**
- [52] U.S. Cl. **D7/79; D7/16; D9/418; D9/425**
- [58] Field of Search **D9/377, 425, 403, 404, D9/412, 413, 418, 399, 424, 432; D7/79, 81, 76, 77, 16, 17, 3, 18**

[56] **References Cited**
U.S. PATENT DOCUMENTS

D. 4,757	4/1871	Kirchner	D9/403
D. 112,656	12/1938	Hirschland	D7/79
D. 124,756	8/1940	Wright	D9/414
D. 210,067	2/1968	Abe	D9/403
D. 212,678	11/1968	Swett	D7/76 X
D. 237,861	12/1975	Rossi	D9/404
D. 238,137	12/1975	Swett	D7/79
D. 257,107	9/1980	Daenen et al.	D7/1
D. 258,037	1/1981	Conti	D7/316 X
D. 269,315	6/1983	Conti	D9/404 X
2,590,149	5/1948	Burdett	211/73
3,133,662	5/1964	Seidler	D7/6 X

OTHER PUBLICATIONS

Tupperware Cat., ©1982, p. 4, Item A-35 Classic Sheer Shelf Savers Set, Translucent Canisters with Transparent End Windows, top left panel.
American Handicrafts by Carbone, 2-12-1943, p. 21, center panel, Oval Vases shown "WE 129".

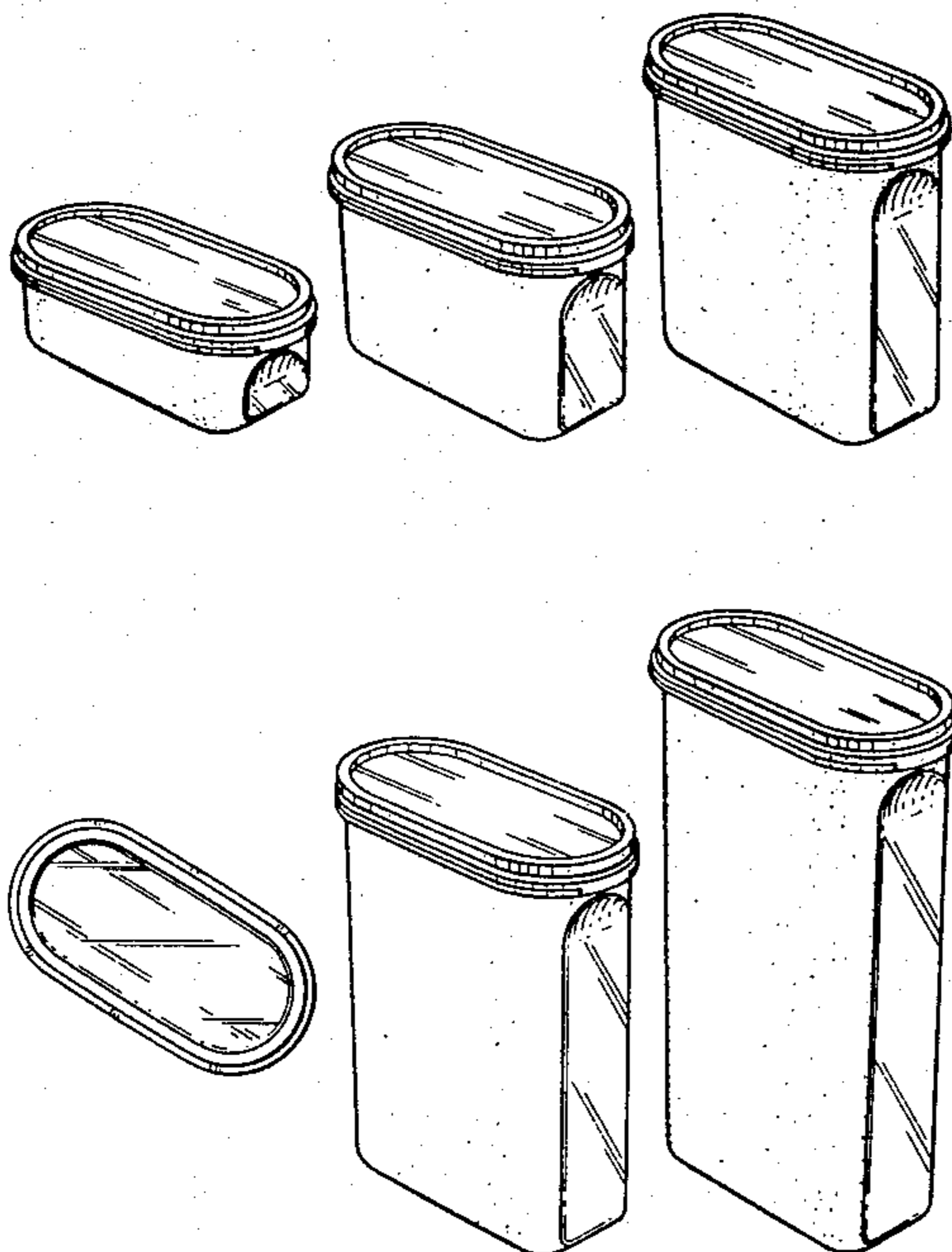

Buchsteiner brochure dated Jul., 1979; products Art. Nr. 3320 and 3322, lower right.
 Sarvis brochure (date unknown), Oblong Covered Storage Canisters with Opaque Covers and Transparent Containers, 2 pages included, no page Nos. given.
 Copco catalog (1982) pp. 6 and 7, Food Savers, Various Sizes of Canisters with Opaque Covers and Transparent Containers, Rectangular Shapes.

Primary Examiner—Winifred E. Herrmann
Attorney, Agent, or Firm—John A. Doninger

[57] **CLAIM**

The ornamental design for a covered food storage container or the like, substantially as shown and described.

DESCRIPTION

FIG. 1 is a top perspective view of a covered food storage container or the like showing our new design; FIGS. 2-5 are top perspective views of modifications of the covered food storage container of FIG. 1; FIG. 6 is a top plan view of FIG. 1, it being understood that the size and proportions of the top plan of FIGS. 2-5 is identical hereto; FIG. 7 is a side elevational view of FIG. 1, the side opposite being identical thereto; FIGS. 8-11 are side elevational views of FIGS. 2-5 respectively, the sides opposite being identical thereto; FIG. 12 is a bottom plan view of FIG. 1, it being understood that the size and proportions of the bottom plan of FIGS. 2-5 is identical hereto; FIG. 13 is a left or right end elevational view of FIG. 1; and FIGS. 14-17 are left or right end elevational views of FIGS. 2-5 respectively.
 The stippled shading on the design represents a frosted (opaque or translucent) material and the end walls thereof are shaded to represent a semi-transparent material.

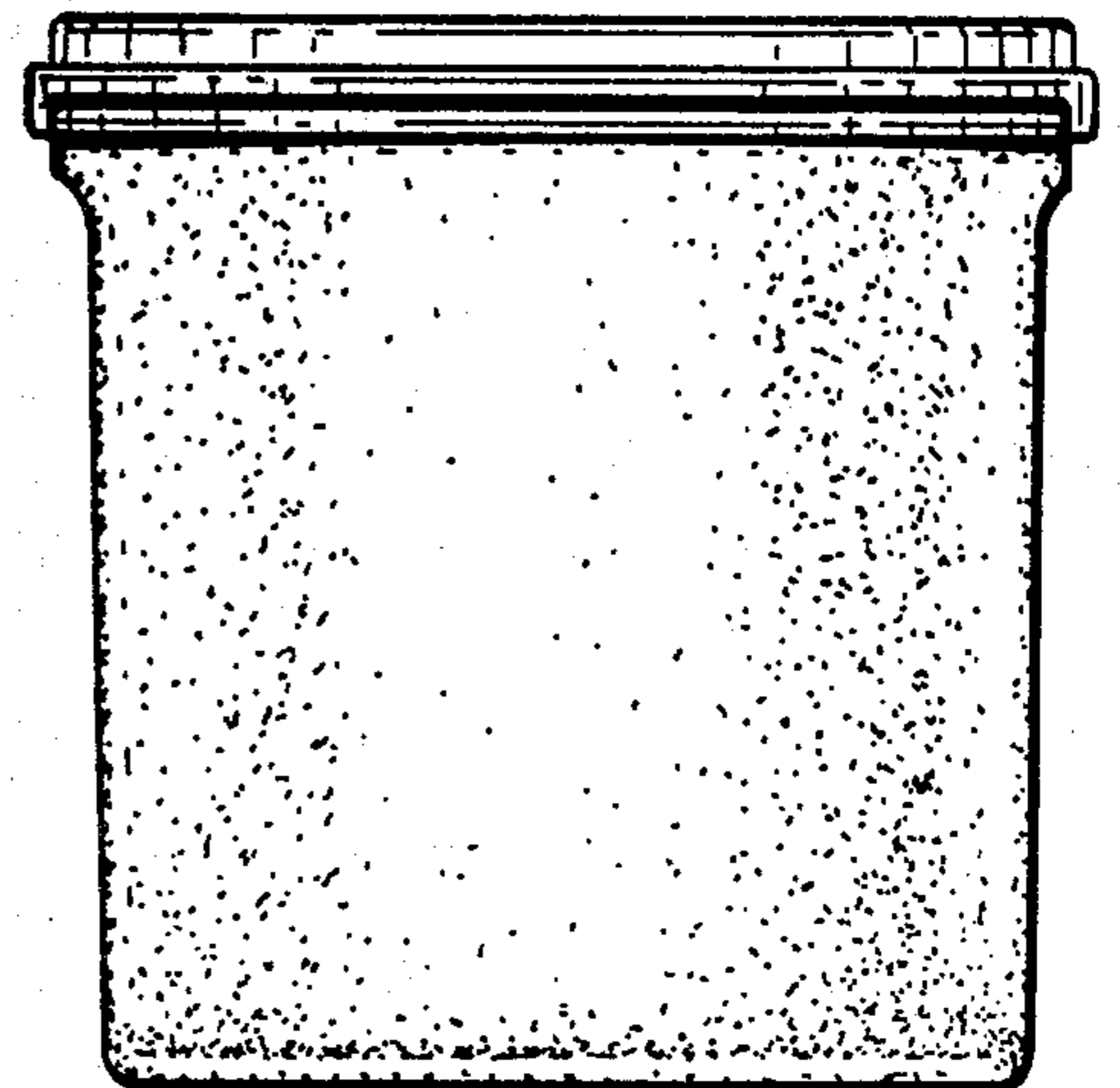

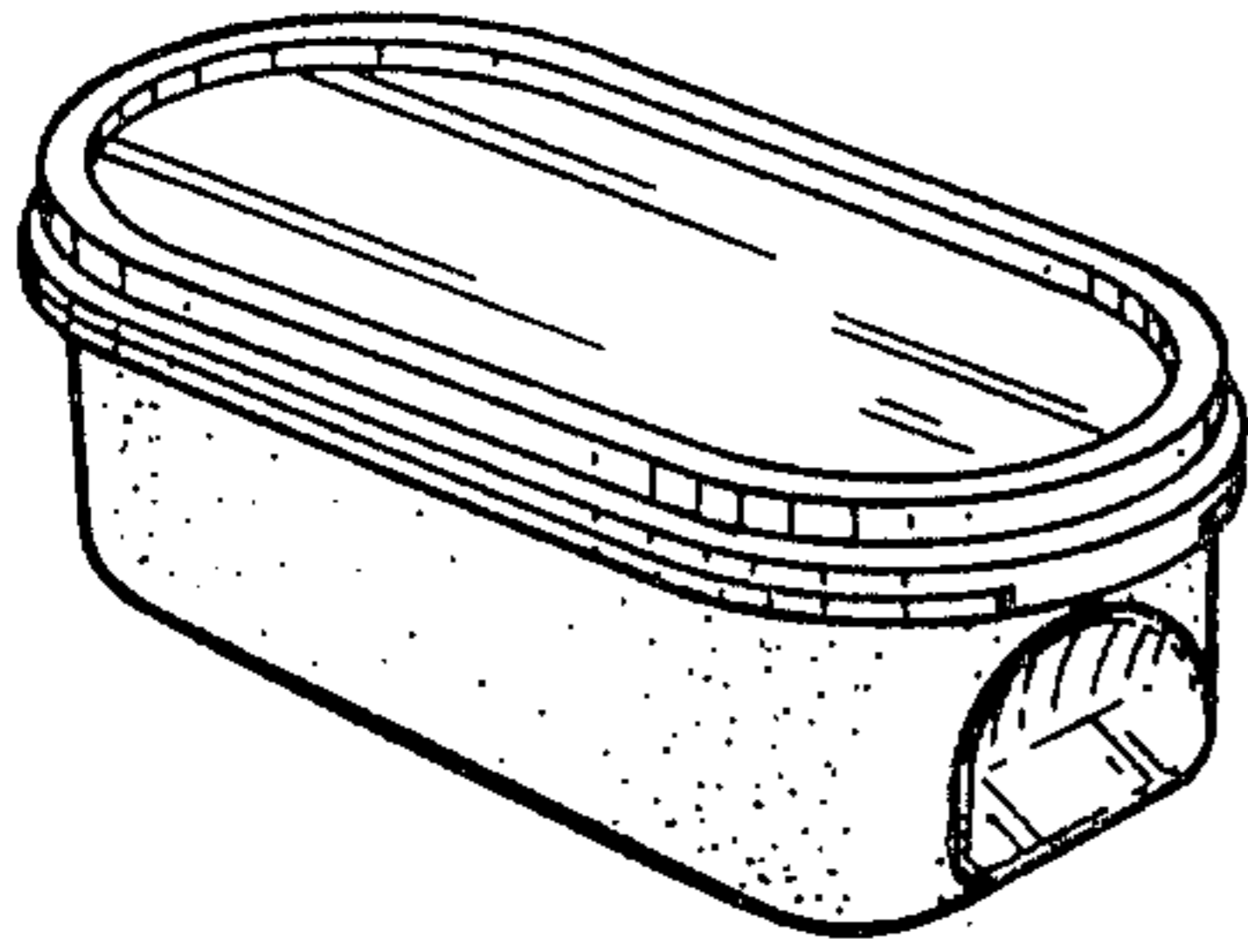

FIG. 2

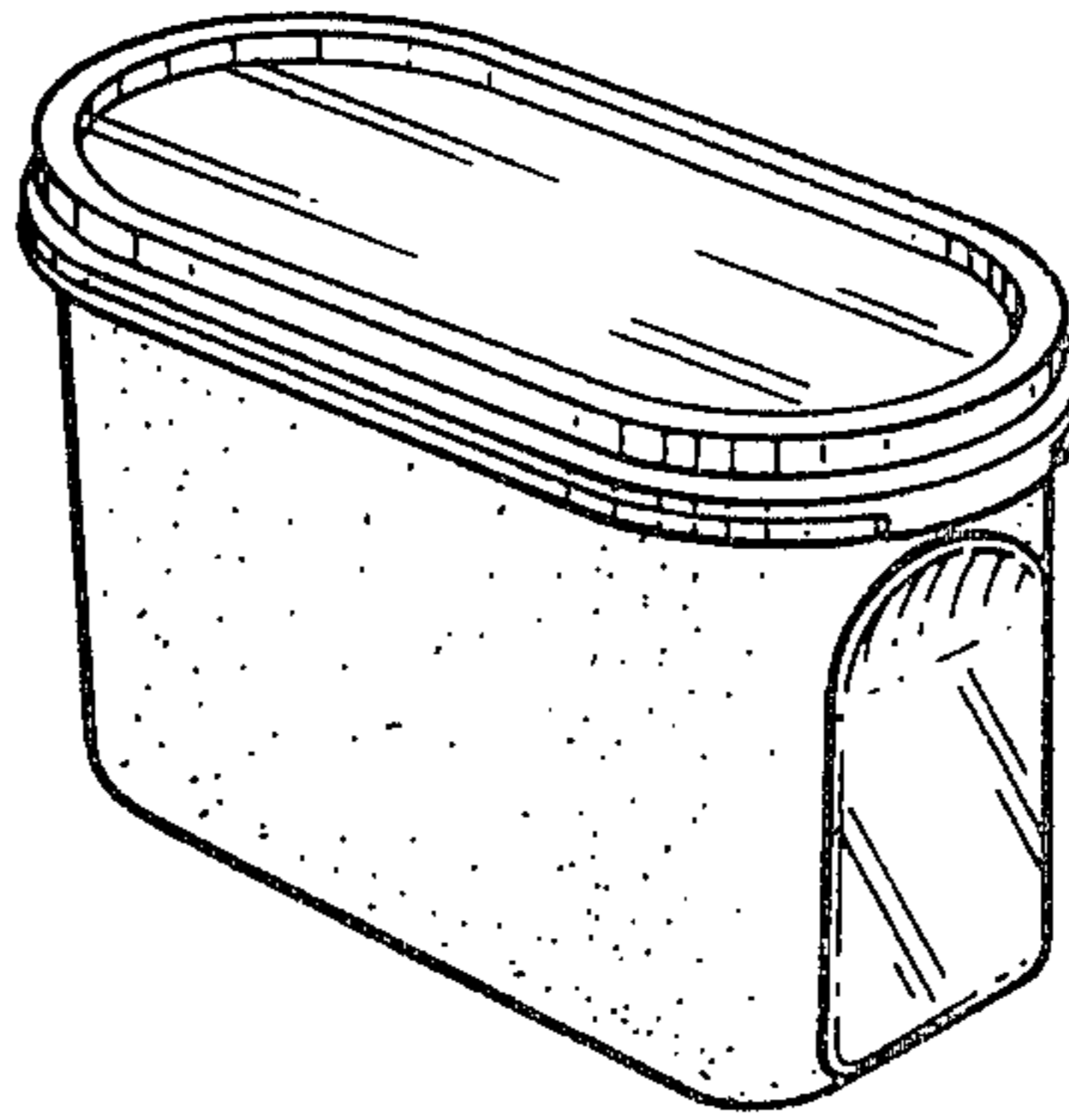

FIG. 3

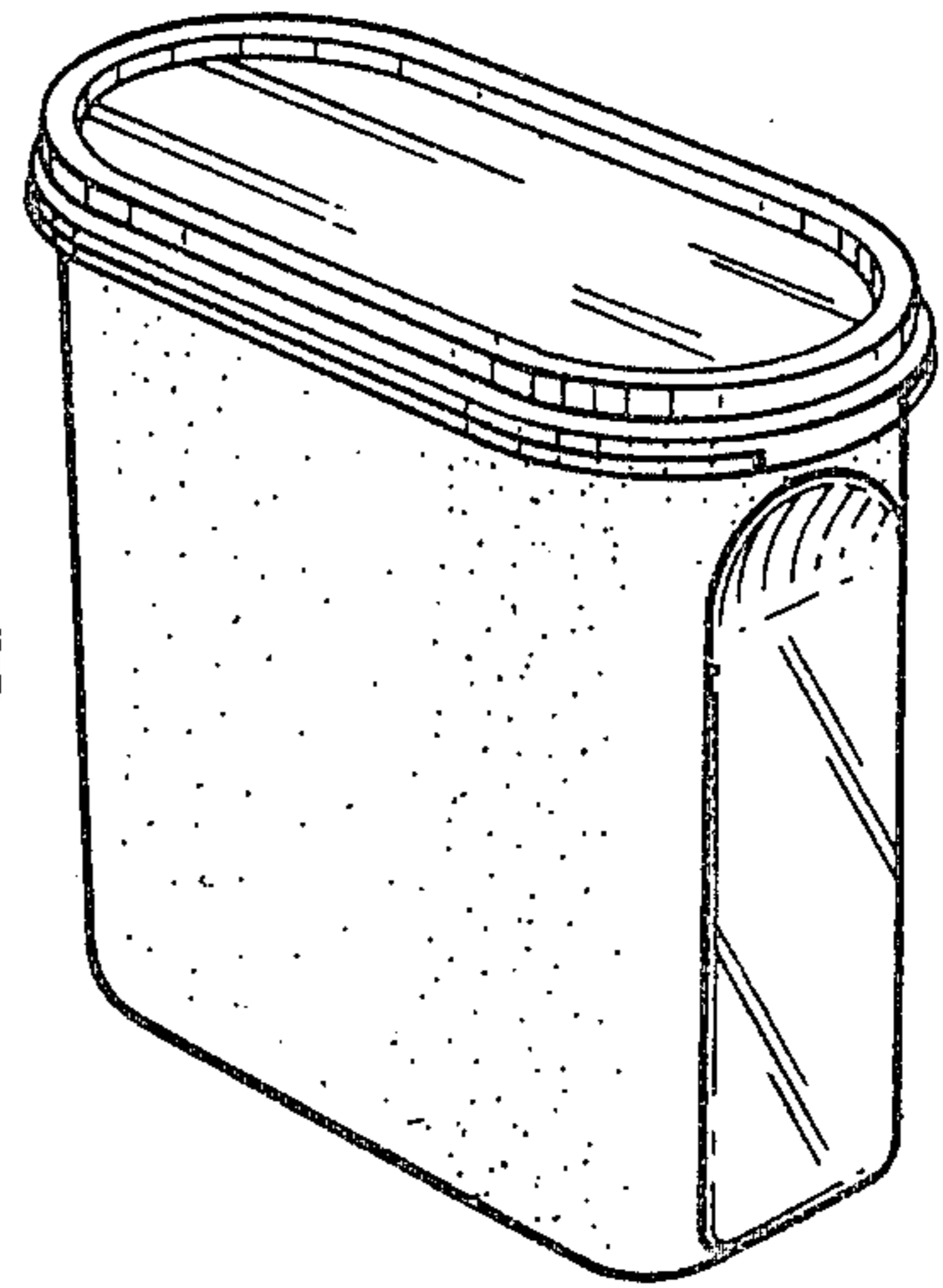

FIG. 1

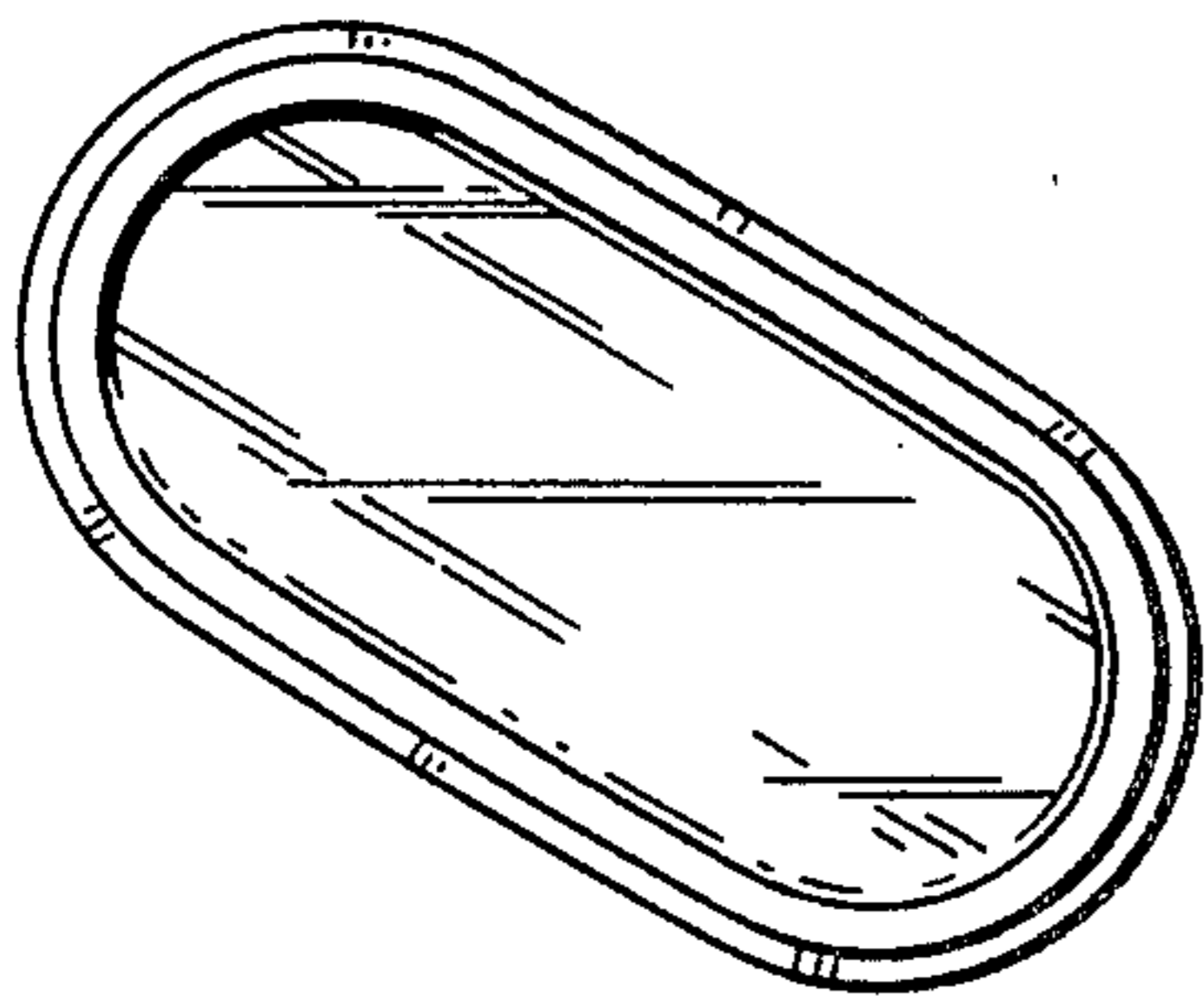

FIG. 6

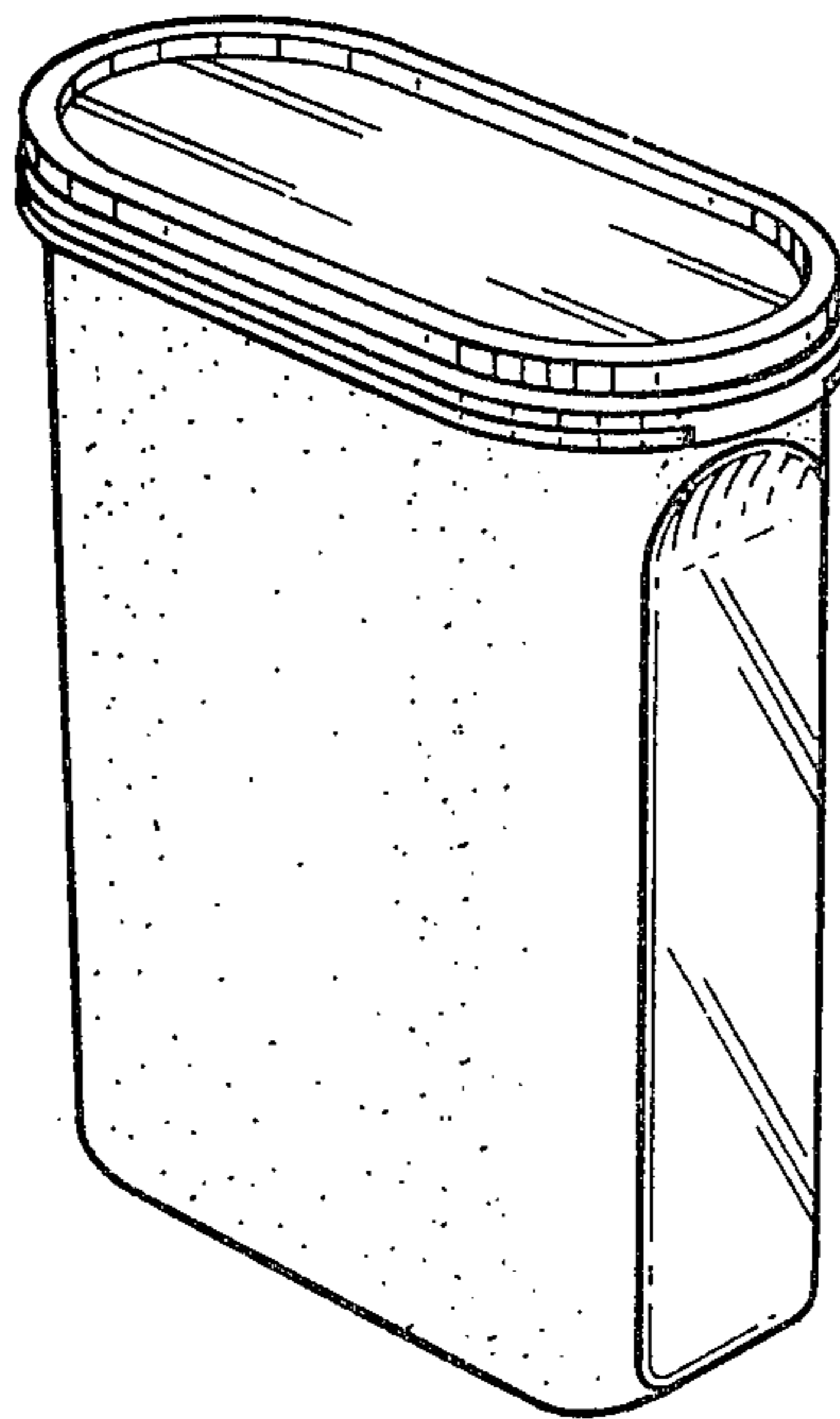

FIG. 4

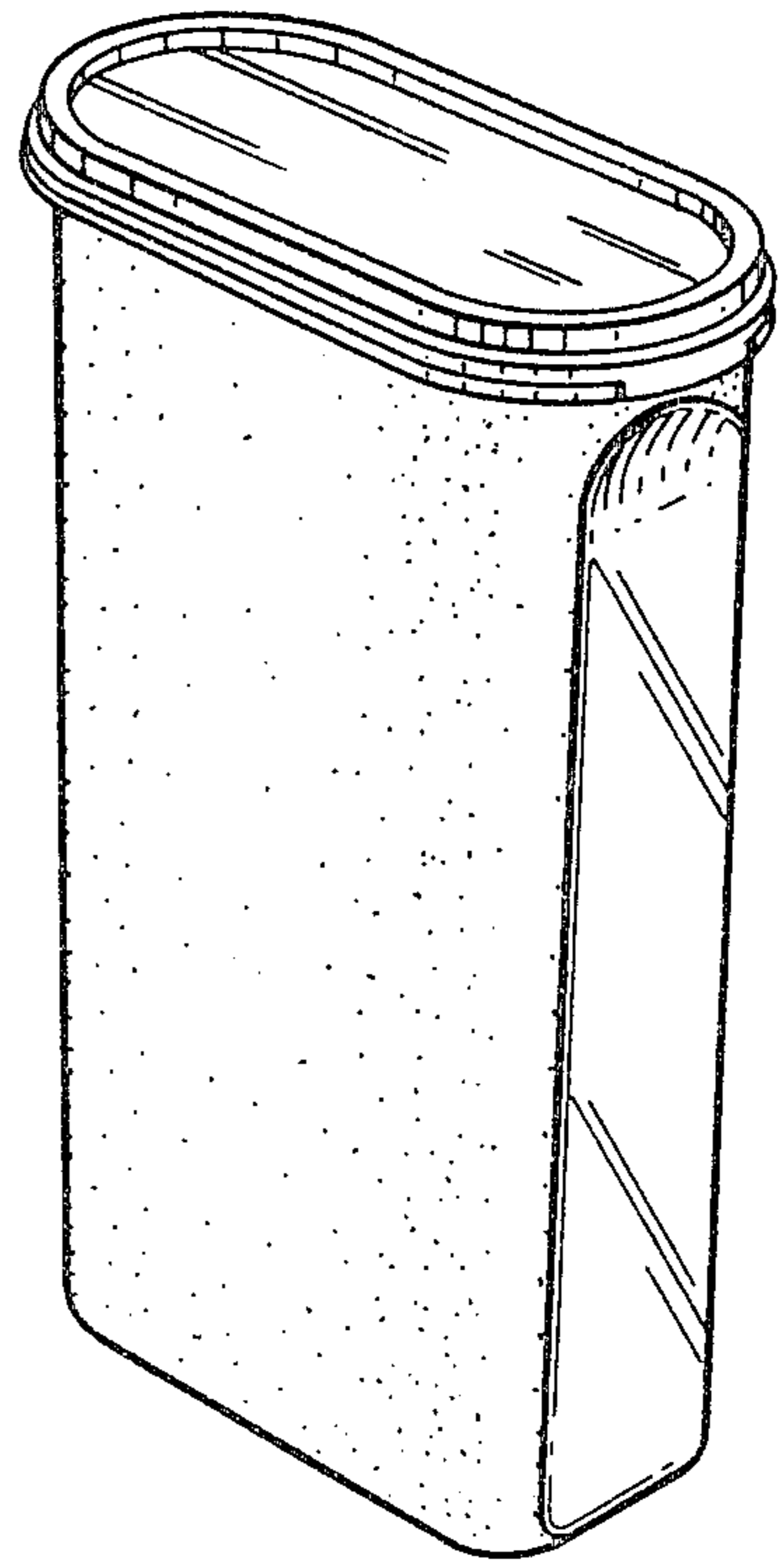

FIG. 5

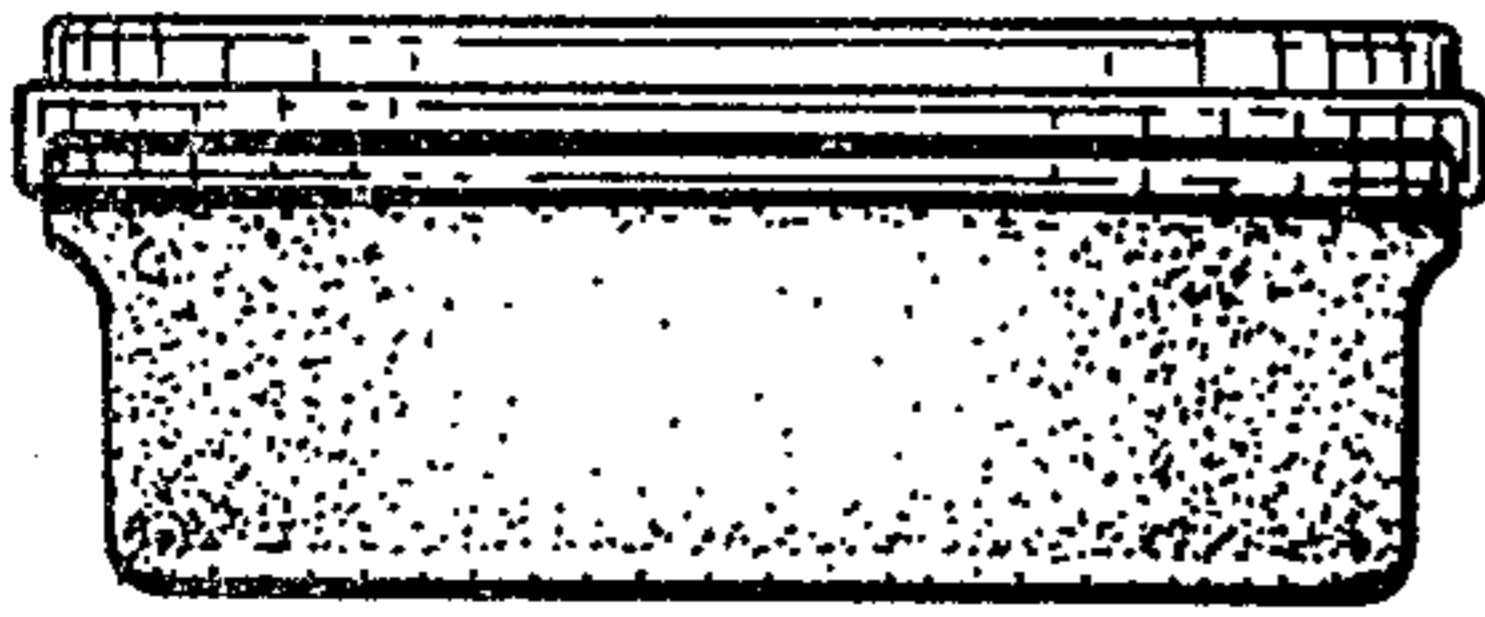

FIG. 8

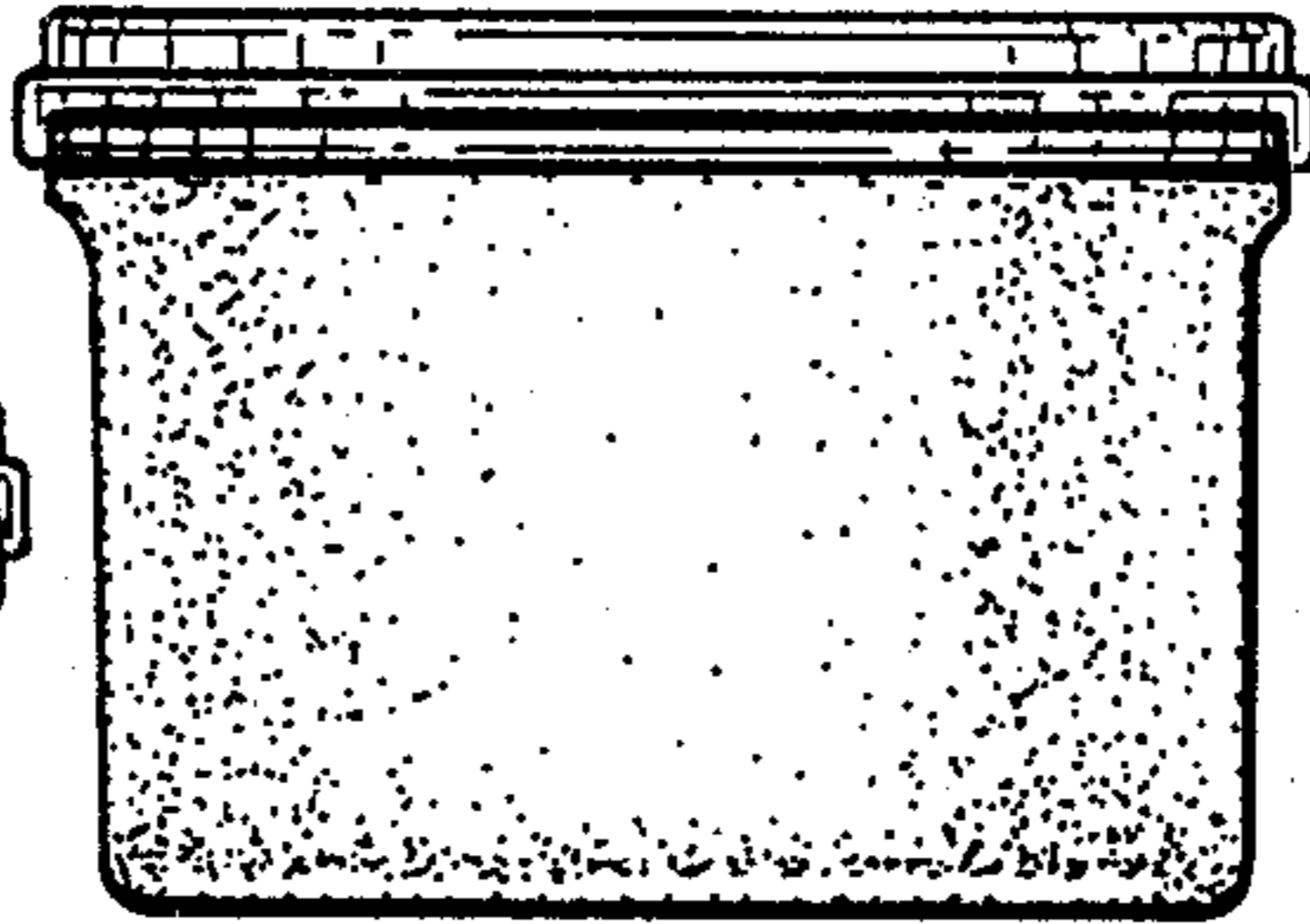

FIG. 9

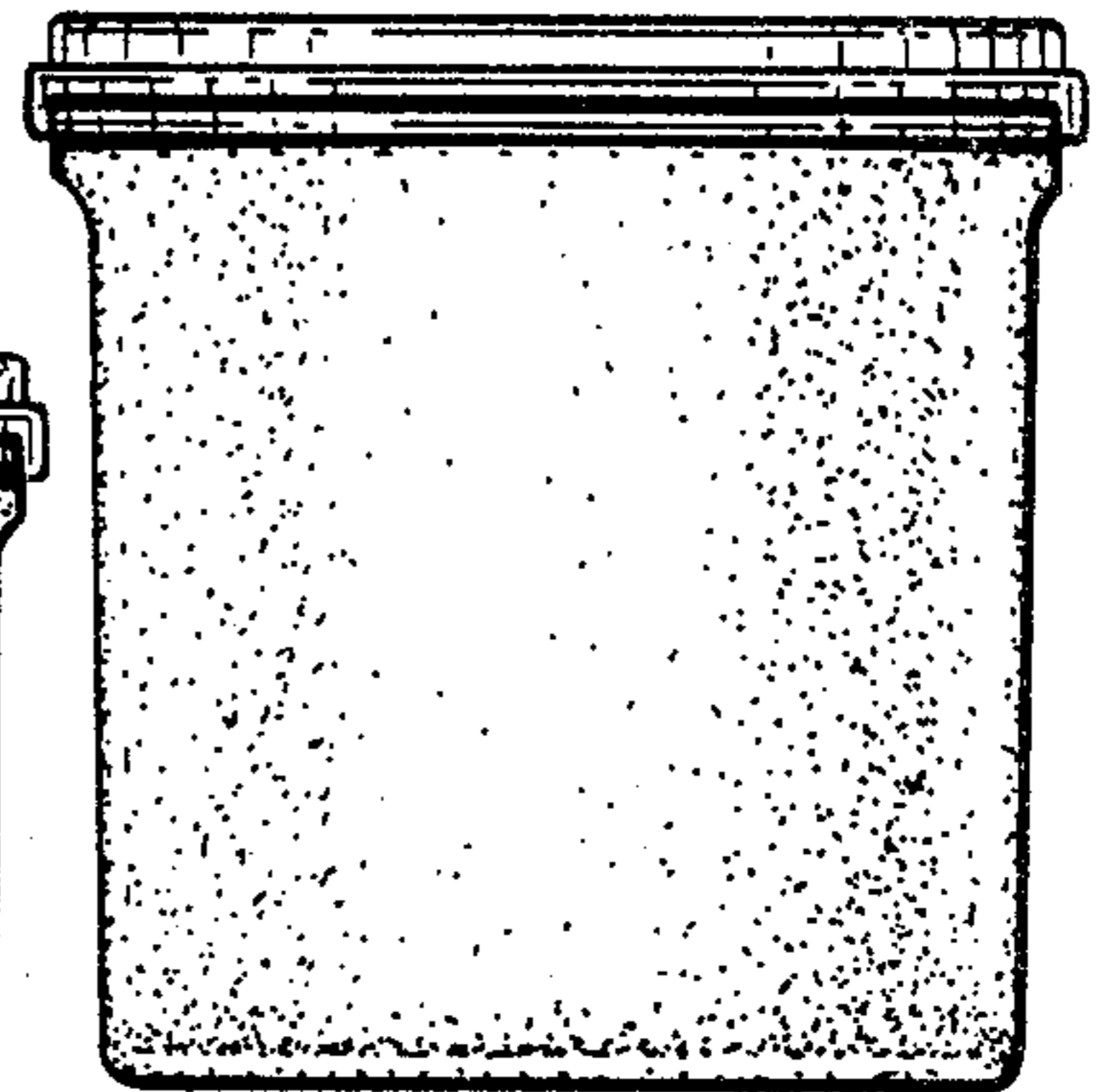

FIG. 7

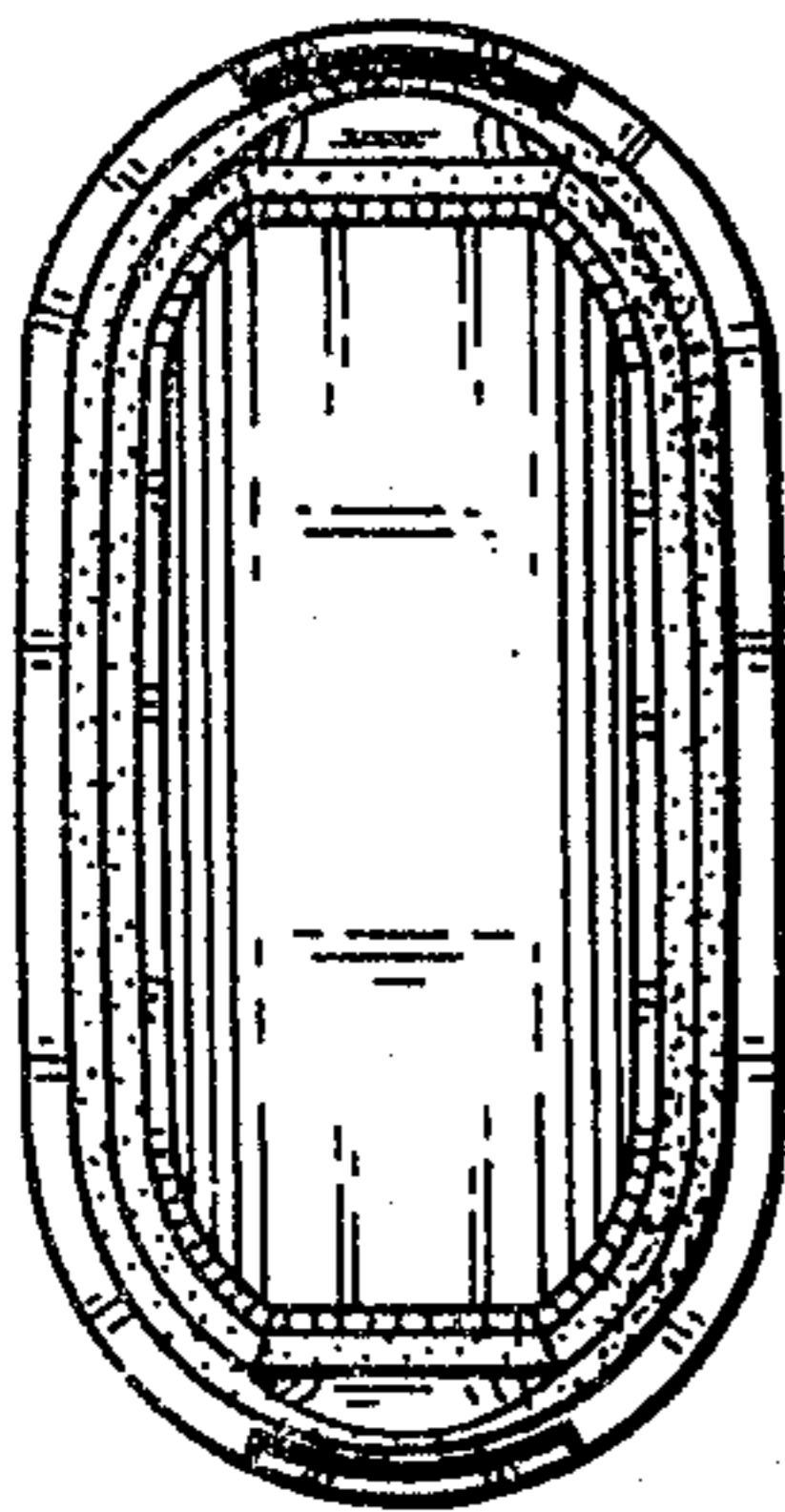

FIG. 12

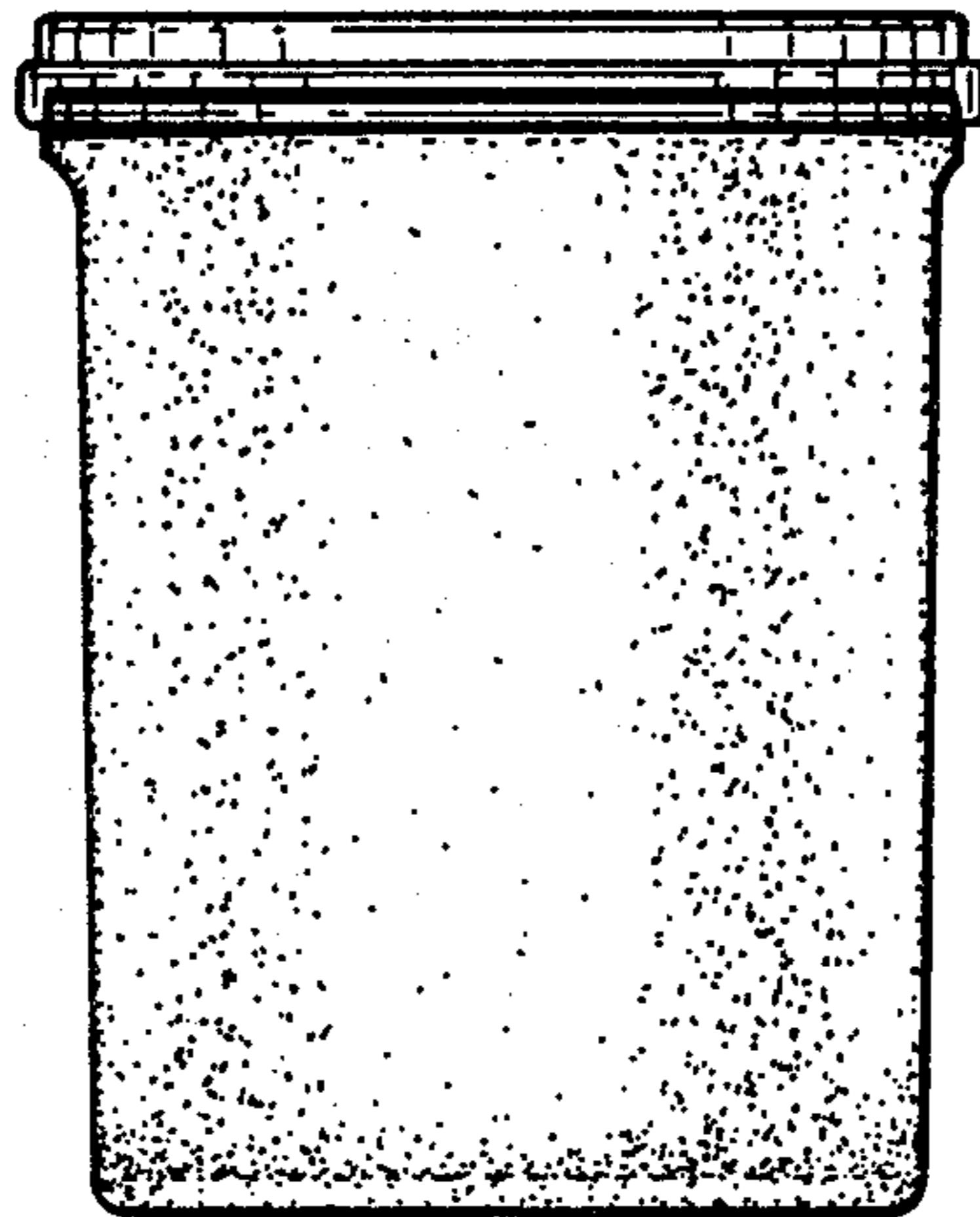

FIG. 10

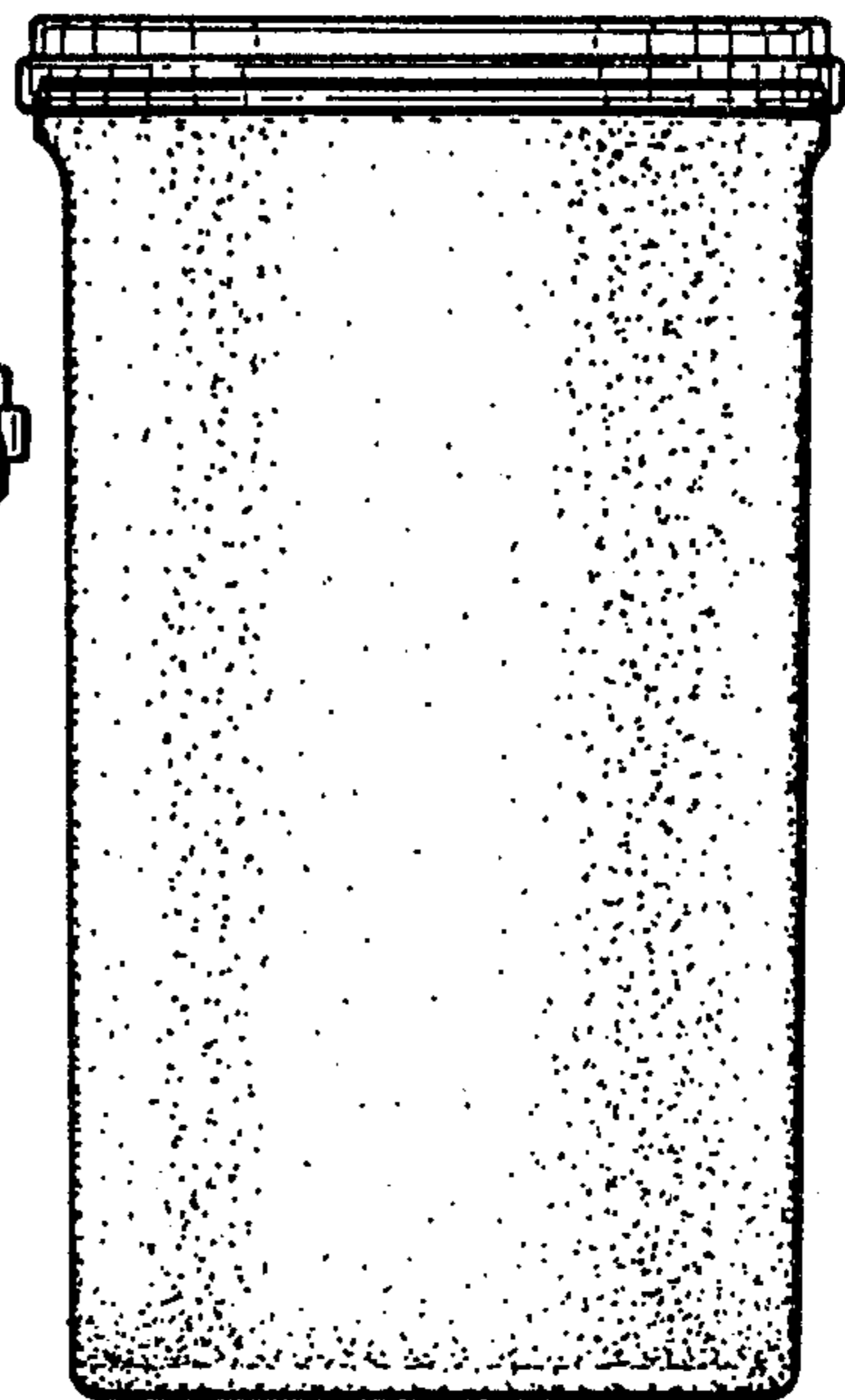

FIG. 11

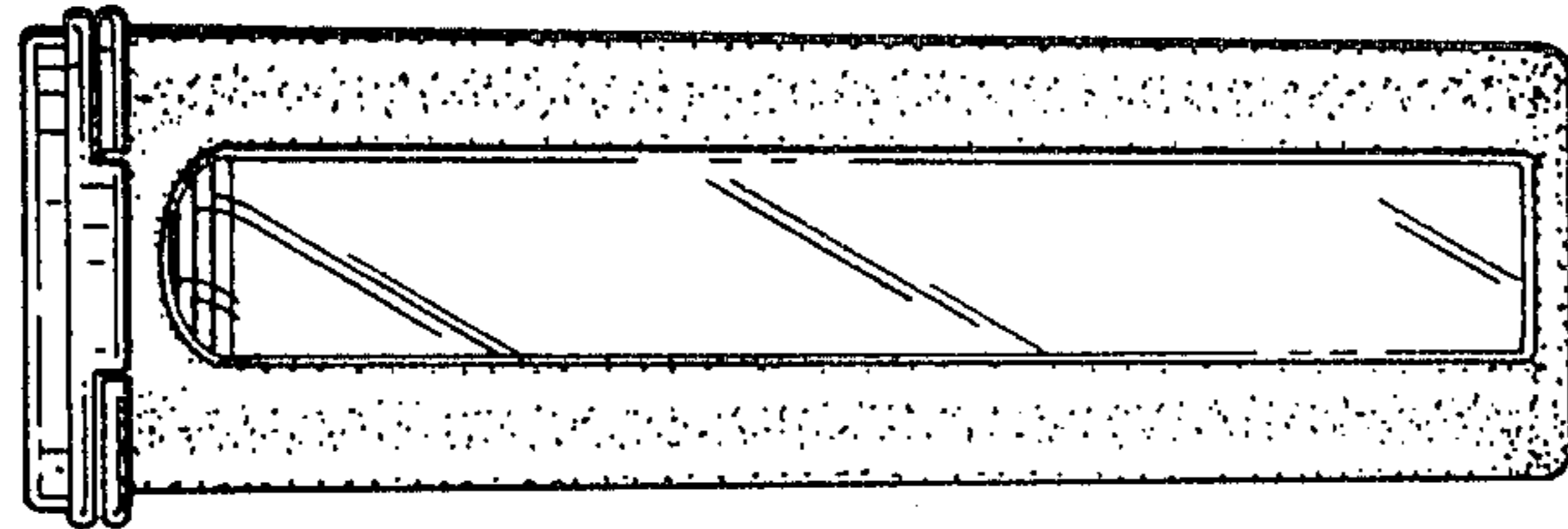

FIG. 17

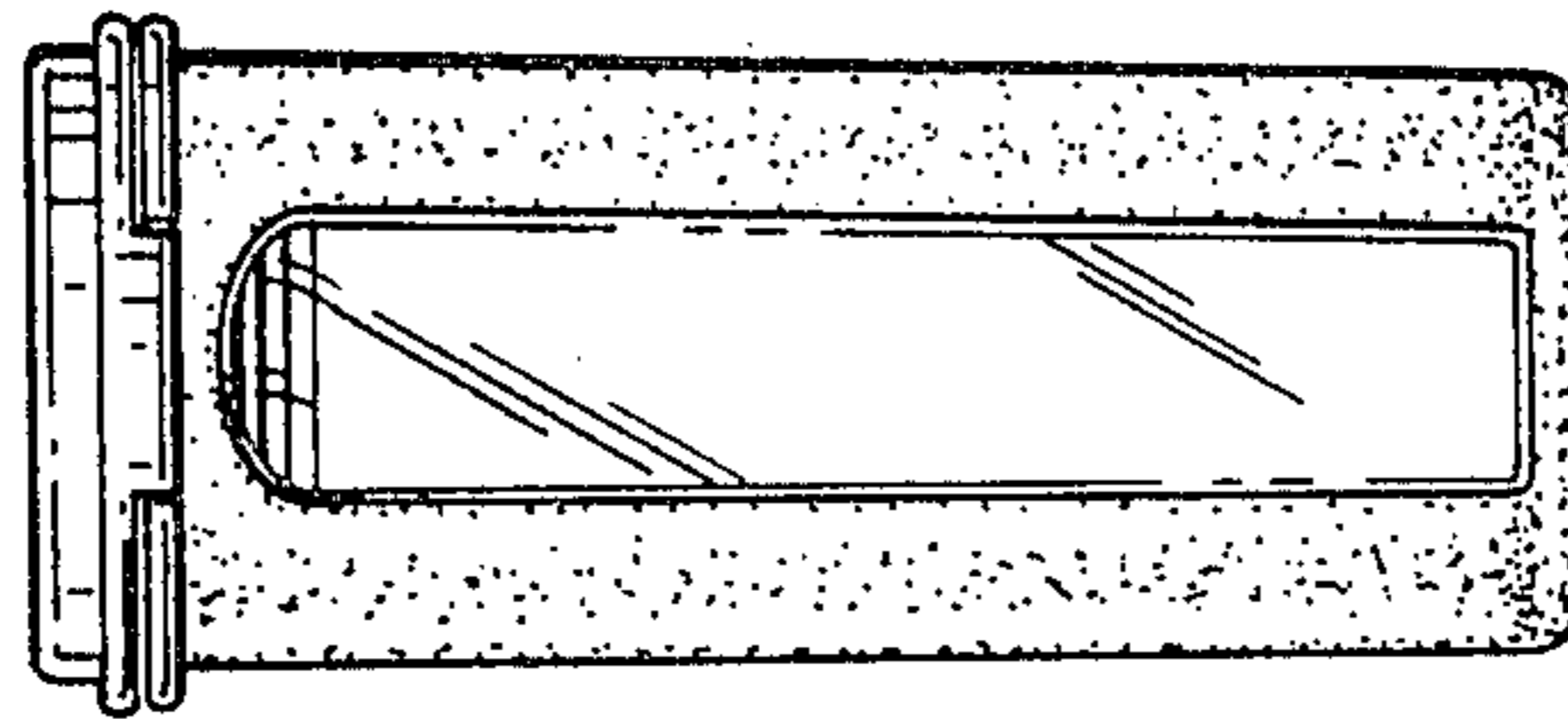

FIG. 16

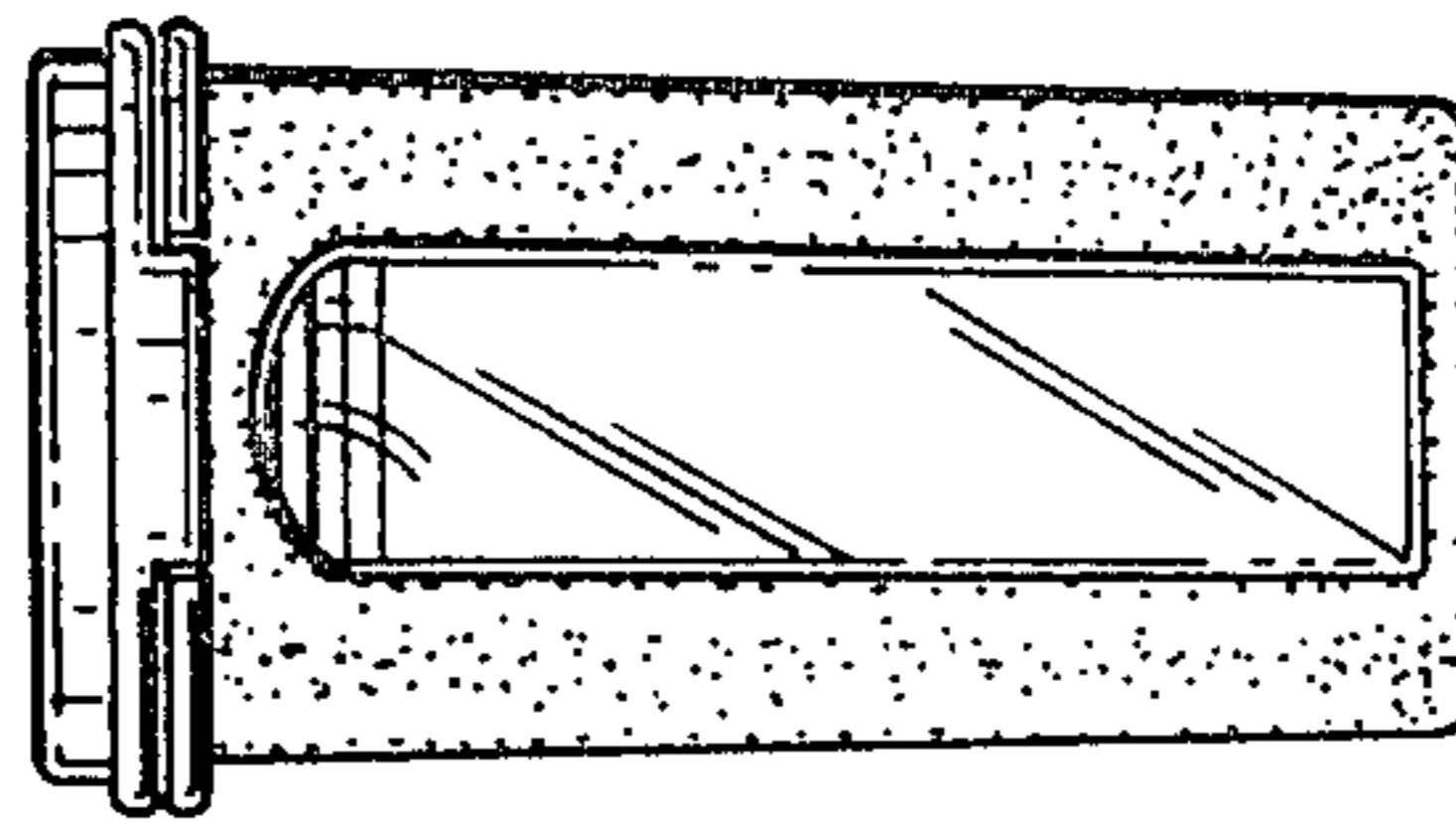

FIG. 13

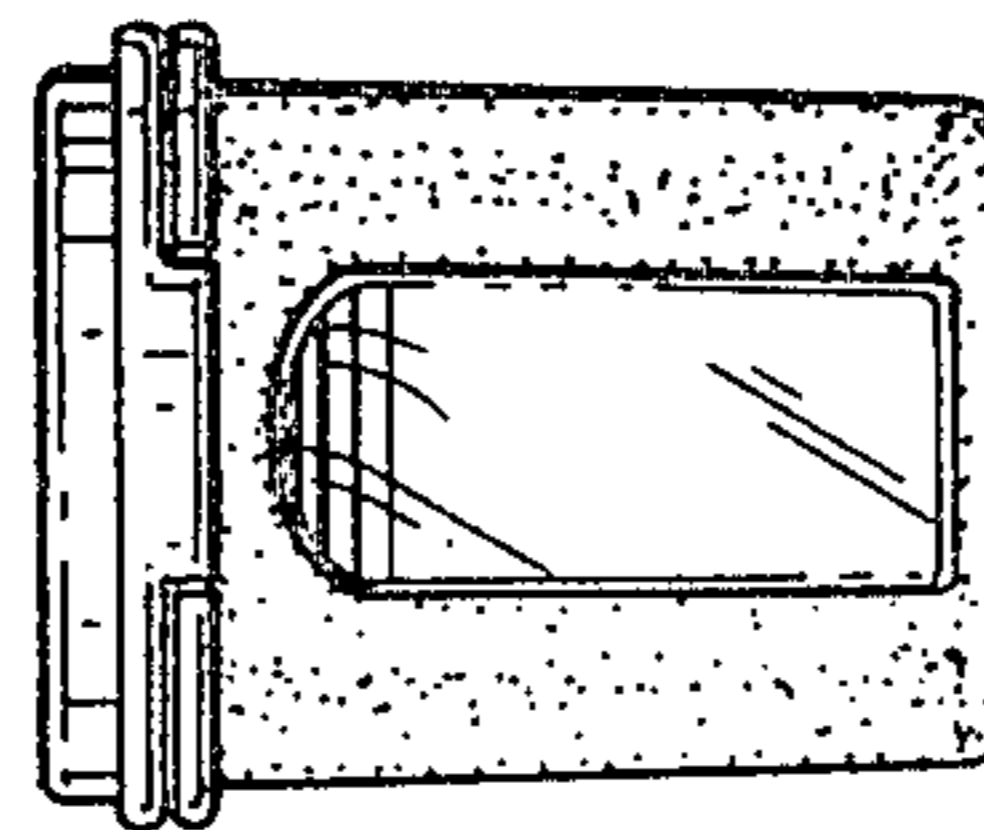

FIG. 15

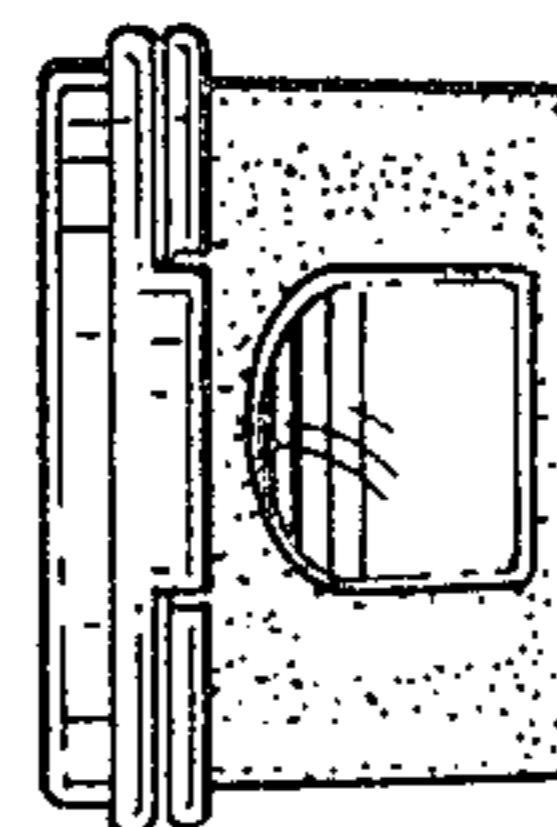

FIG. 14