

United States Patent [19]

Masaki

[11] Patent Number: Des. 276,346

[45] Date of Patent: ** Nov. 13, 1984

[54] **ELECTROPHOTOGRAPHIC COPIER**

[75] Inventor: Nobuo Masaki, Tokyo, Japan

[73] Assignee: Canon Kabushiki Kaisha, Tokyo, Japan

[**] Term: 14 Years

[21] Appl. No.: 404,529

[22] Filed: Aug. 2, 1982

[30] Foreign Application Priority Data

Feb. 8, 1982 [JP] Japan 57-4957

[52] U.S. Cl. D16/31

[58] Field of Search D16/27, 29, 30, 31, D16/32; 355/3 R, 3 SH, 5, 8, 9, 14 SH, 51, 11

[56] References Cited

U.S. PATENT DOCUMENTS

D. 219,312 11/1970 Lamb D16/31
D. 264,345 5/1982 Masaki D16/31

D. 266,253 9/1982 Horikoshi D16/31
D. 266,254 9/1982 Horikoshi D16/31
D. 267,948 2/1983 Kojima D16/31 X
3,813,157 5/1974 Fantozzi 355/51 X

Primary Examiner—Nelson C. Holtje
Attorney, Agent, or Firm—Fitzpatrick, Cella, Harper & Scinto

[57] CLAIM

The ornamental design for an electrophotographic copier, as shown and described.

DESCRIPTION

FIG. 1 is a front elevational view of an electrophotographic copier showing my new design;
FIG. 2 is a rear elevational view thereof;
FIG. 3 is a top plan view thereof;
FIG. 4 is a bottom plan view thereof;
FIG. 5 is a left side elevational view thereof;
FIG. 6 is a right side elevational view thereof;
FIG. 7 is a right-front perspective view thereof.

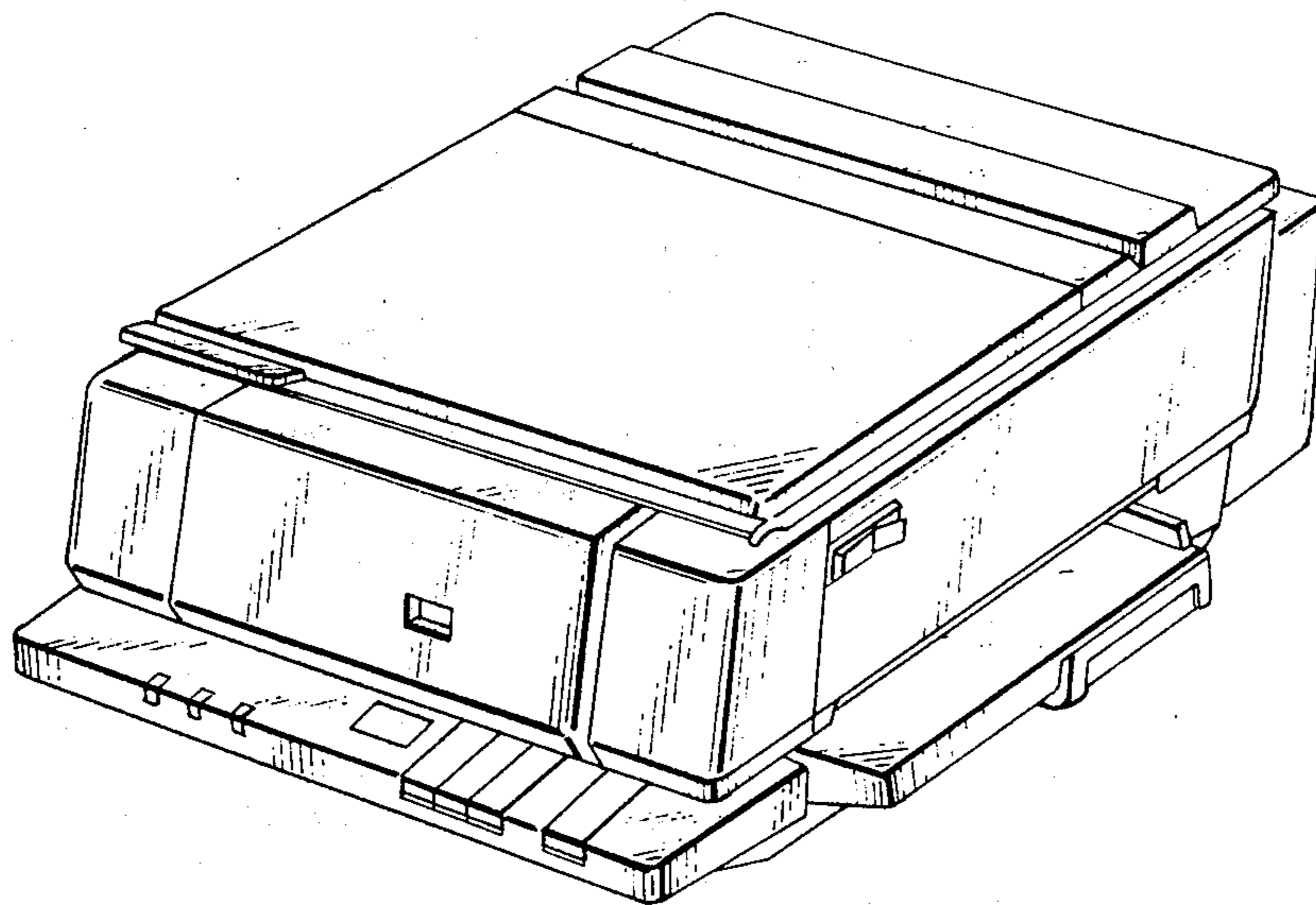

FIG. 1

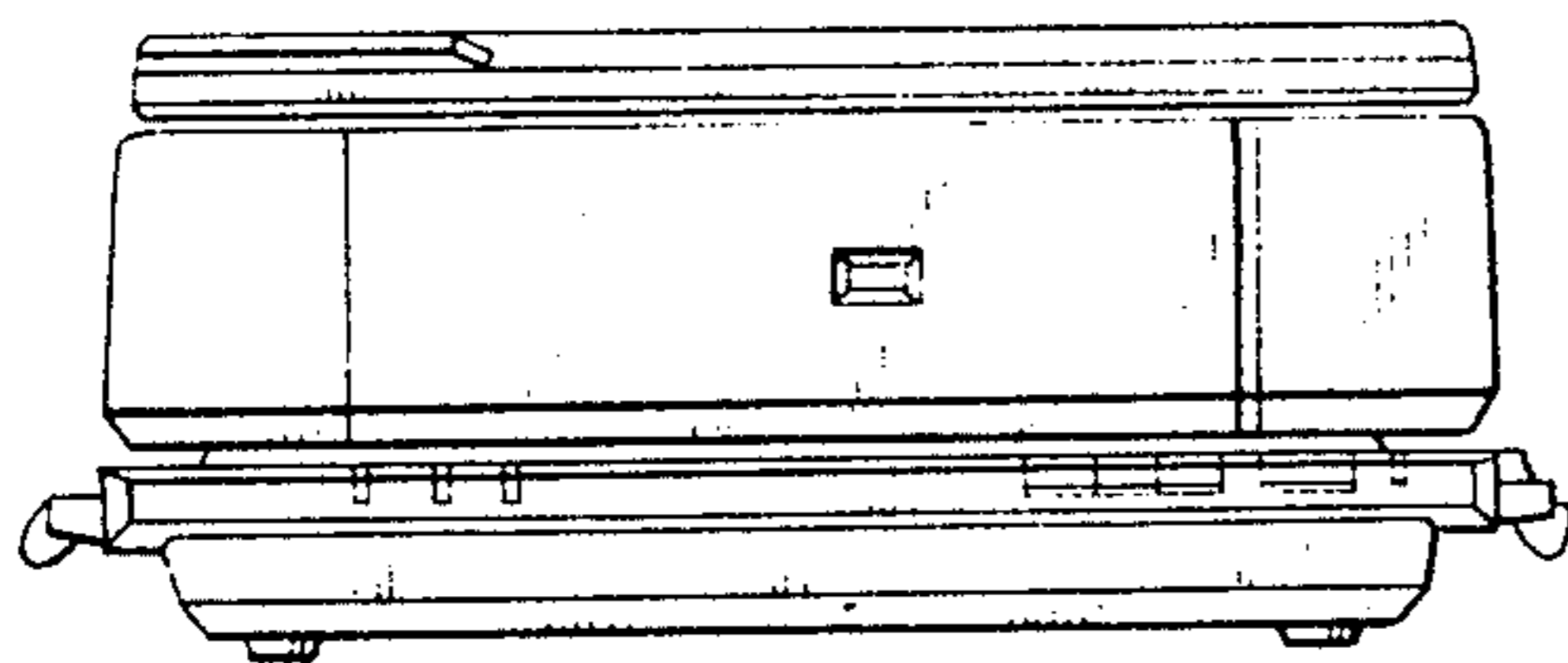

FIG. 2

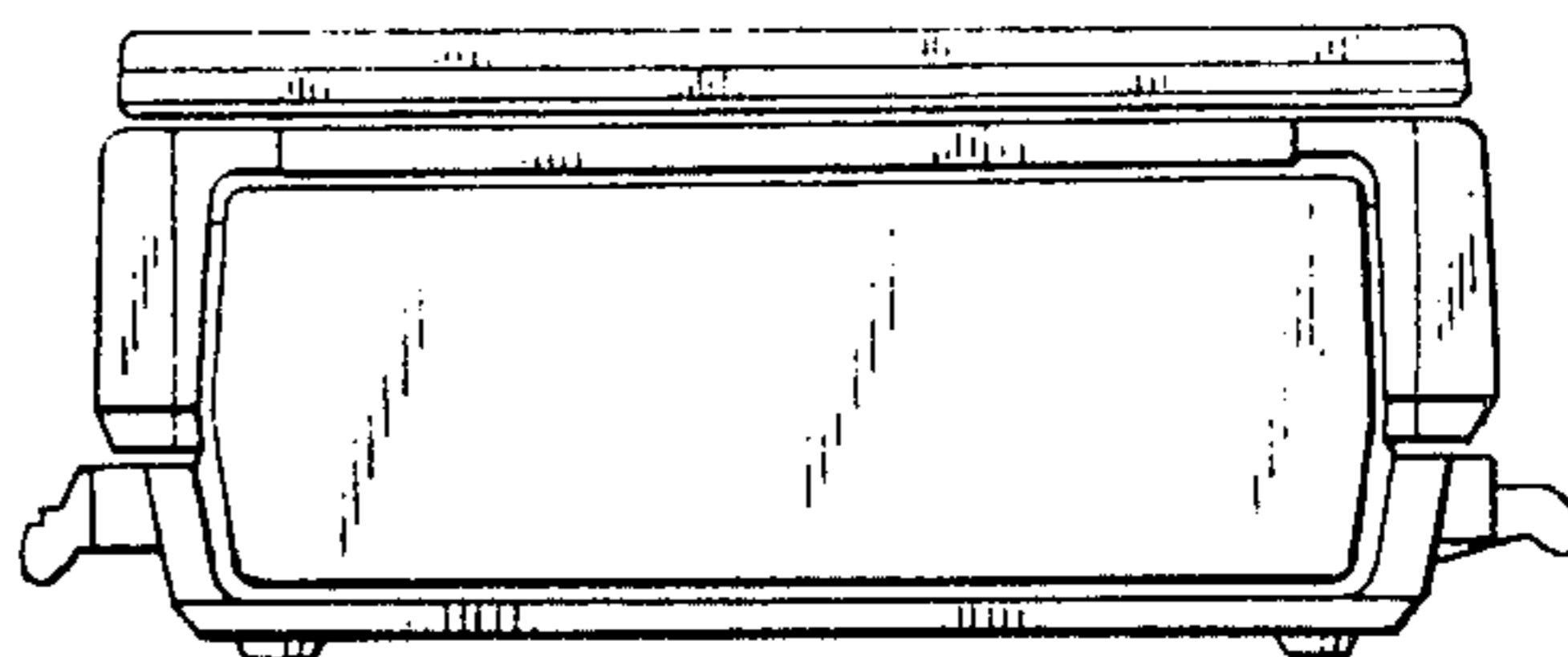

FIG. 3

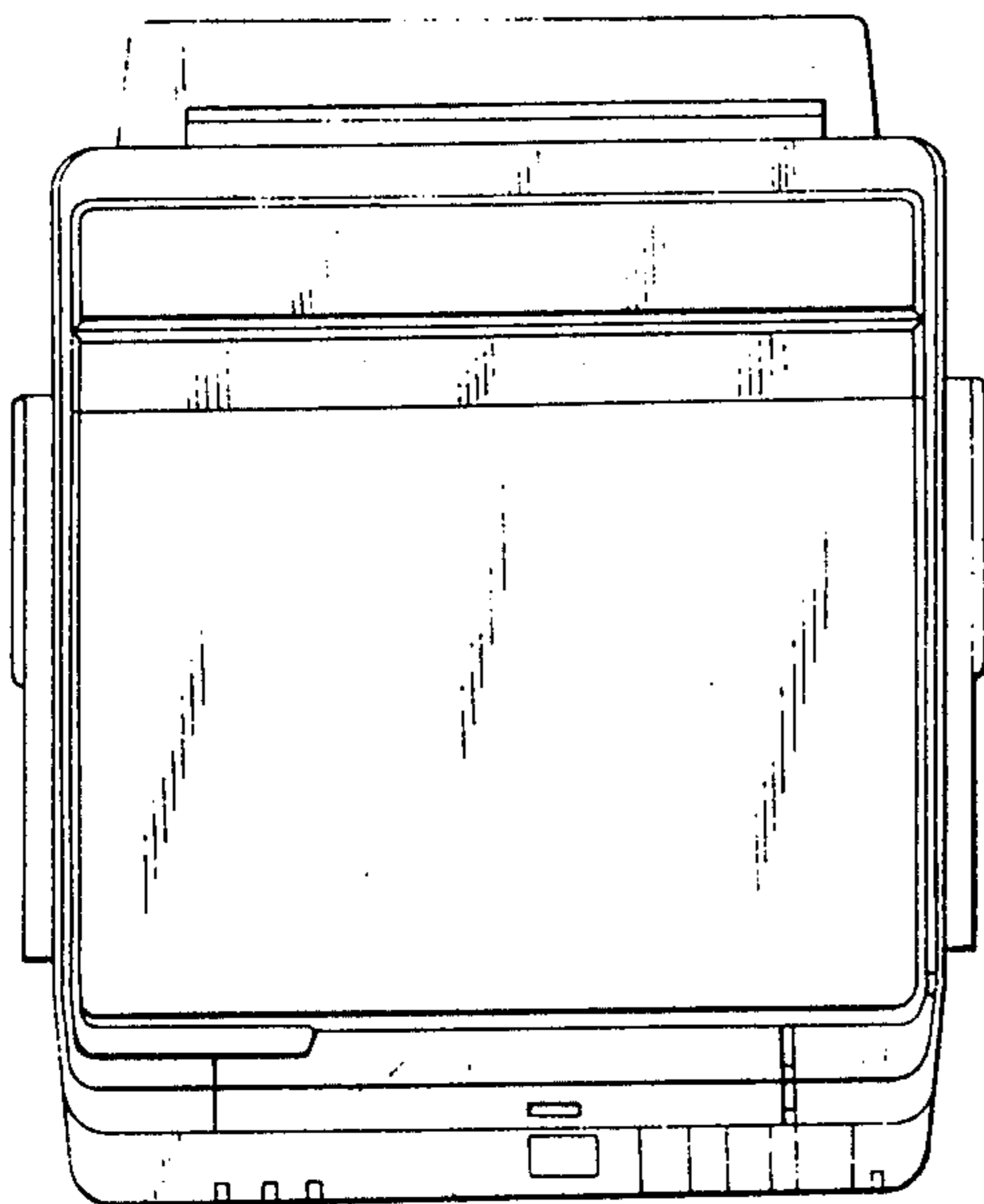

FIG. 4

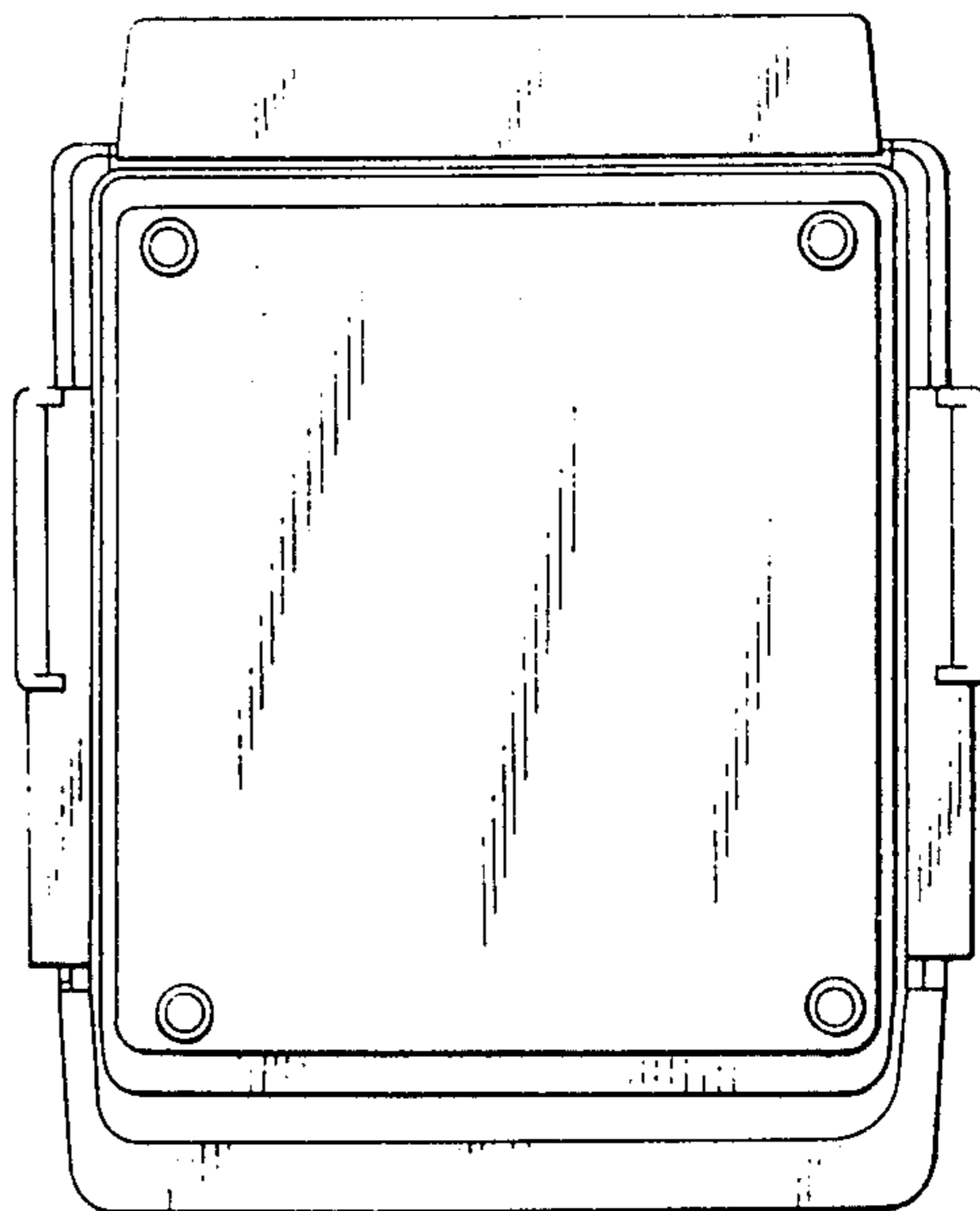

FIG. 5

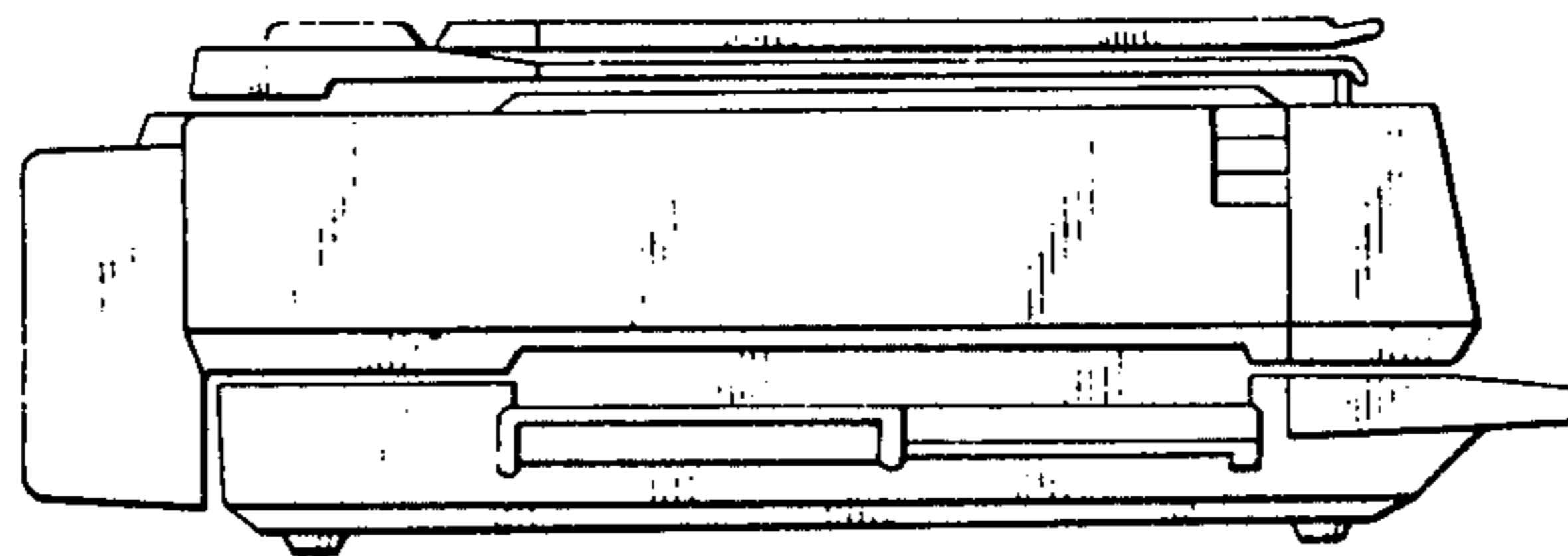

FIG. 6

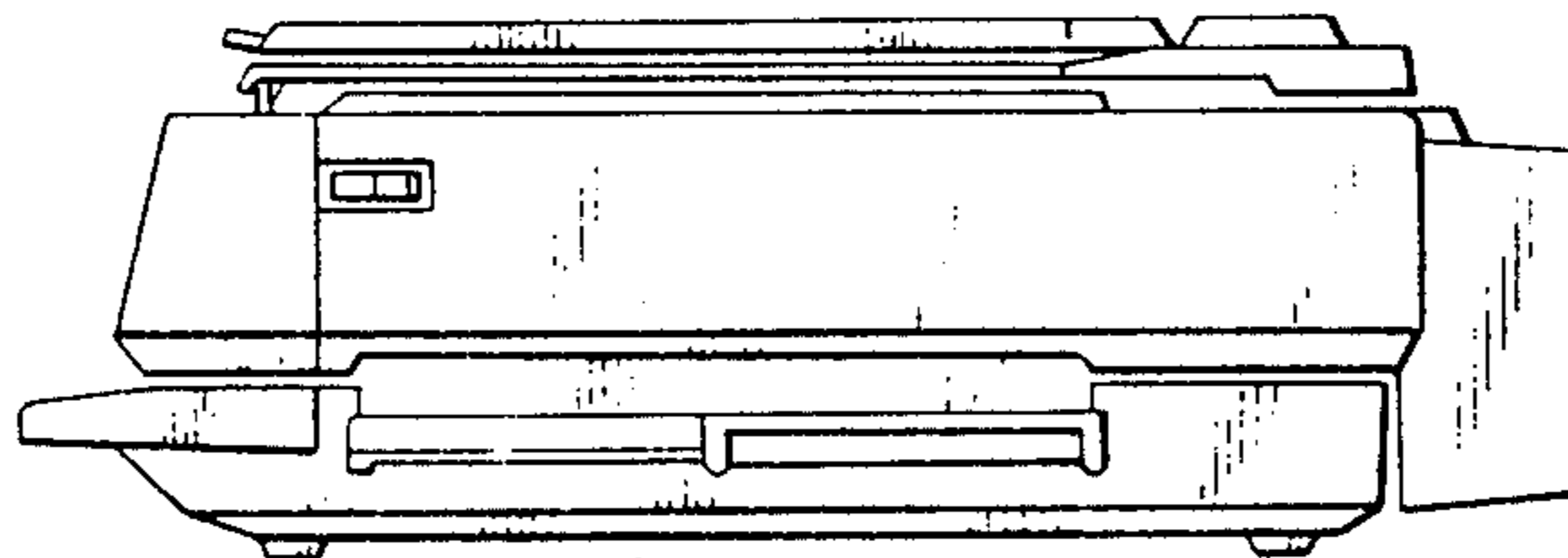

FIG. 7

