

[54] **MOTORCYCLE**

[75] **Inventors: Minoru Morioka, Kawagoe; Tetuo Ogishima, Shiki, both of Japan**

[73] **Assignee: Honda Giken Kogyo Kabushiki Kaisha, Tokyo, Japan**

[**] **Term: 14 Years**

[21] **Appl. No.: 357,323**

[22] **Filed: Mar. 11, 1982**

[30] **Foreign Application Priority Data**

Sep. 11, 1981 [JP]	Japan	56-40261
[52] U.S. Cl.		D12/110
[58] Field of Search	D12/110; 180/219	

[56] **References Cited**

U.S. PATENT DOCUMENTS

D. 268,999 5/1983 Nakano et al. D12/110

OTHER PUBLICATIONS

Cycle World, 2/80, p. 142, Suzuki GS-1100E, top left side of page.

Cycle World, 5/81, p. 51, Honda Motorcycle, bottom of page.

Cycle World, 3/81, p. 103, Honda CB750F.

Primary Examiner—James M. Gandy
Attorney, Agent, or Firm—Armstrong, Nikaido, Marmelstein & Kubovcik

[57] **CLAIM**

The ornamental design for a motorcycle, as shown and described.

DESCRIPTION

FIG. 1 is a left side elevational view of a motorcycle, showing our new design;

FIG. 2 is a right side elevational view thereof;

FIG. 3 is a front elevational view thereof;

FIG. 4 is a rear elevational view thereof;

FIG. 5 is a top plan view thereof;

FIG. 6 is a bottom plan view thereof; and

FIG. 7 is a perspective view thereof.

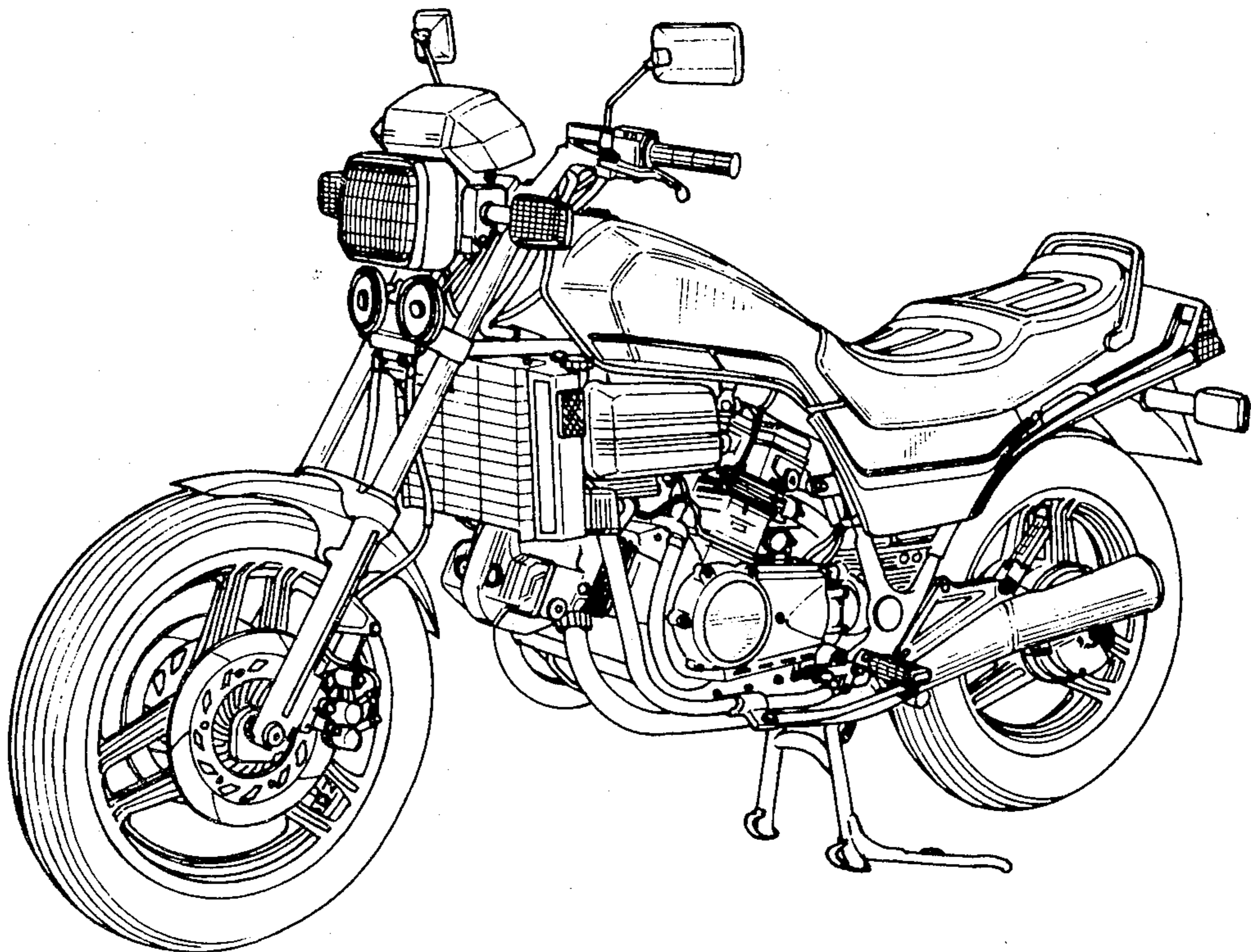

FIG. 1

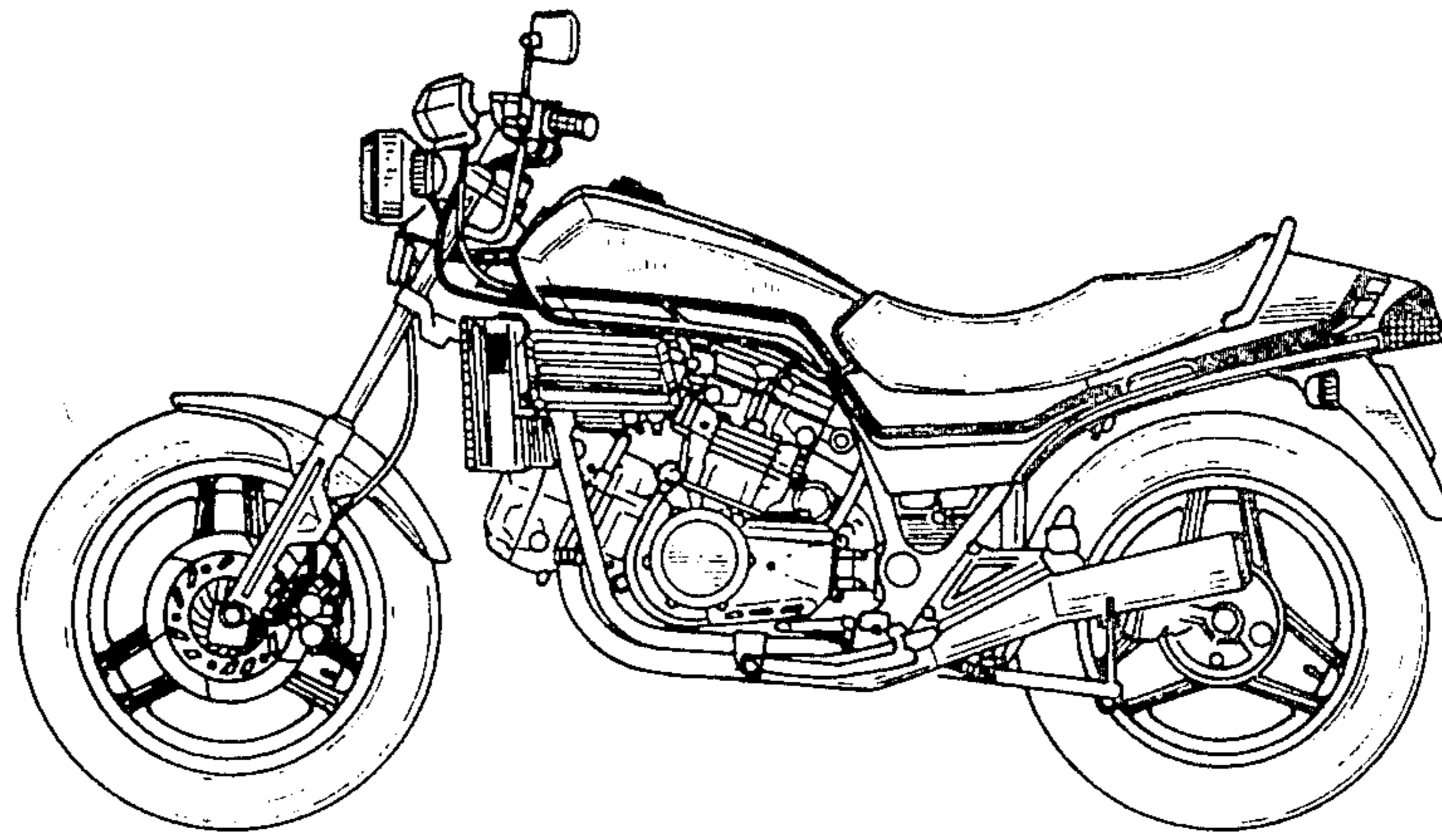

FIG. 2

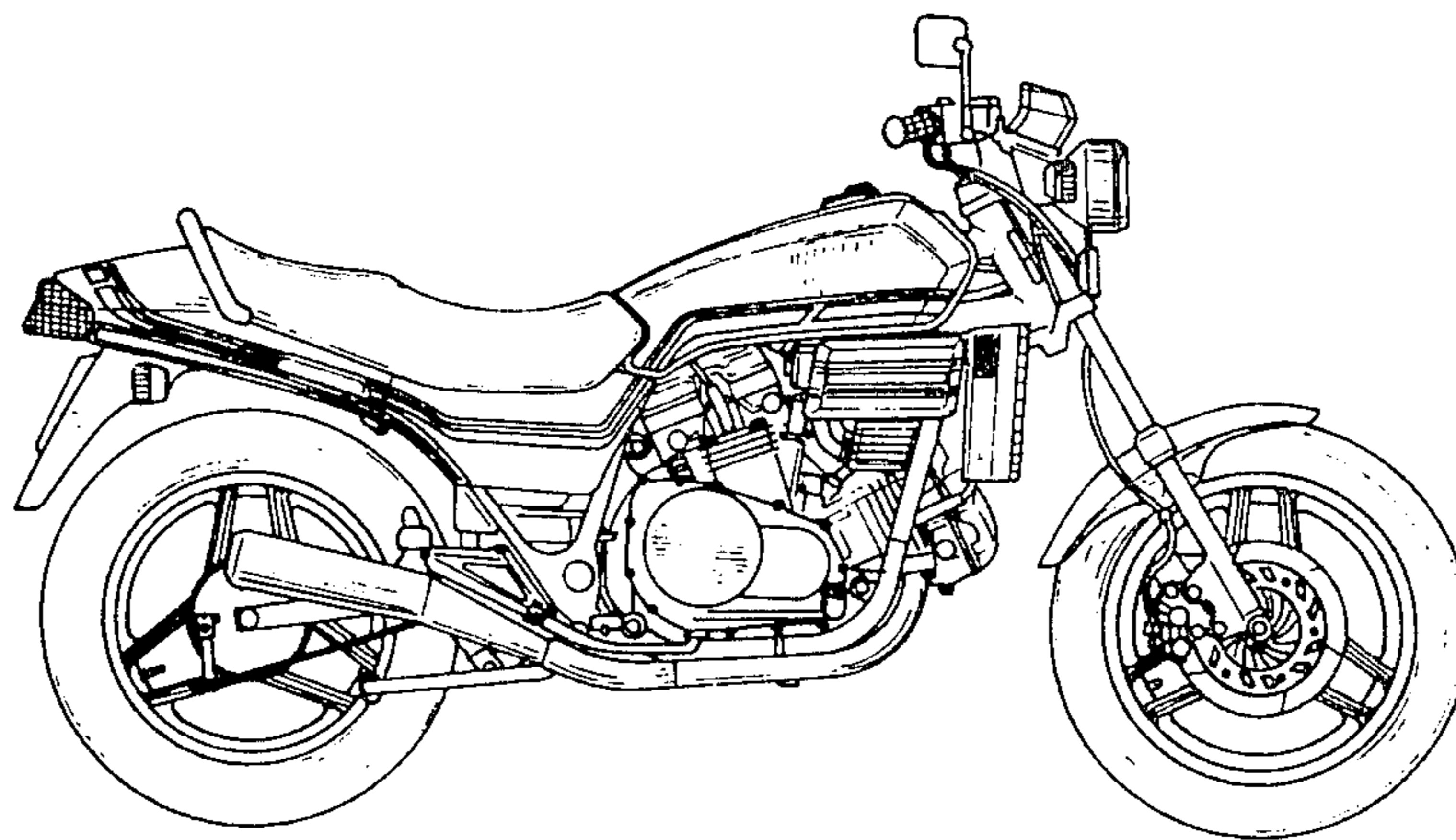

FIG. 3

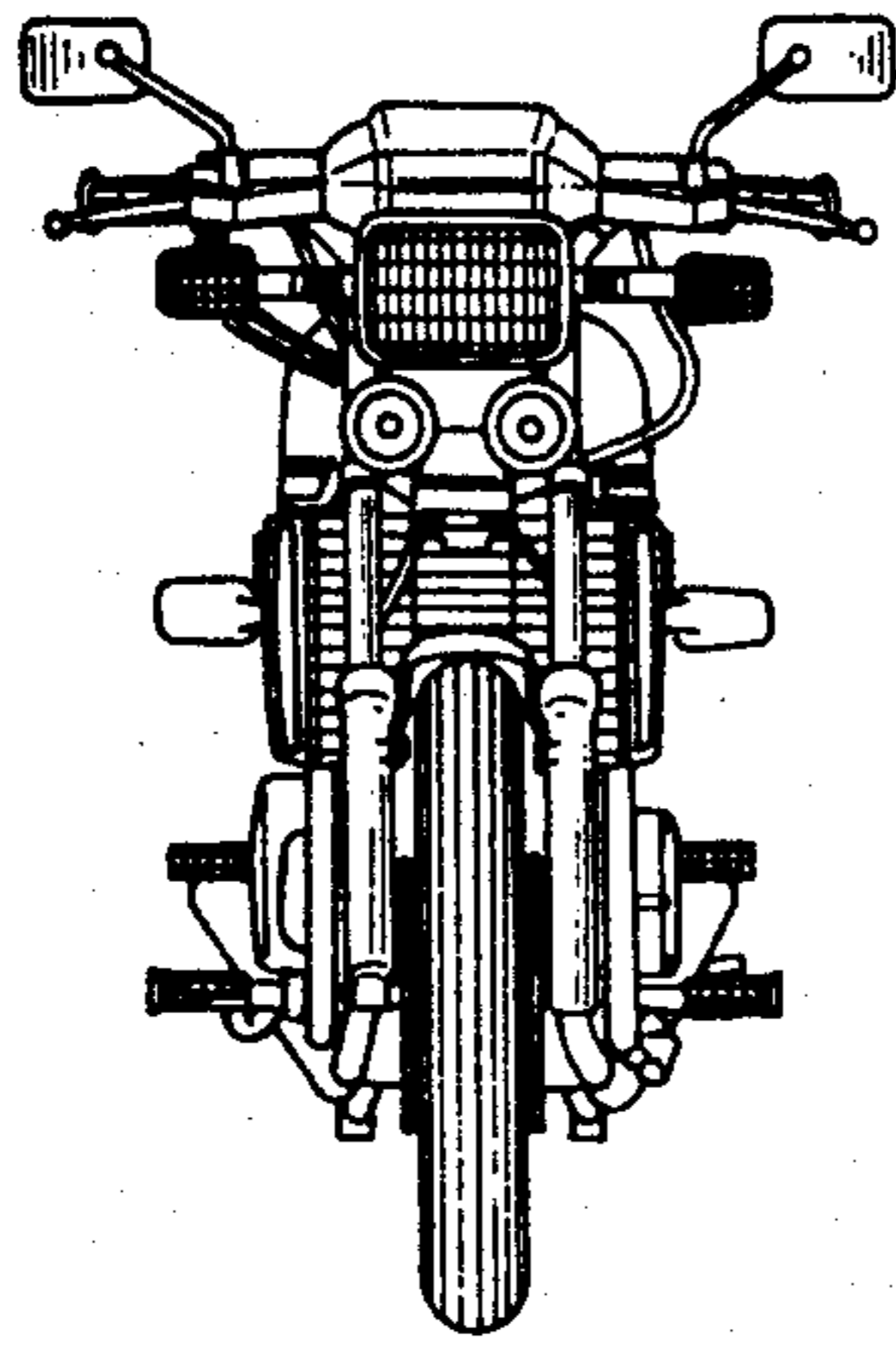

FIG. 4

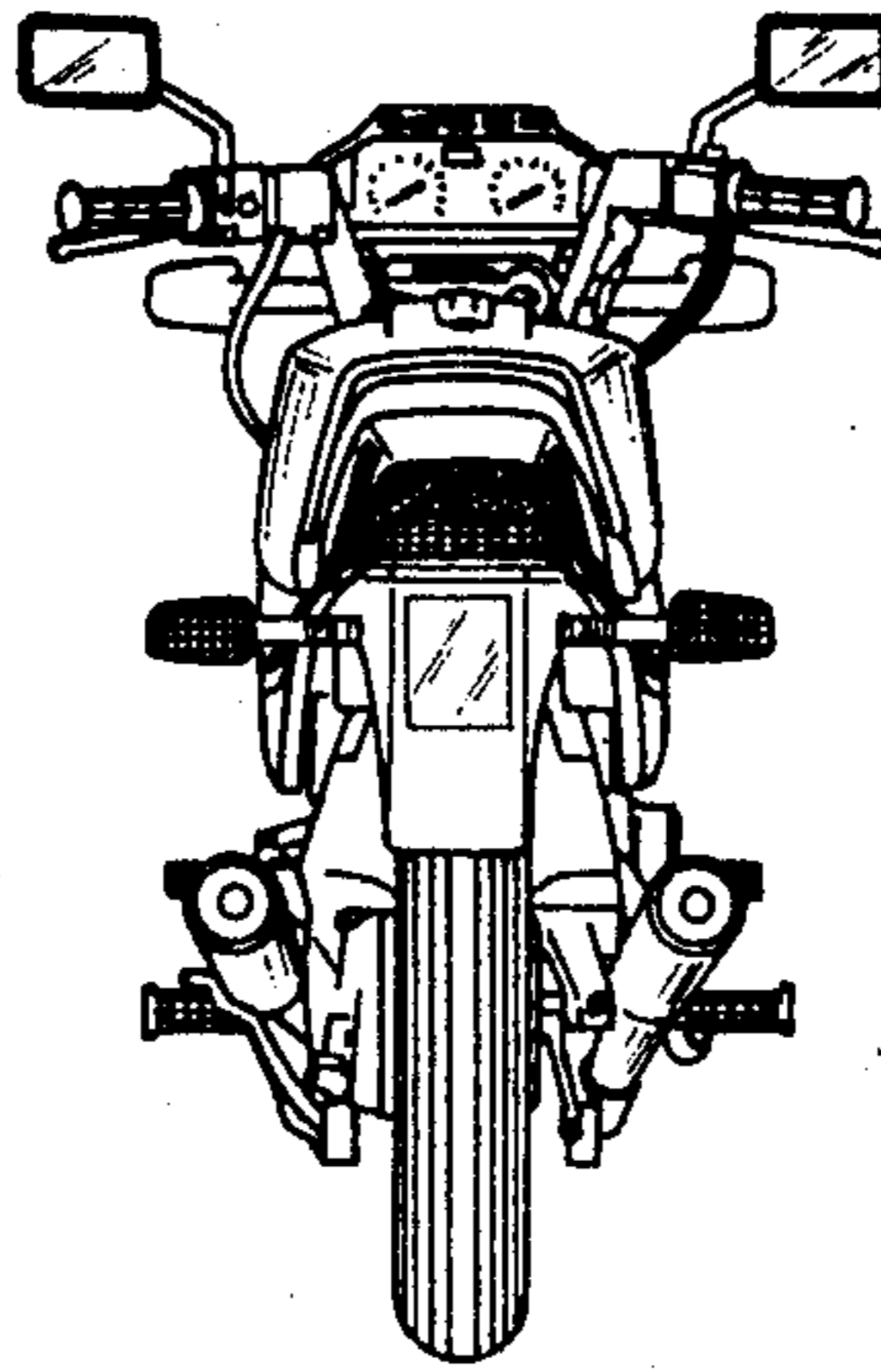

FIG. 5

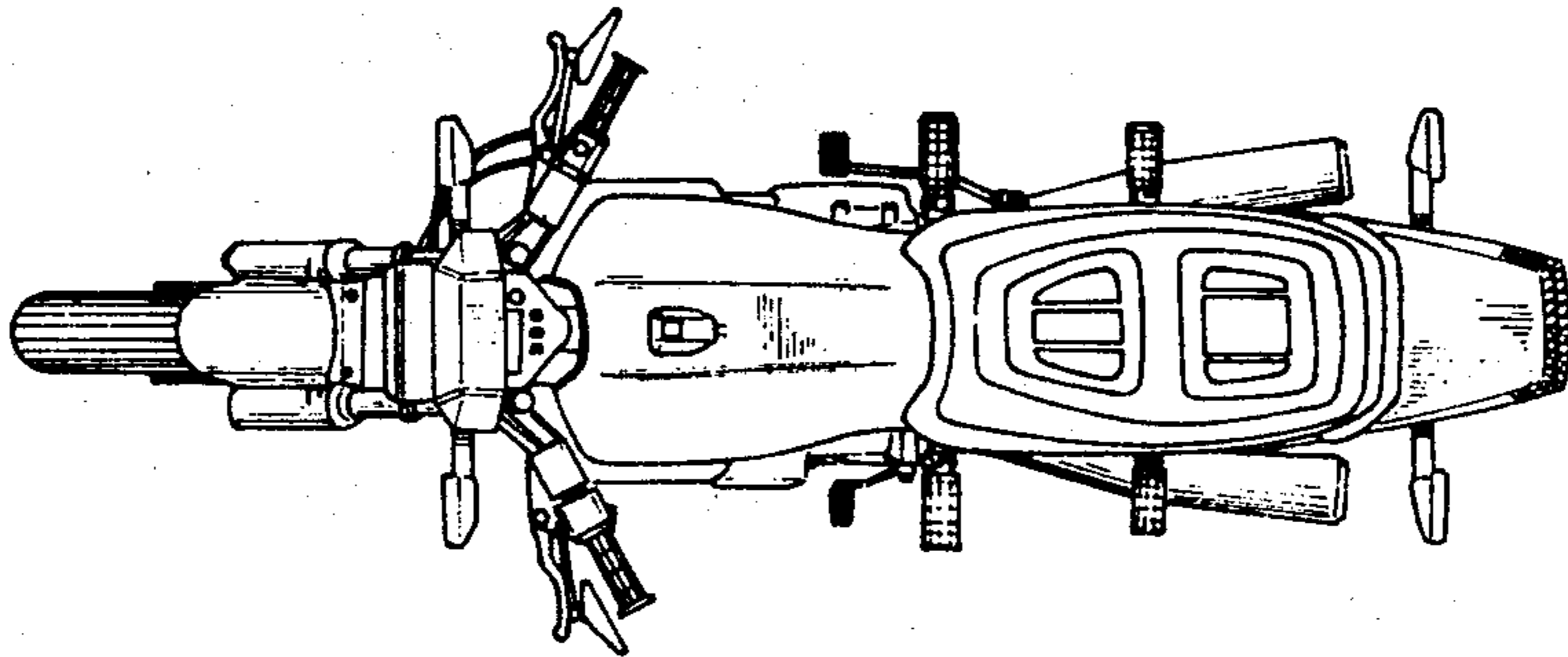

FIG. 6

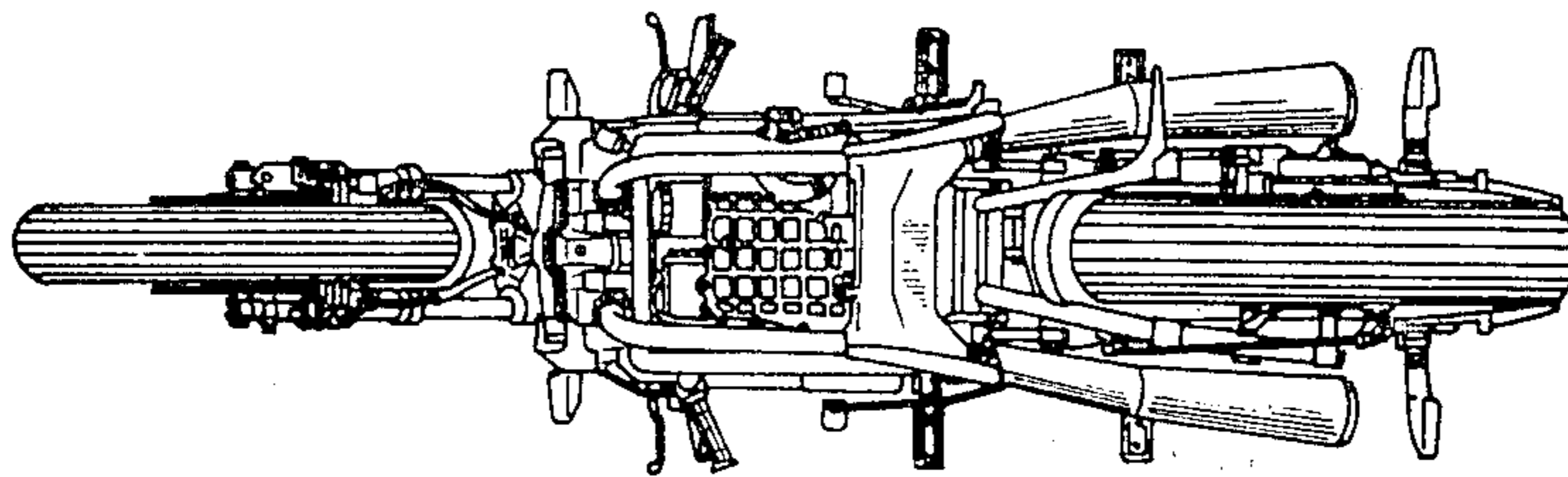

FIG. 7

