

[54] BAR SINK FAUCET

[75] Inventor: Charles D. Miller, Kansas City, Mo.

[73] Assignee: Broadway Industries, Inc., Kansas City, Mo.

[**] Term: 14 Years

[21] Appl. No.: 382,923

[22] Filed: May 28, 1982

[52] U.S. Cl. D23/25

[58] Field of Search D23/23-32;
4/191-192; 137/606, 801

[56] References Cited

U.S. PATENT DOCUMENTS

D. 53,558	7/1919	Bloch	D23/25
D. 77,024	11/1928	Mueller	D23/24
D. 87,328	7/1932	Brotz	D23/26
D. 200,622	3/1965	Whitener, Jr.	D23/32
D. 243,240	2/1977	Dreibelbis	D23/25

OTHER PUBLICATIONS

Delta-Delex Faucets Cat. (c) 1976, p. 21, Model 2170 and 2171.

Catalog Page of the Chicago Faucet Company, 2100 South Nuclear Drive, Des Plaines, Ill. 60018.

Catalog Pages 43 and 44 of Phylrich International, 1000 North Orange Drive, Los Angeles, Calif. 90038.

Catalog of Artistic Brass No. ACA102, front page, back page 39, 3136 East 11th St., Los Angeles, Calif. 90023.

Primary Examiner—James R. Largen
Attorney, Agent, or Firm—Schmidt, Johnson, Hovey & Williams

[57] CLAIM

The ornamental design for a bar sink faucet, as shown and described.

DESCRIPTION

FIG. 1 is a front elevational view of a bar sink faucet embodying my new design;
 FIG. 2 is a right side elevational view thereof;
 FIG. 3 is a rear elevational view thereof;
 FIG. 4 is a left side elevational view thereof;
 FIG. 5 is a top plan view thereof;
 FIG. 6 is a right side elevational view of a modified form of the bar sink faucet shown in FIG. 1, the left side being a mirror image of the right side shown;
 FIG. 7 is a front elevational view of FIG. 6;
 FIG. 8 is a top plan view of FIG. 6;
 FIG. 9 is a right side elevational view of a second modified form of the bar sink faucet shown in FIG. 1, the left side being a mirror image of the right side shown;
 FIG. 10 is a top plan view of FIG. 9; and
 FIG. 11 is a front elevational view of FIG. 9.

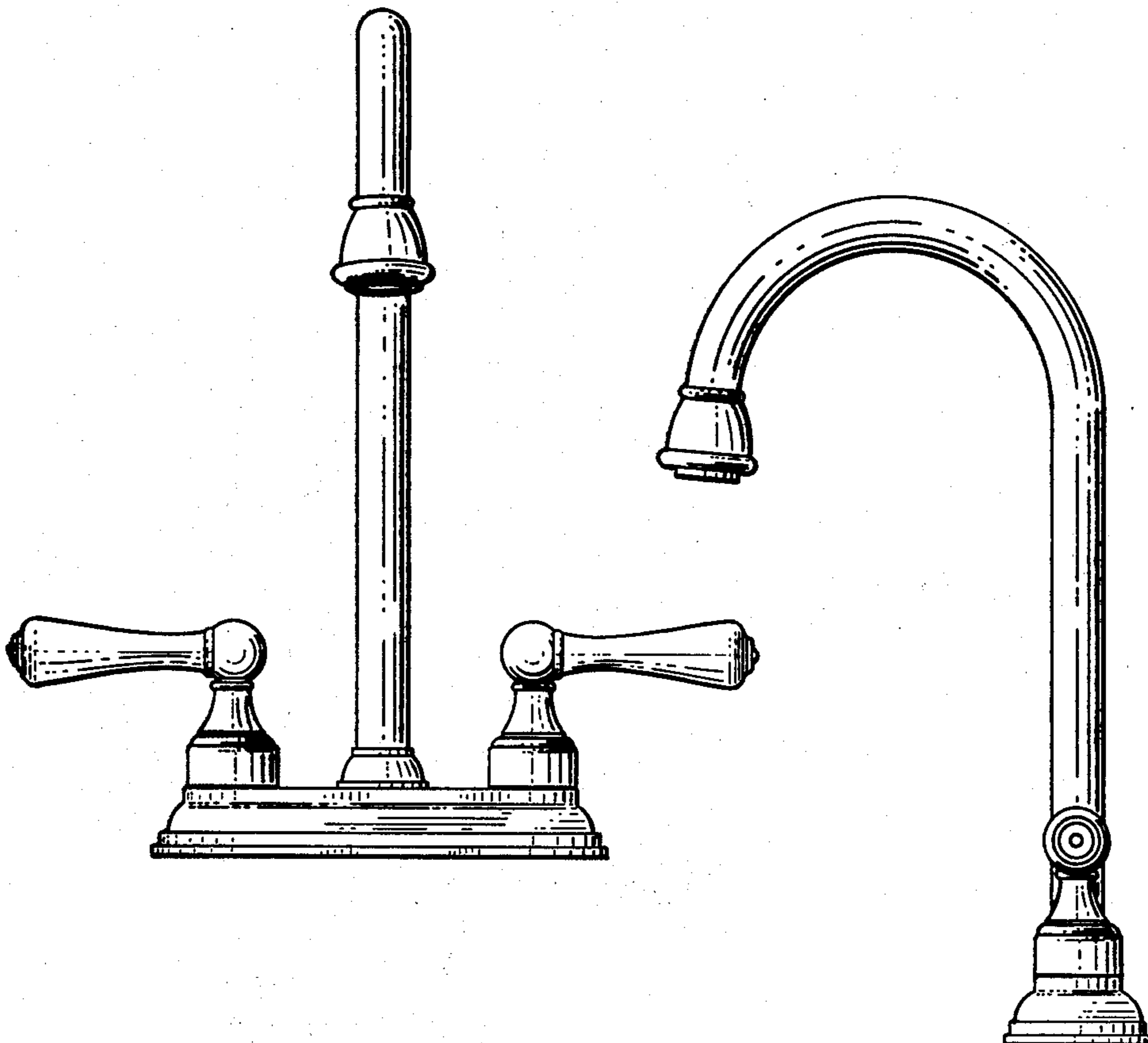

Fig. 1.

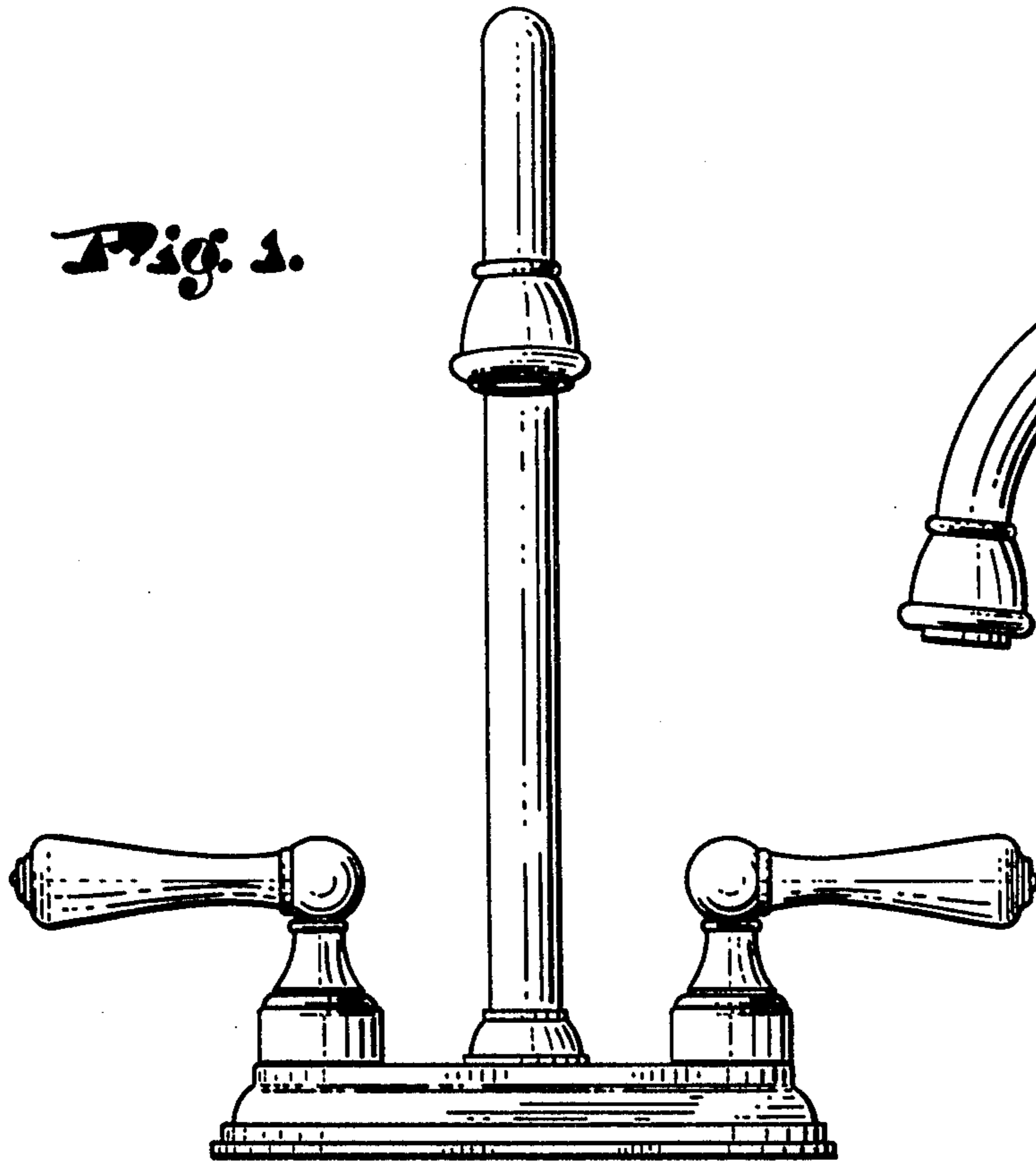

Fig. 2.

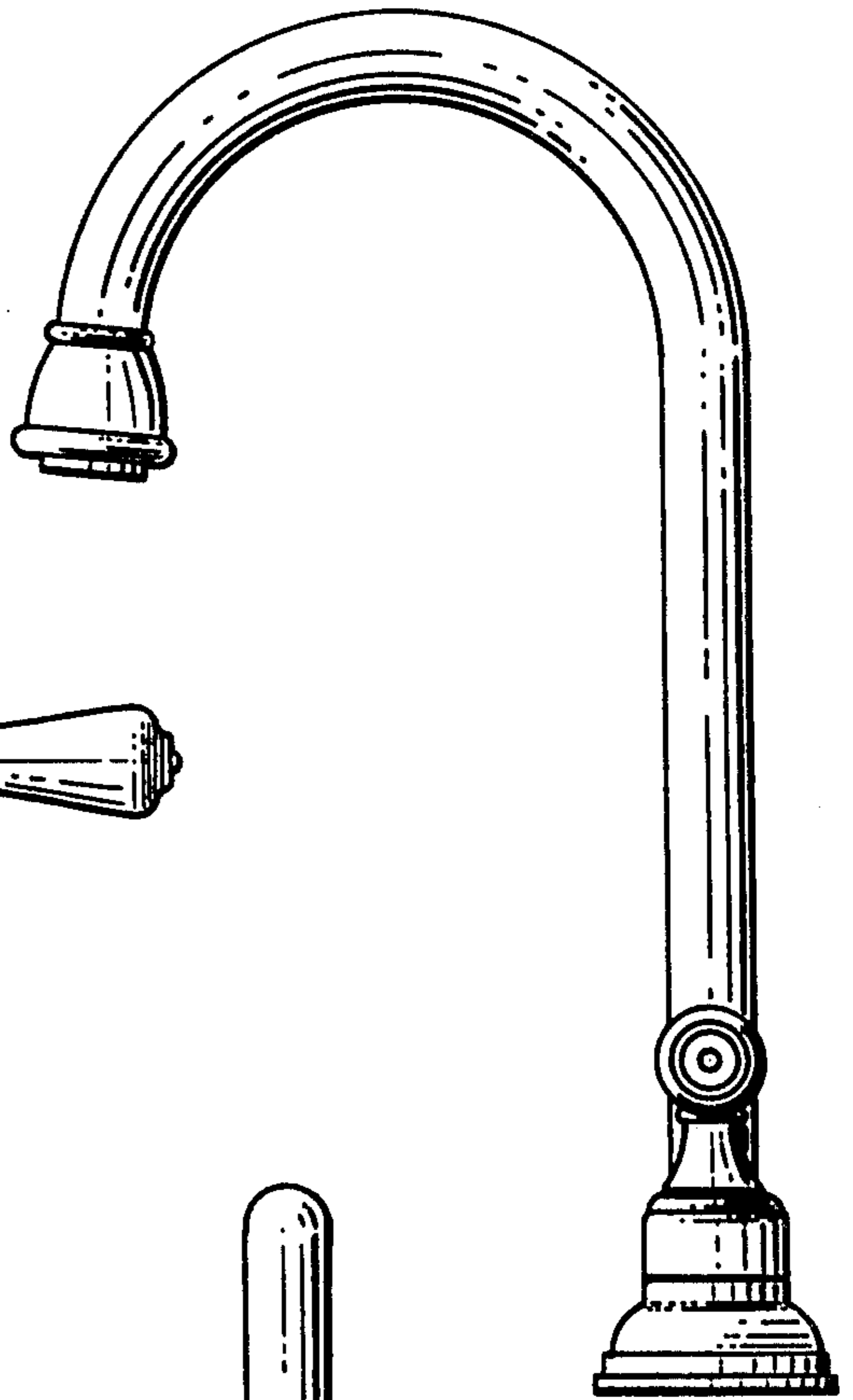

Fig. 4.

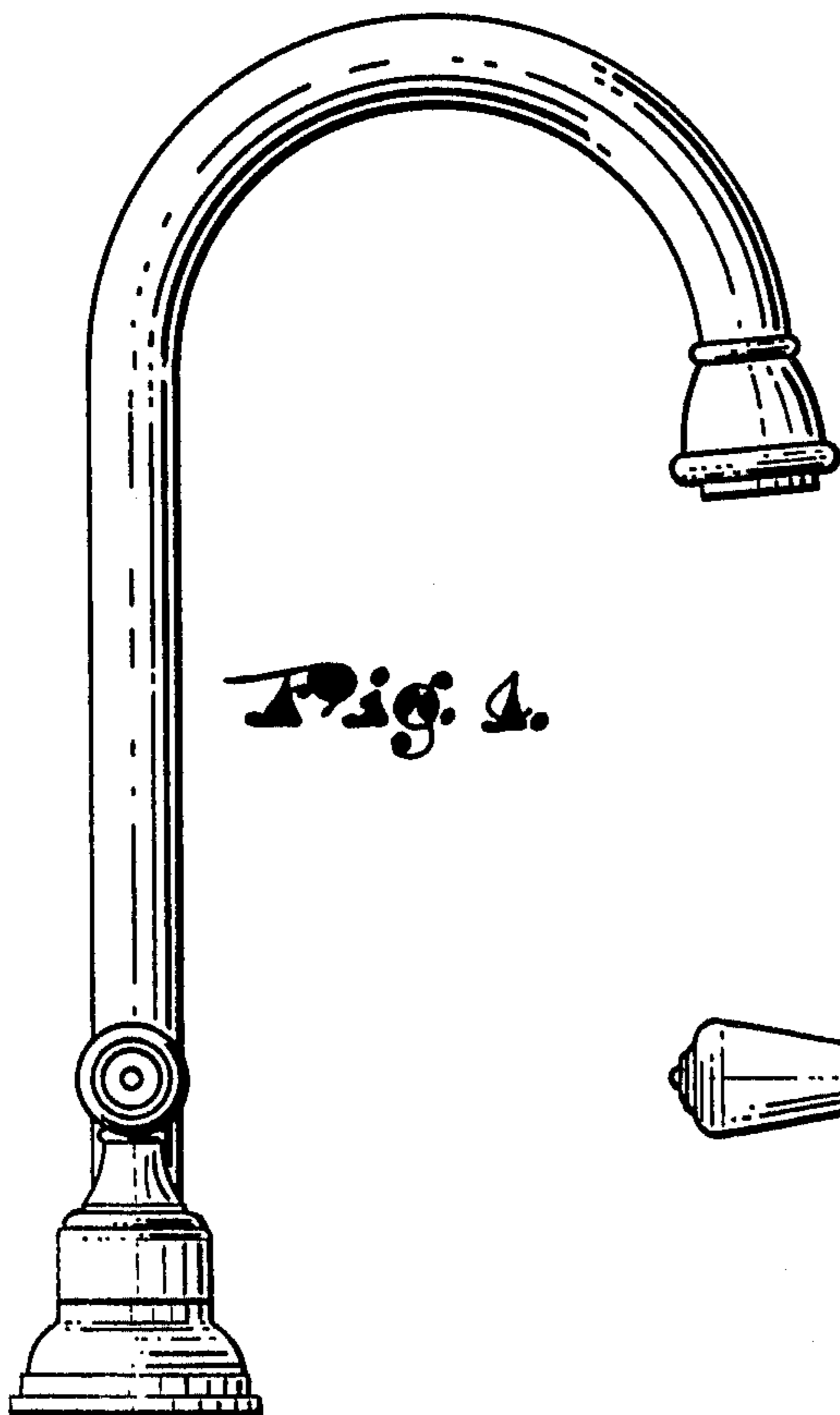
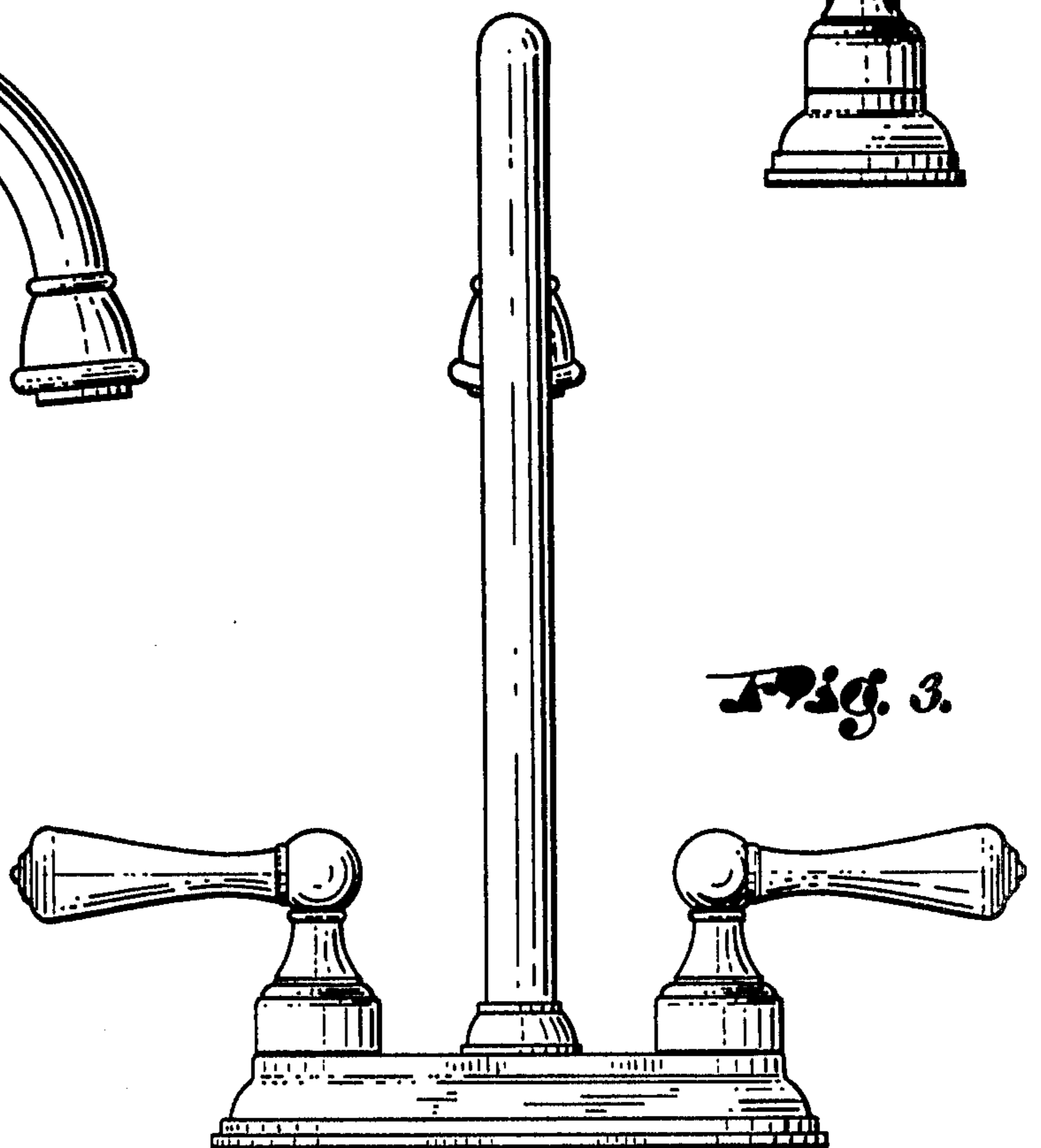

Fig. 3.



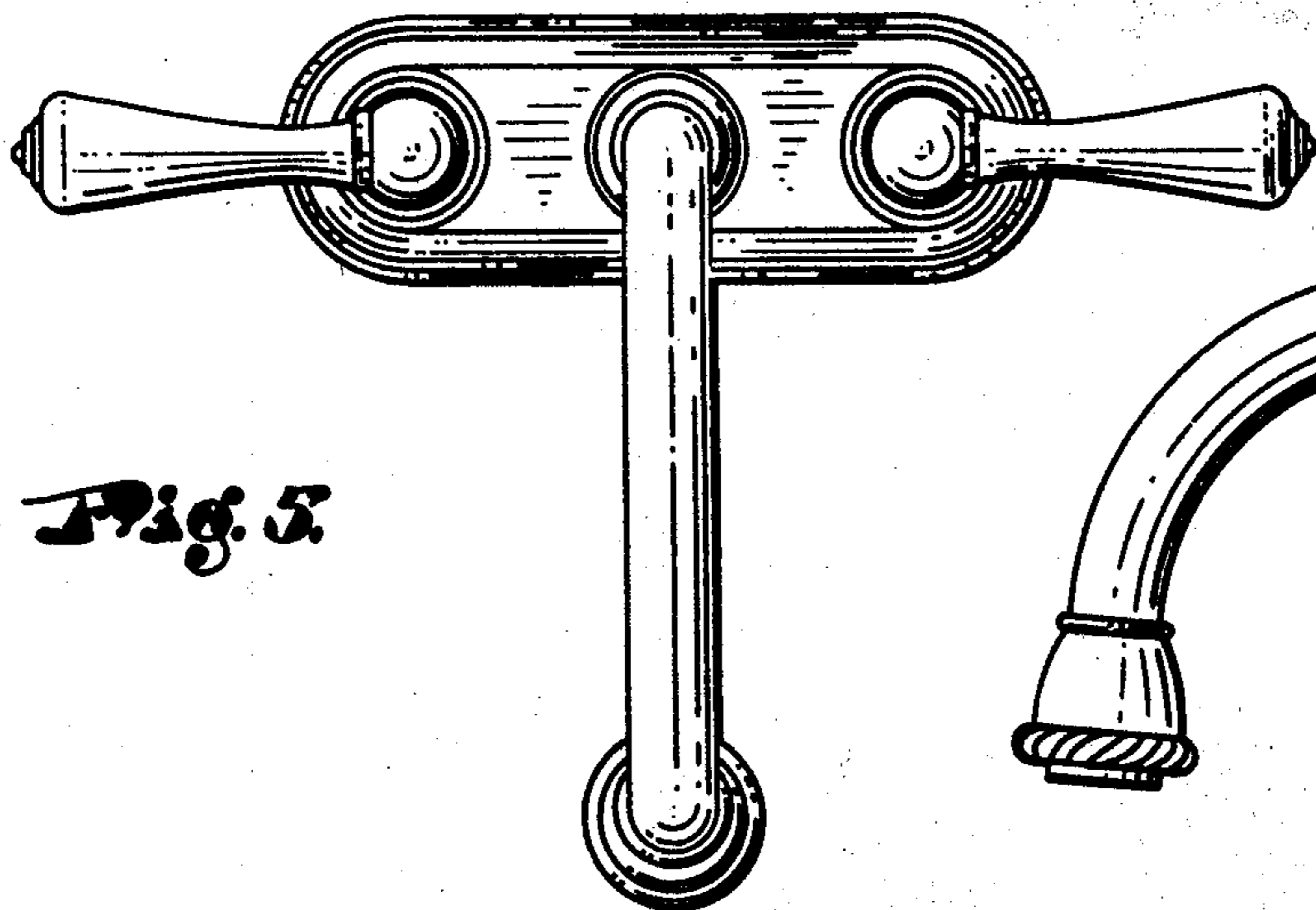

Fig. 5.

Fig. 6.

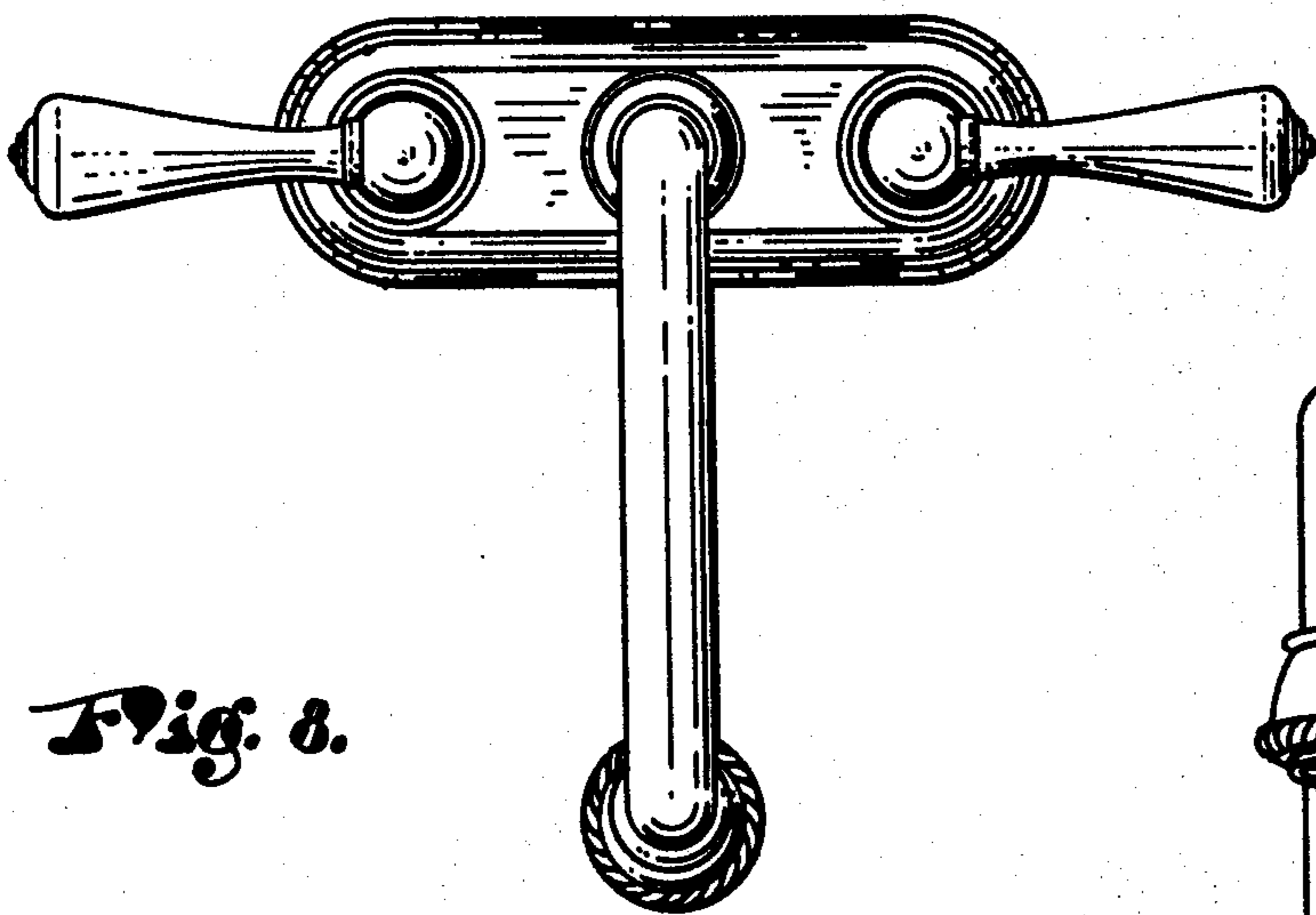
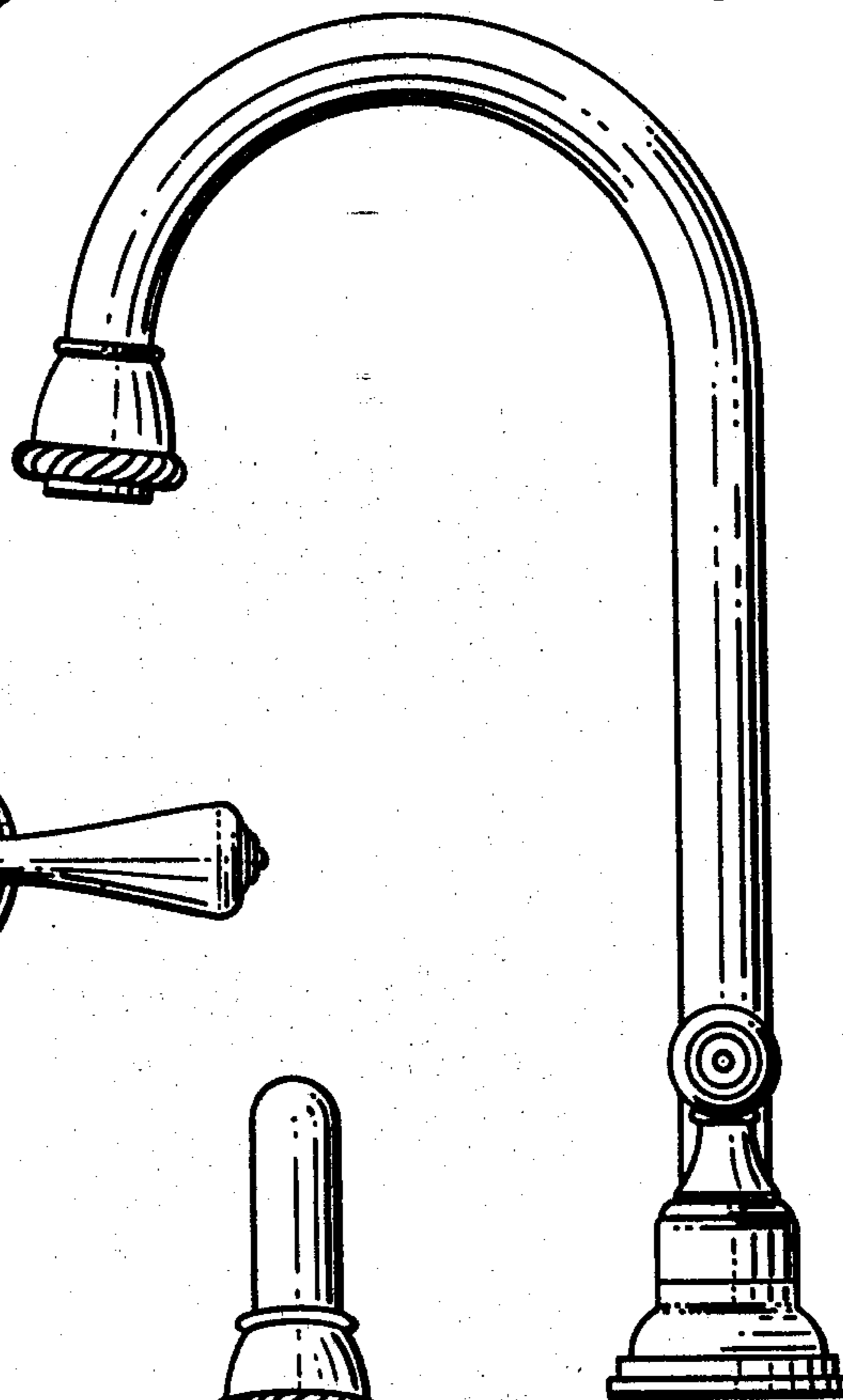

Fig. 8.

Fig. 7.

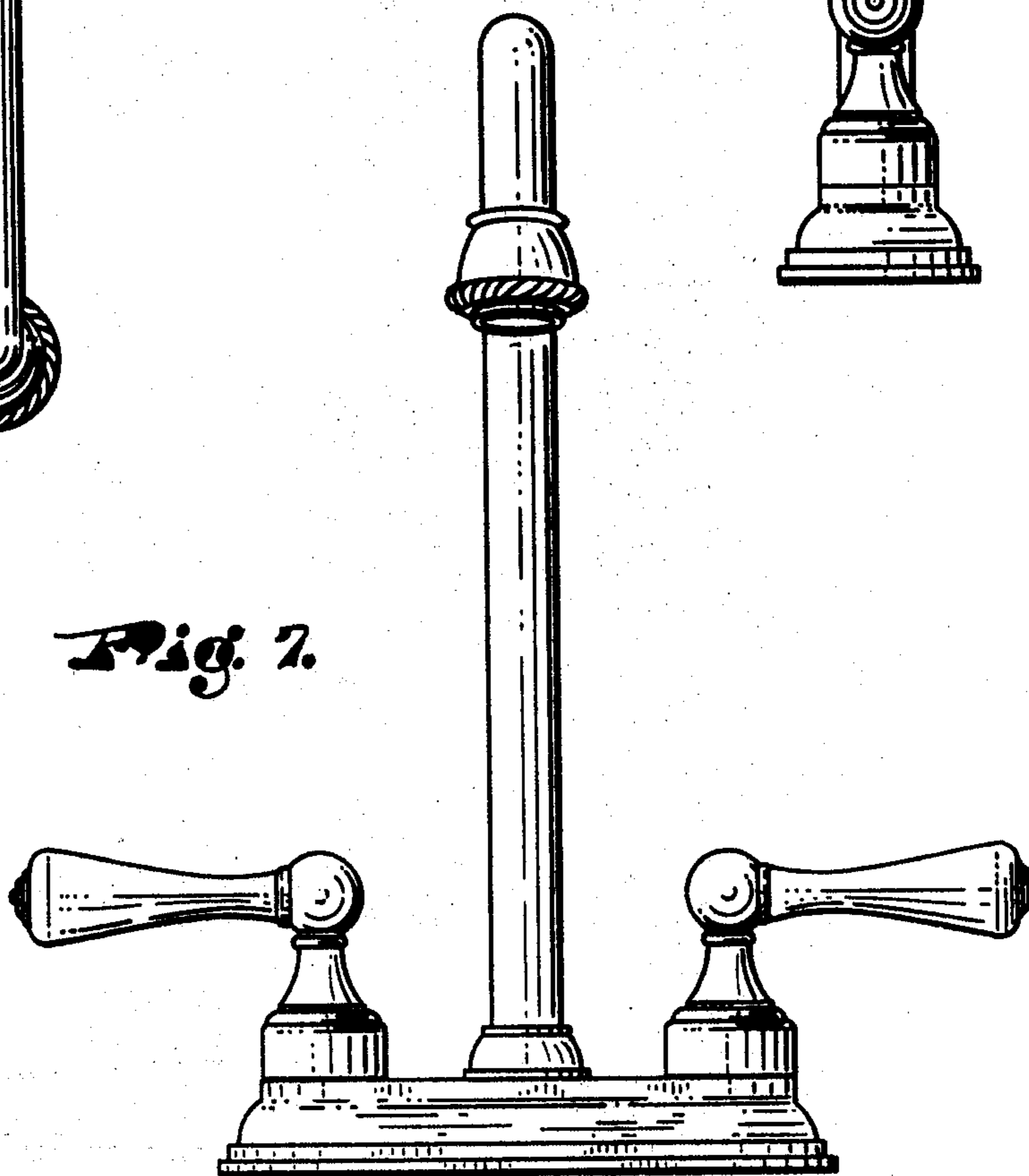

Fig. 9.

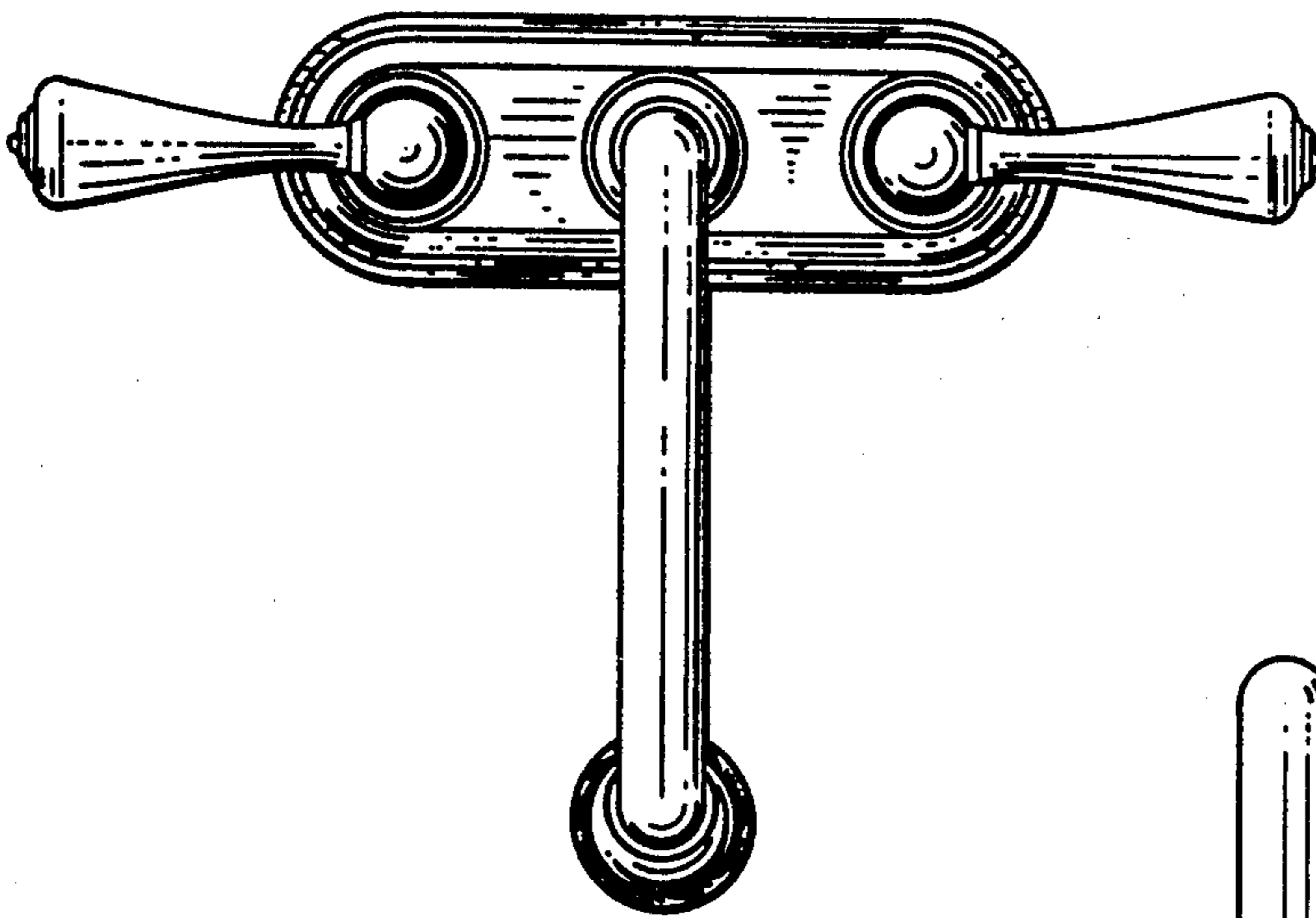
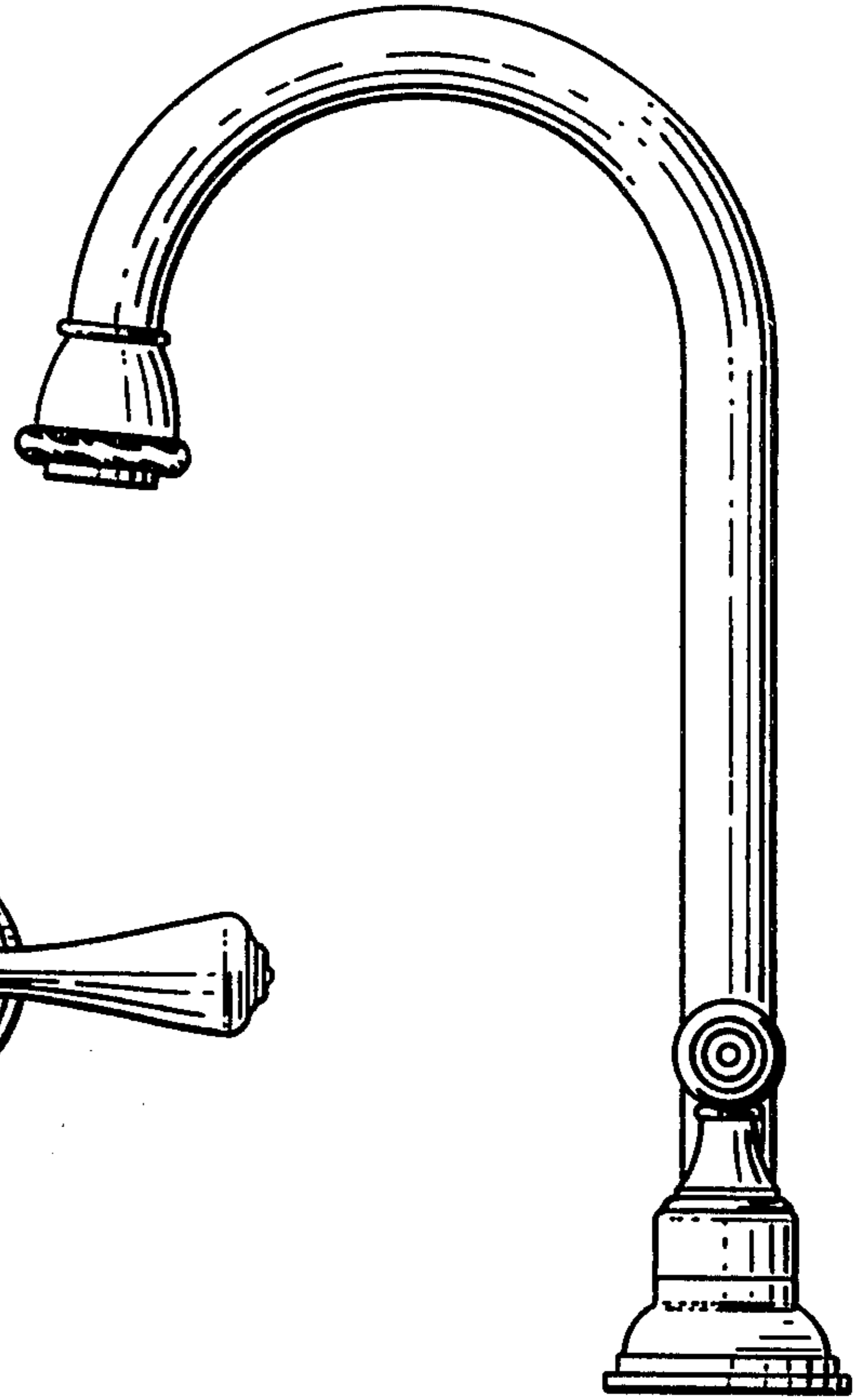

Fig. 10.

Fig. 11.

