

[54] SEWING MACHINE

[76] Inventor: Yoshihide Yoneda, 7-401, 53, Taguchiyama 1-chome, Hirakata-shi, Osaka, Japan

[**] Term: 14 Years

[21] Appl. No.: 333,187

[22] Filed: Dec. 21, 1981

[30] Foreign Application Priority Data

Dec. 9, 1981 [JP] Japan 56/54389
[52] U.S. Cl. D15/70
[58] Field of Search D15/66, 68, 69, 70, D15/72; 112/258, 259, 63

[56] References Cited

U.S. PATENT DOCUMENTS

D. 221,308 7/1971 Grange D15/69
D. 247,901 5/1978 Fresard D15/70
D. 250,649 12/1978 Hirano D15/70
4,099,474 7/1978 Hamlett et al. 112/258

OTHER PUBLICATIONS

Better Homes and Gardens, Mar. 1980, p. 33; "Singer" Sewing Machine on page.
Sears Fall & Winter, 1981, p. 851; "Kenmore" Sewing Machine, top right of page.

Primary Examiner—Bernard Ansher
Assistant Examiner—Carmen H. Vales
Attorney, Agent, or Firm—Wenderoth, Lind & Ponack

[57] CLAIM

The ornamental design for a sewing machine, substantially as shown and described.

DESCRIPTION

FIG. 1 is a front elevational view of a sewing machine showing my new design;
FIG. 2 is a rear elevational view thereof;
FIG. 3 is a left side elevational view thereof;
FIG. 4 is a right side elevational view thereof;
FIG. 5 is a top plan view thereof;
FIG. 6 is a bottom plan view thereof; and
FIG. 7 is a perspective view thereof.

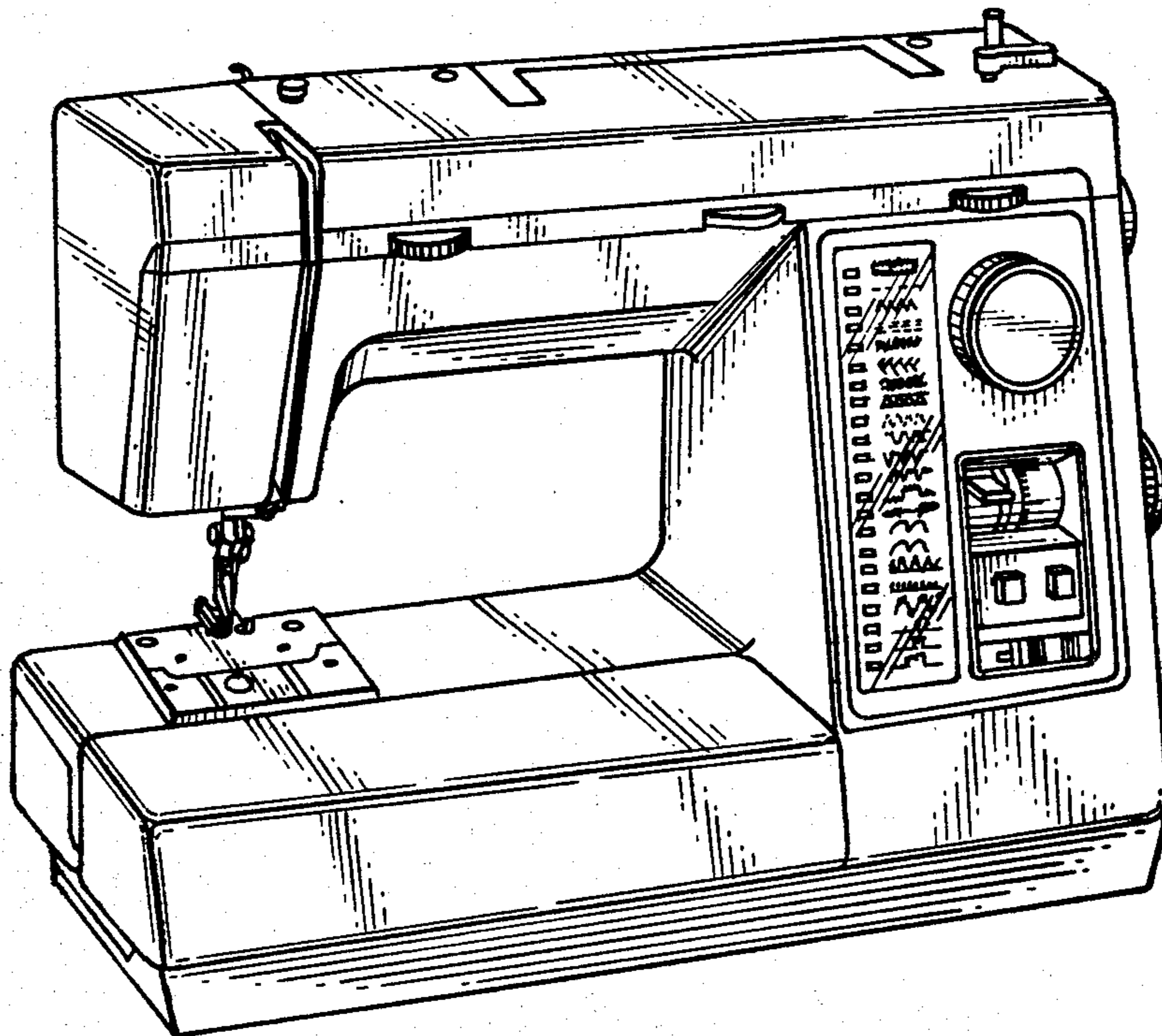

FIG. 1.

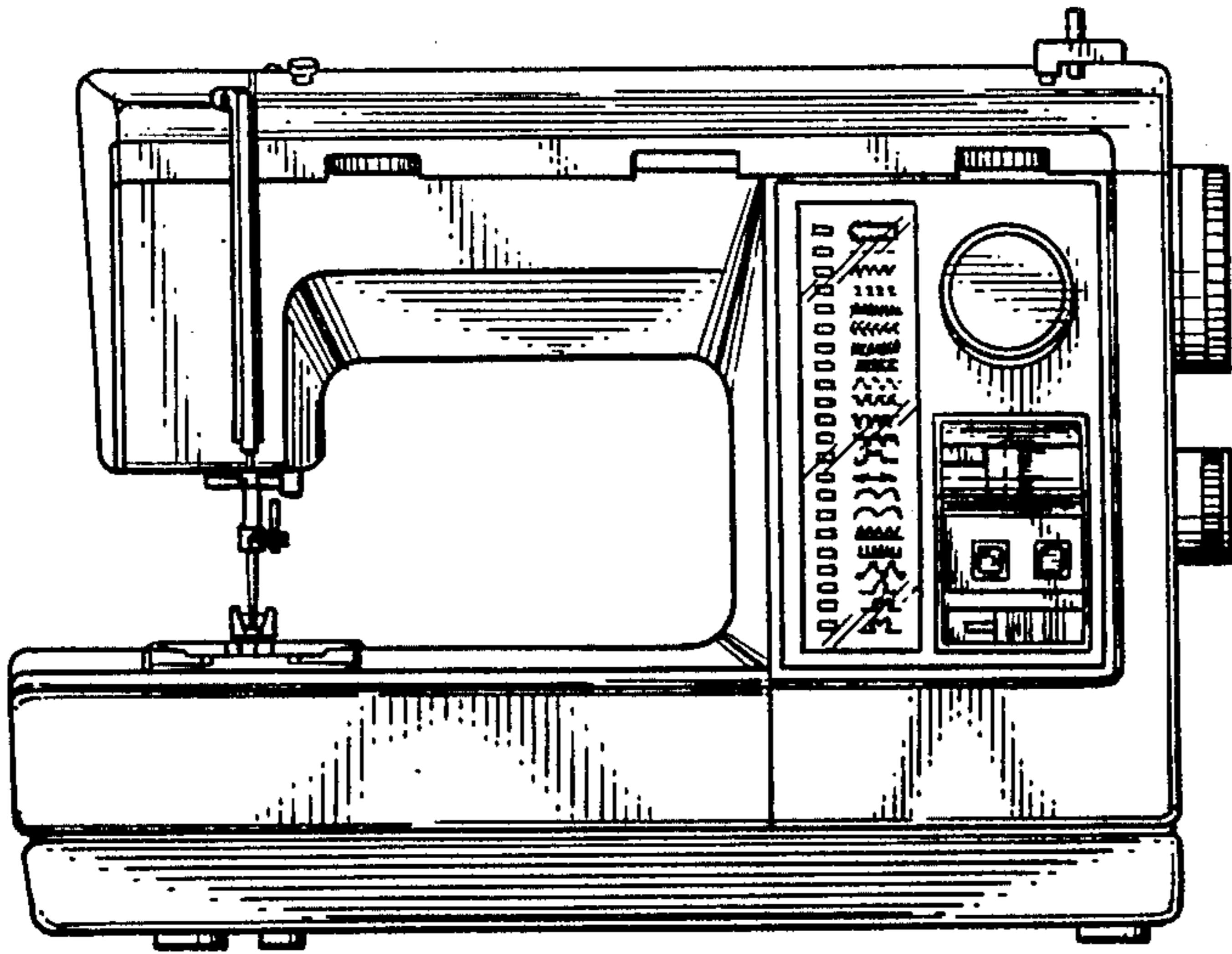

FIG. 3.

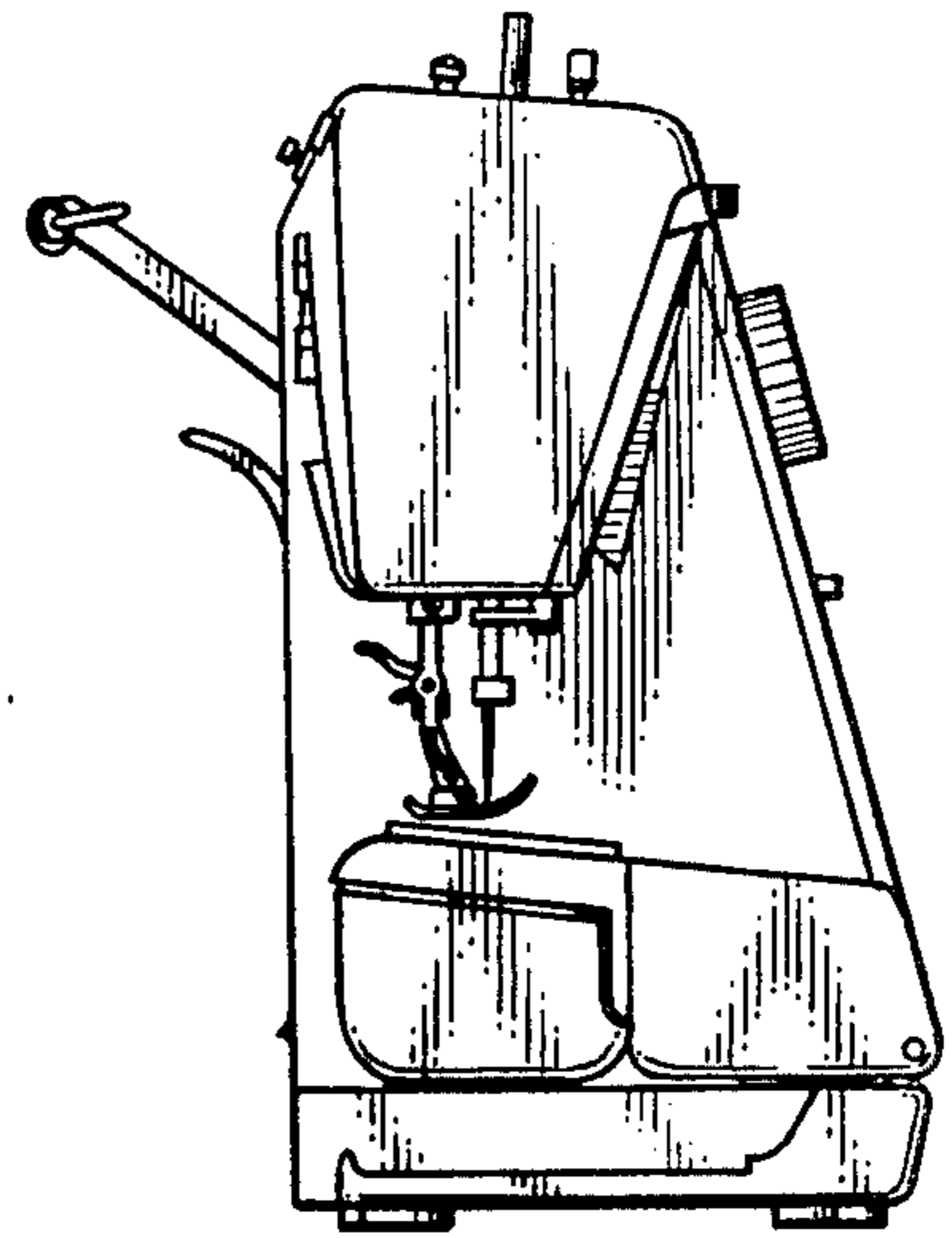

FIG. 2.

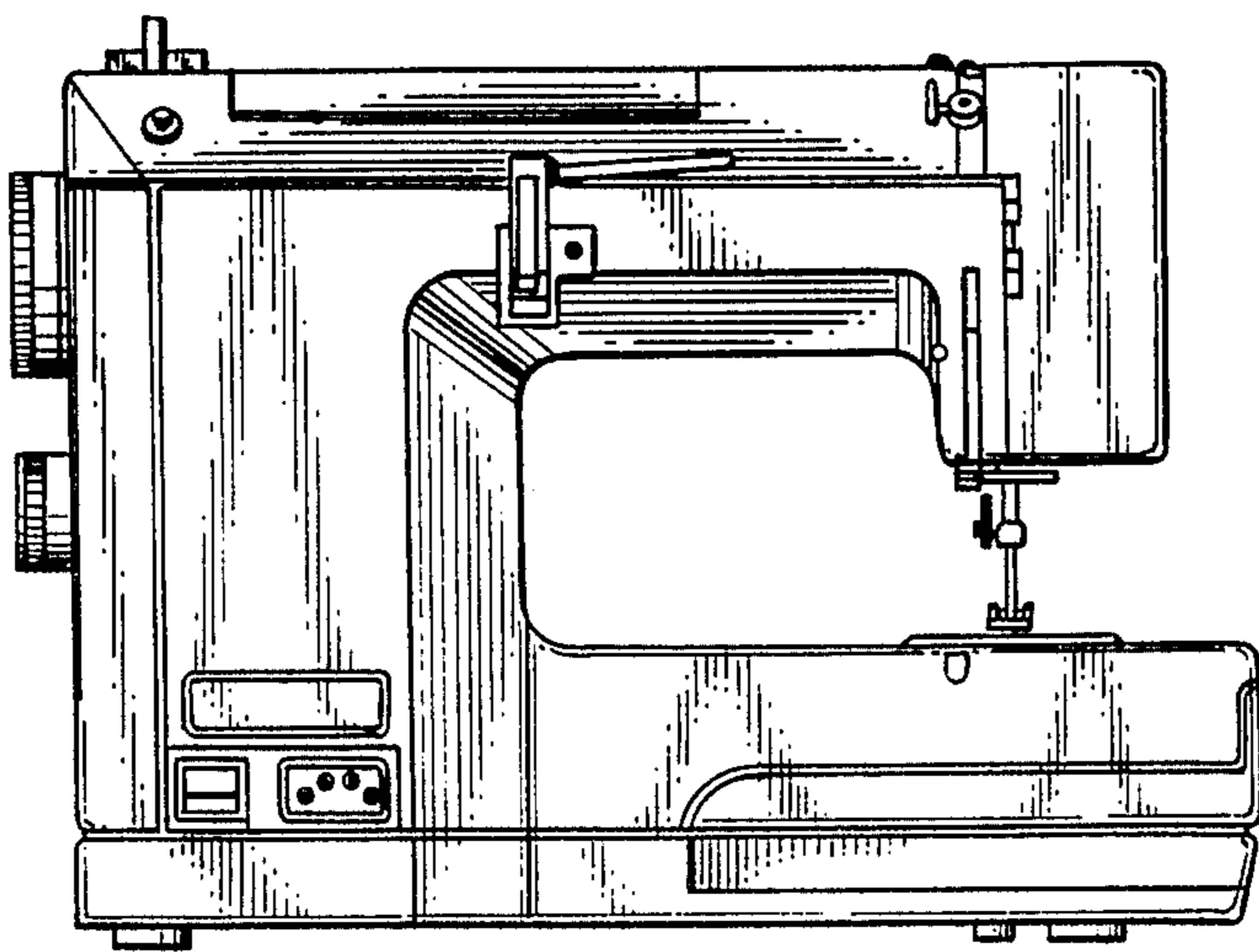

FIG. 4.

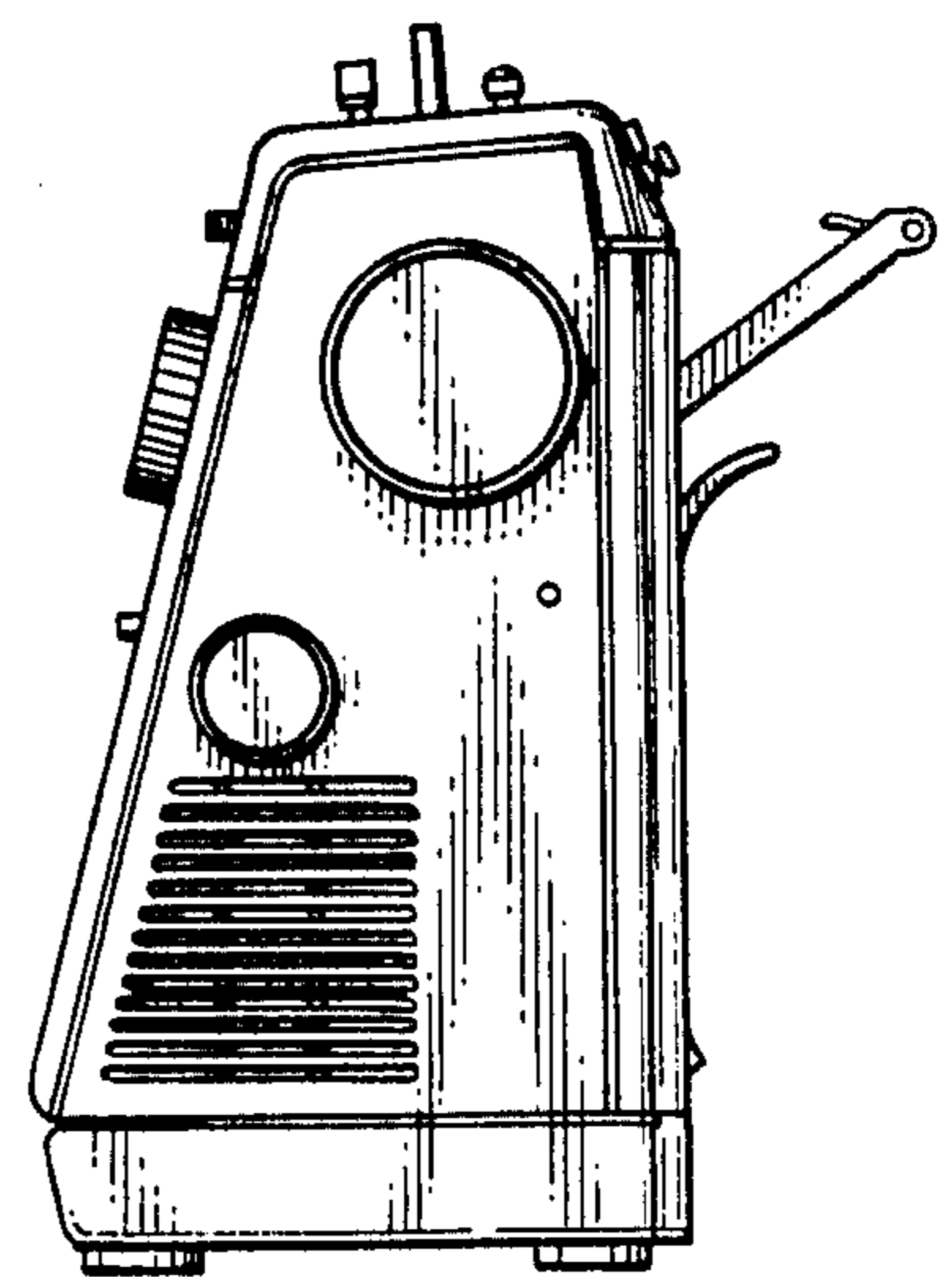

FIG. 5.

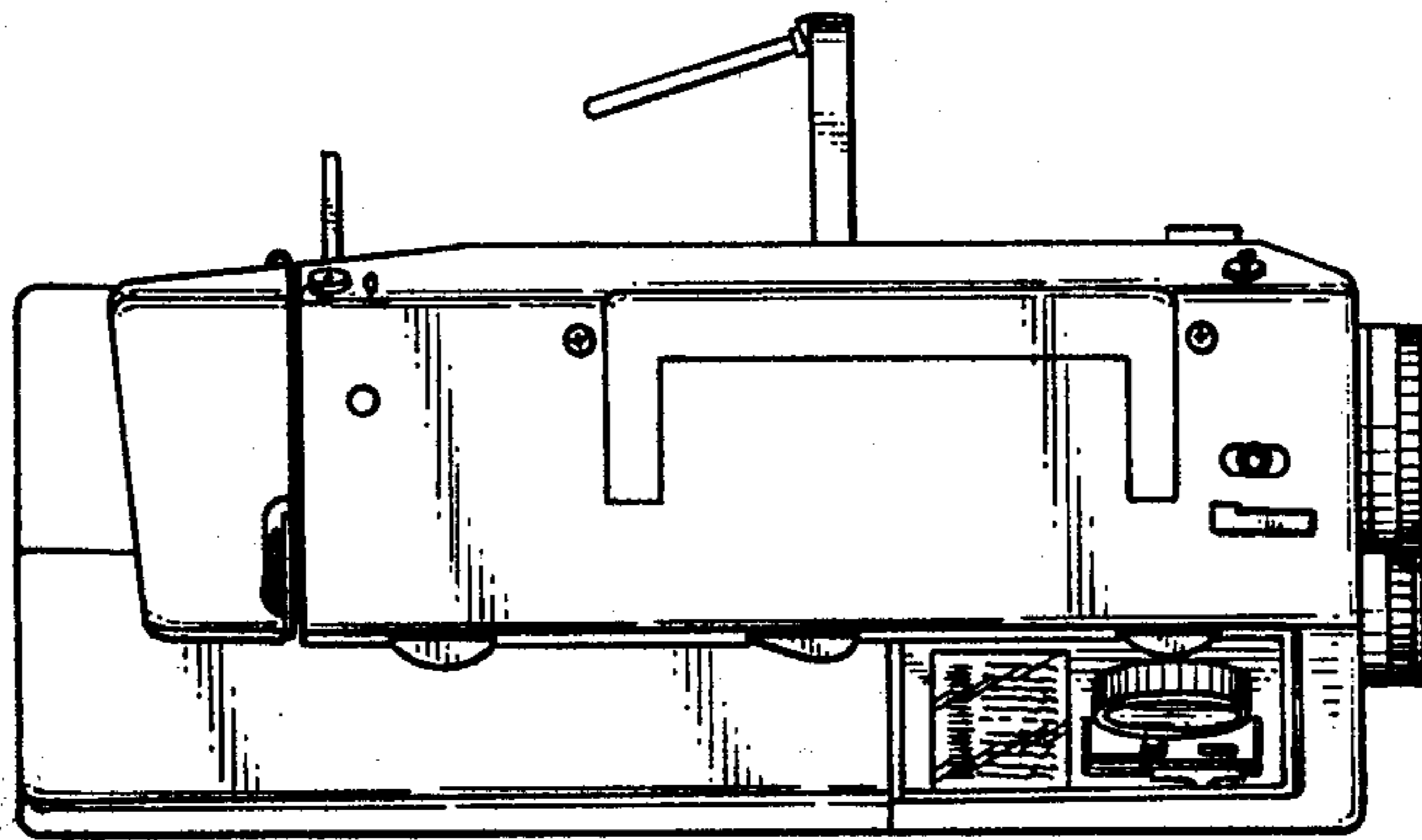

FIG. 6.

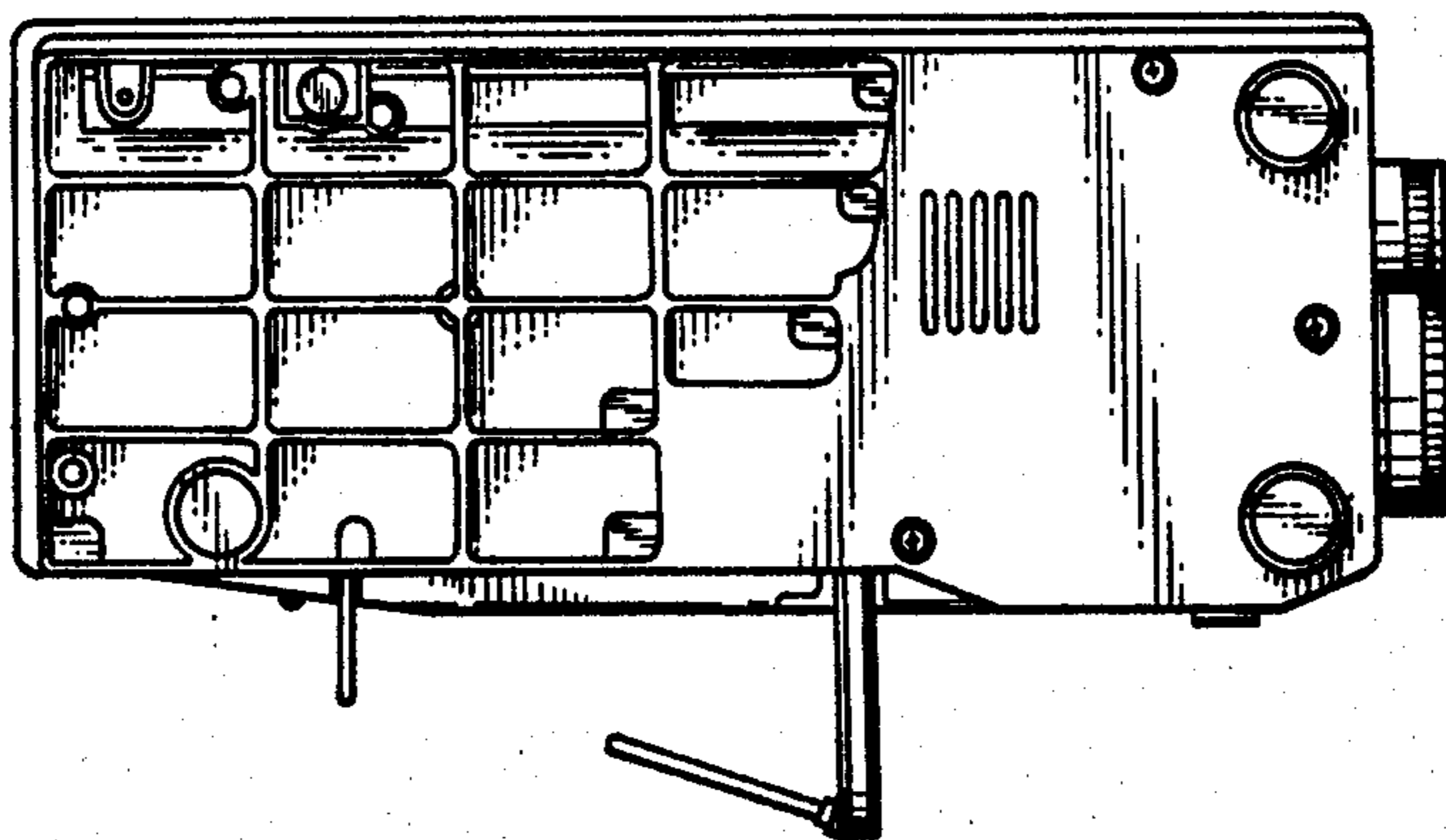

FIG. 7.

