

# United States Patent [19]

Nakamura

[11] Patent Number: **Des. 276,227**

[45] Date of Patent: **\*\* Nov. 6, 1984**

[54] **LOUDSPEAKER**

[75] Inventor: **Hitoshi Nakamura, Tokyo, Japan**

[73] Assignee: **Pioneer Electronic Corporation, Tokyo, Japan**

[\*\*] Term: **14 Years**

[21] Appl. No.: **379,193**

[22] Filed: **May 17, 1982**

[30] **Foreign Application Priority Data**

Jan. 22, 1982 [JP] Japan ..... 57-2236  
[52] U.S. Cl. .... D14/33; D14/34;  
D14/39

[58] Field of Search ..... D14/30, 32-34,  
D14/37, 39

[56] **References Cited**

**U.S. PATENT DOCUMENTS**

D. 132,743 6/1942 O'Neil ..... D14/32

D. 227,904 7/1973 Takeoka et al. .... D14/33  
D. 229,066 11/1973 Ekdahl et al. .... D14/33  
D. 247,236 2/1978 Croup ..... D14/33  
D. 247,489 3/1978 Jabara ..... D14/33

*Primary Examiner*—Jane E. Corrigan  
*Attorney, Agent, or Firm*—Sughrue, Mion, Zinn,  
Macpeak & Seas

[57] **CLAIM**

The ornamental design for a loudspeaker, as shown.

**DESCRIPTION**

FIG. 1 is a front elevational view of a loudspeaker showing my new design;  
FIG. 2 is a rear elevational view thereof;  
FIG. 3 is a top plan view thereof;  
FIG. 4 is a bottom plan view thereof;  
FIG. 5 is a left side elevational view thereof;  
FIG. 6 is a right side elevational view thereof; and  
FIG. 7 is a front, top and right side perspective view thereof.

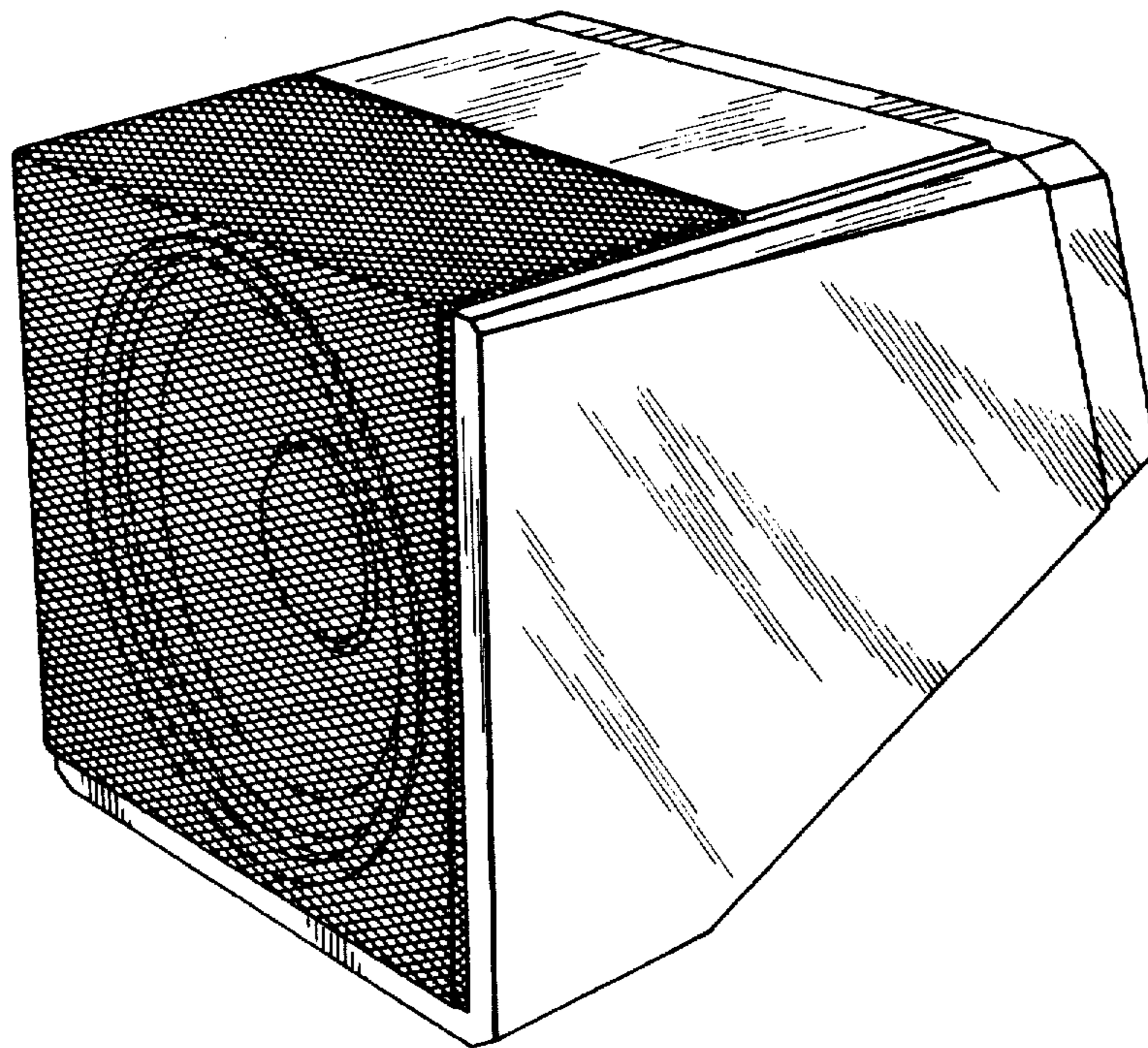

FIG. 1

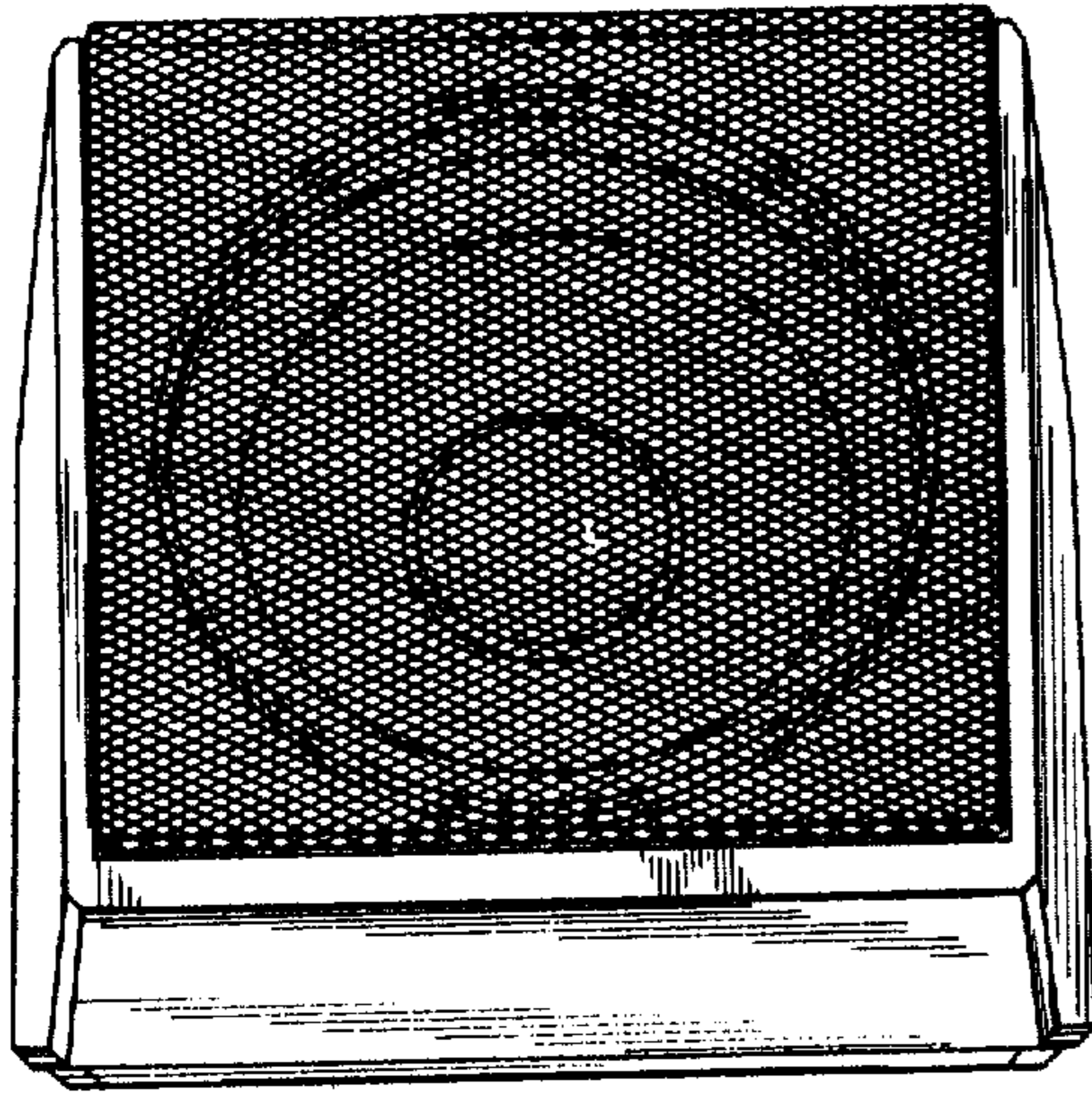

FIG. 2

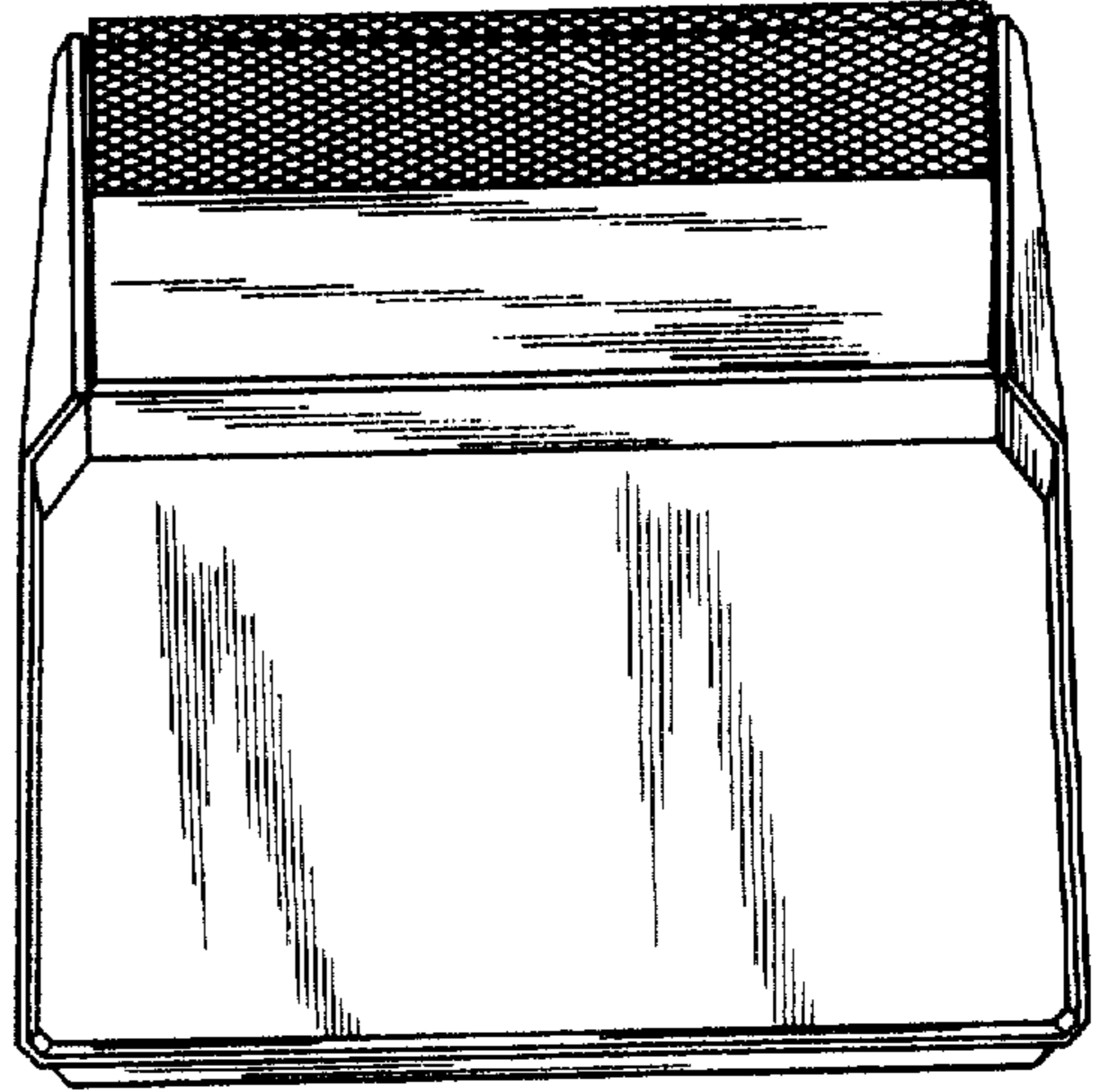

FIG. 3

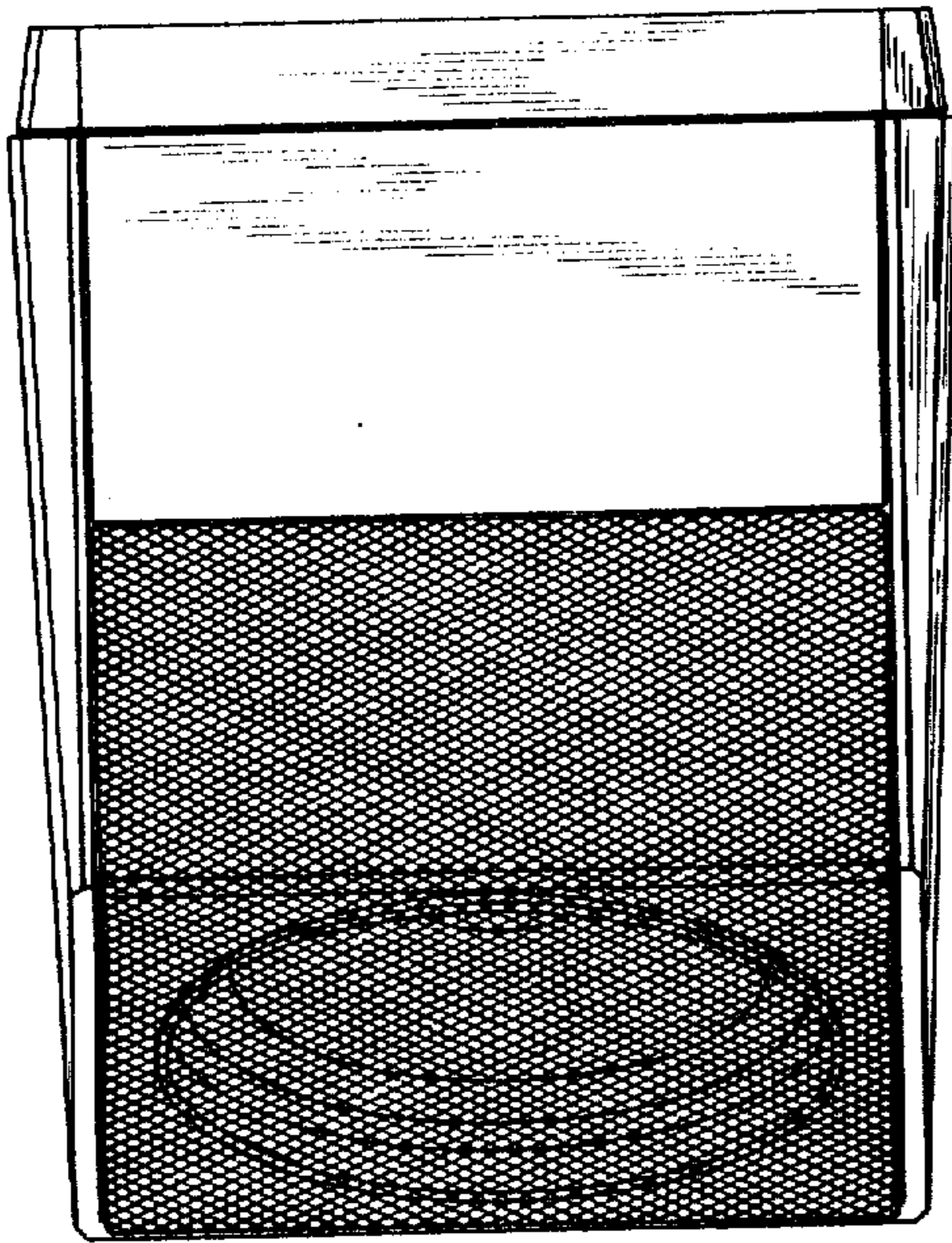

FIG. 4

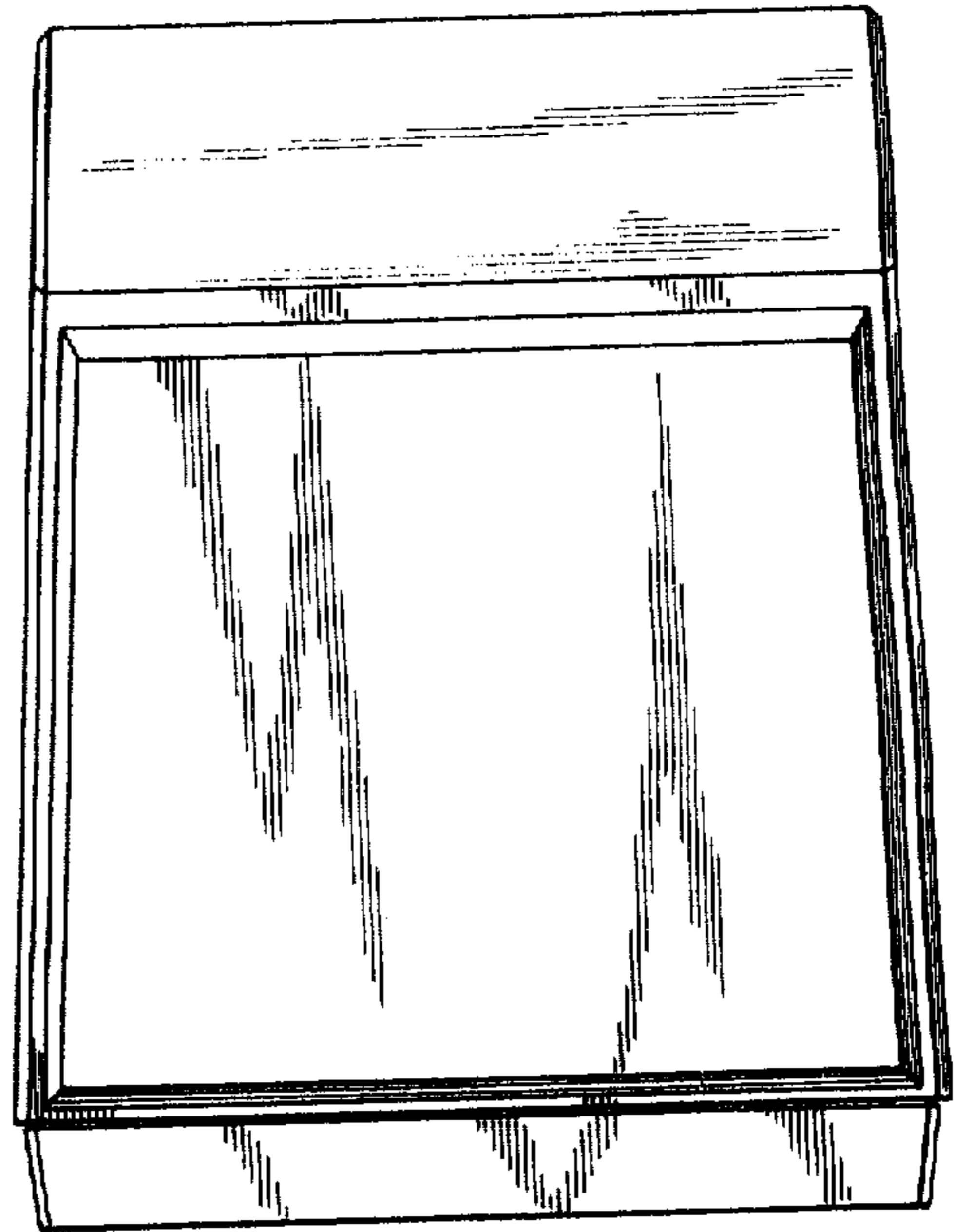

FIG. 5

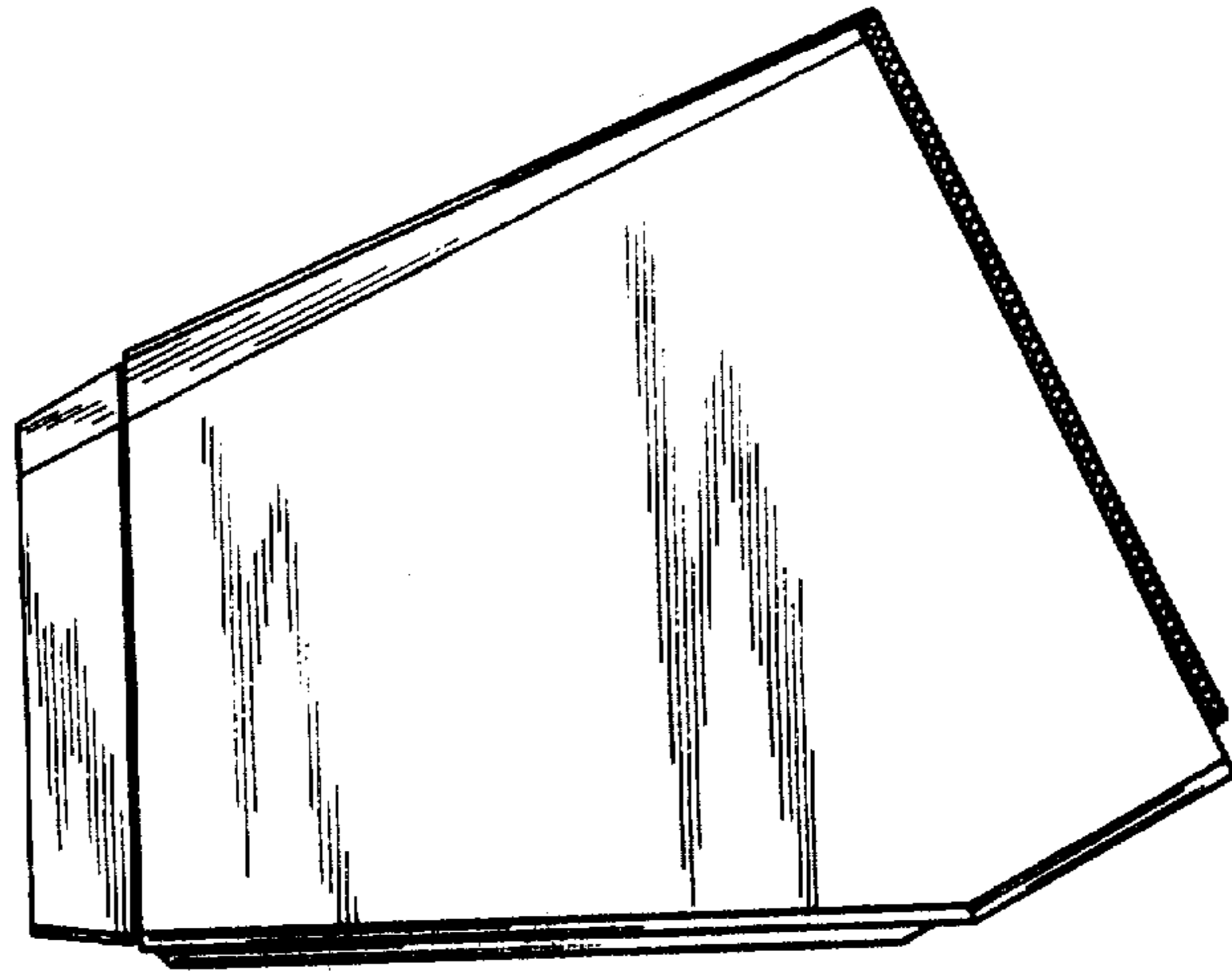

FIG. 6

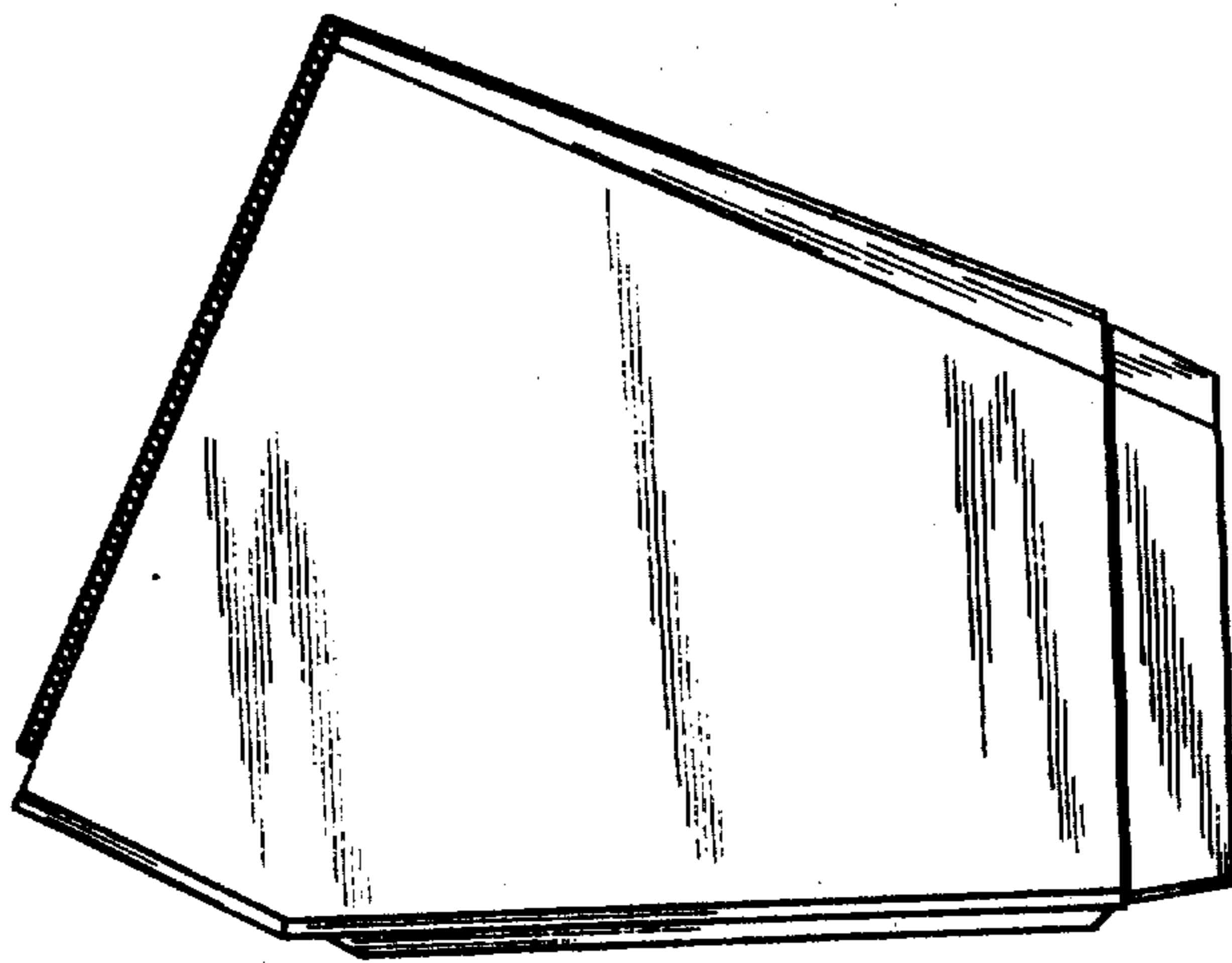

FIG. 7

