

[54] PEPPER MILL

[76] Inventor: Kenneth M. Ferrin, 66 Newtown La., East Hampton, N.Y. 11937

[**] Term: 14 Years

[21] Appl. No.: 395,688

[22] Filed: Jul. 6, 1982

[52] U.S. Cl. D7/53; D7/372

[58] Field of Search D7/52, 53, 54, 55, 57, D7/372, 373; 241/169, 169.1; 222/142.1-142.9

[56] References Cited

U.S. PATENT DOCUMENTS

| | | | | |
|------------|---------|------------------|-------|-------------|
| D. 108,942 | 3/1938 | Gravem | | D7/57 |
| D. 188,466 | 7/1960 | Silverman et al. | | D7/54 |
| D. 253,157 | 10/1979 | Dziekonski | | D7/372 |
| D. 262,975 | 2/1982 | Garriga | | D7/53 X |
| 1,289,440 | 12/1918 | Goldsmith | | 222/142.4 |
| 1,535,772 | 4/1925 | Haufler | | 241/169.1 X |
| 1,575,506 | 3/1926 | Rogers | | 222/142.3 |

OTHER PUBLICATIONS

The Gift & Art Buyer, Oct. 1960, p. 100, bottom of page, middle left Salt Mill/Turn Key Handle, Europa Comm, Inc.

Primary Examiner—Winifred E. Herrmann
Attorney, Agent, or Firm—Guy W. Shoup

[57] CLAIM

The ornamental design for a pepper mill, substantially as shown.

DESCRIPTION

FIG. 1 is a top, front and left side perspective view of a pepper mill showing my new design; FIG. 2 is a top plan view thereof; FIG. 3 is a front elevational view thereof; FIG. 4 is a left side elevational view thereof; FIG. 5 is a right side elevational view thereof; FIG. 6 is a rear elevational view thereof; and FIG. 7 is a bottom plan view thereof.

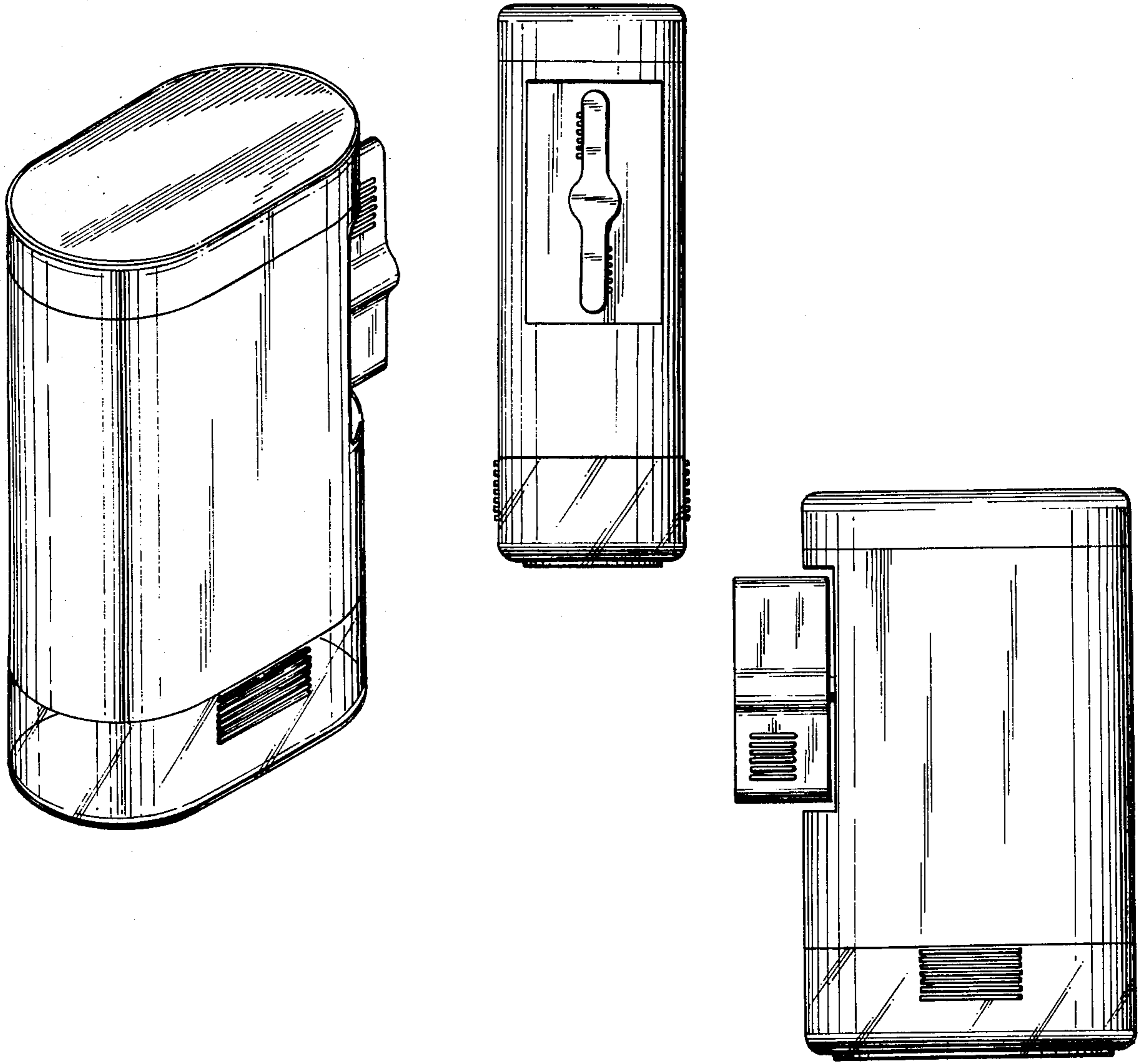

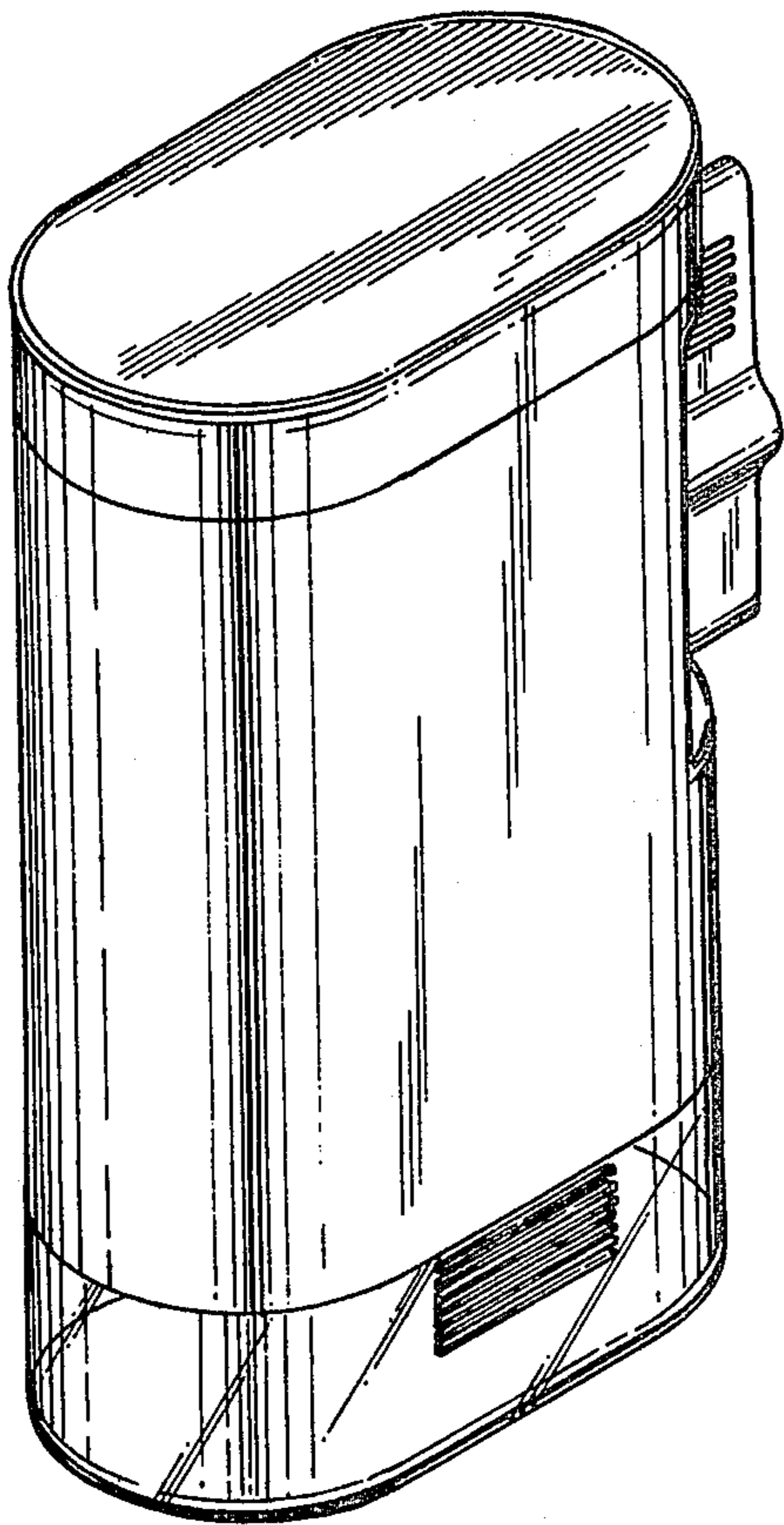

FIG. 1

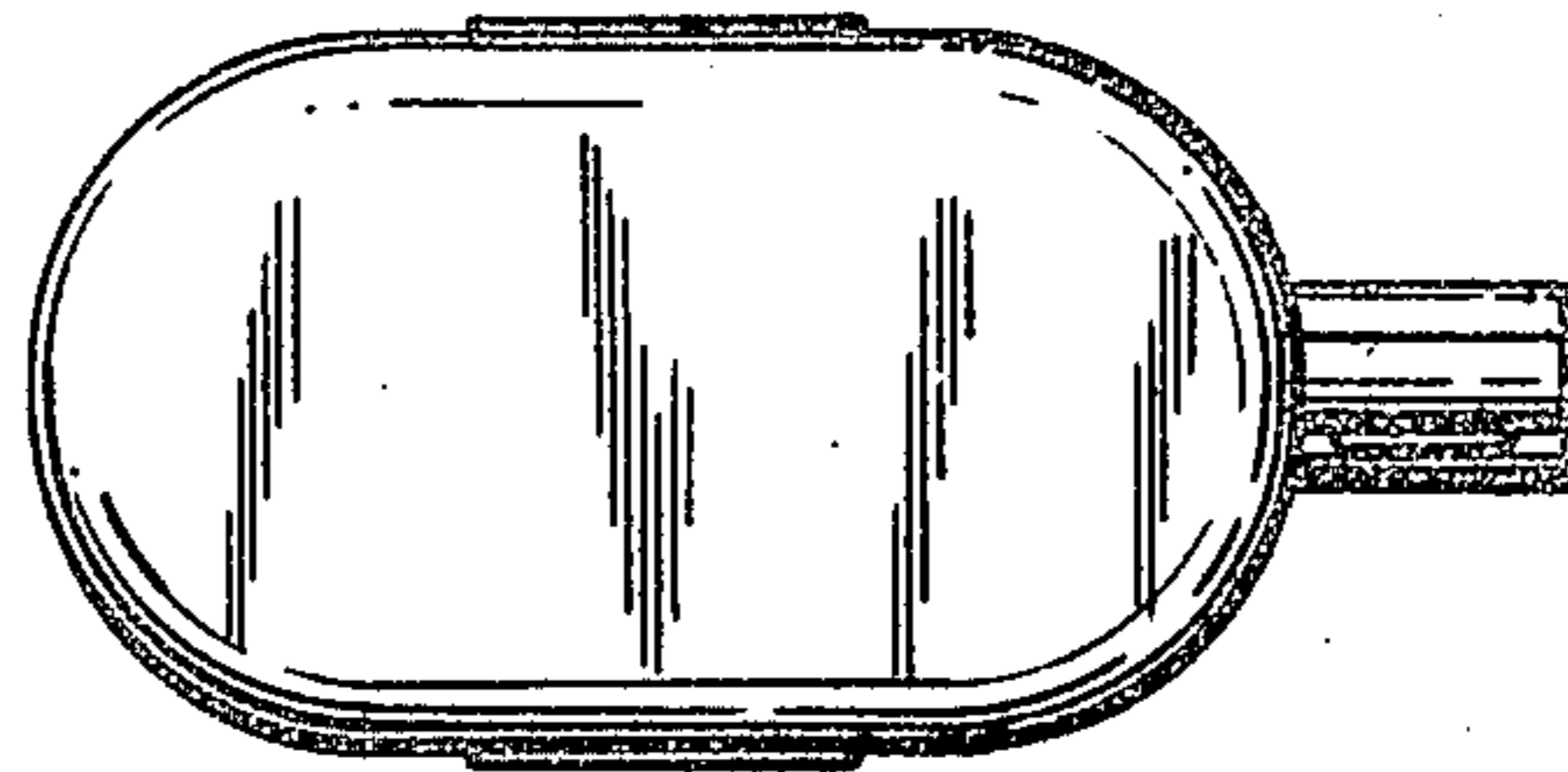

FIG. 2

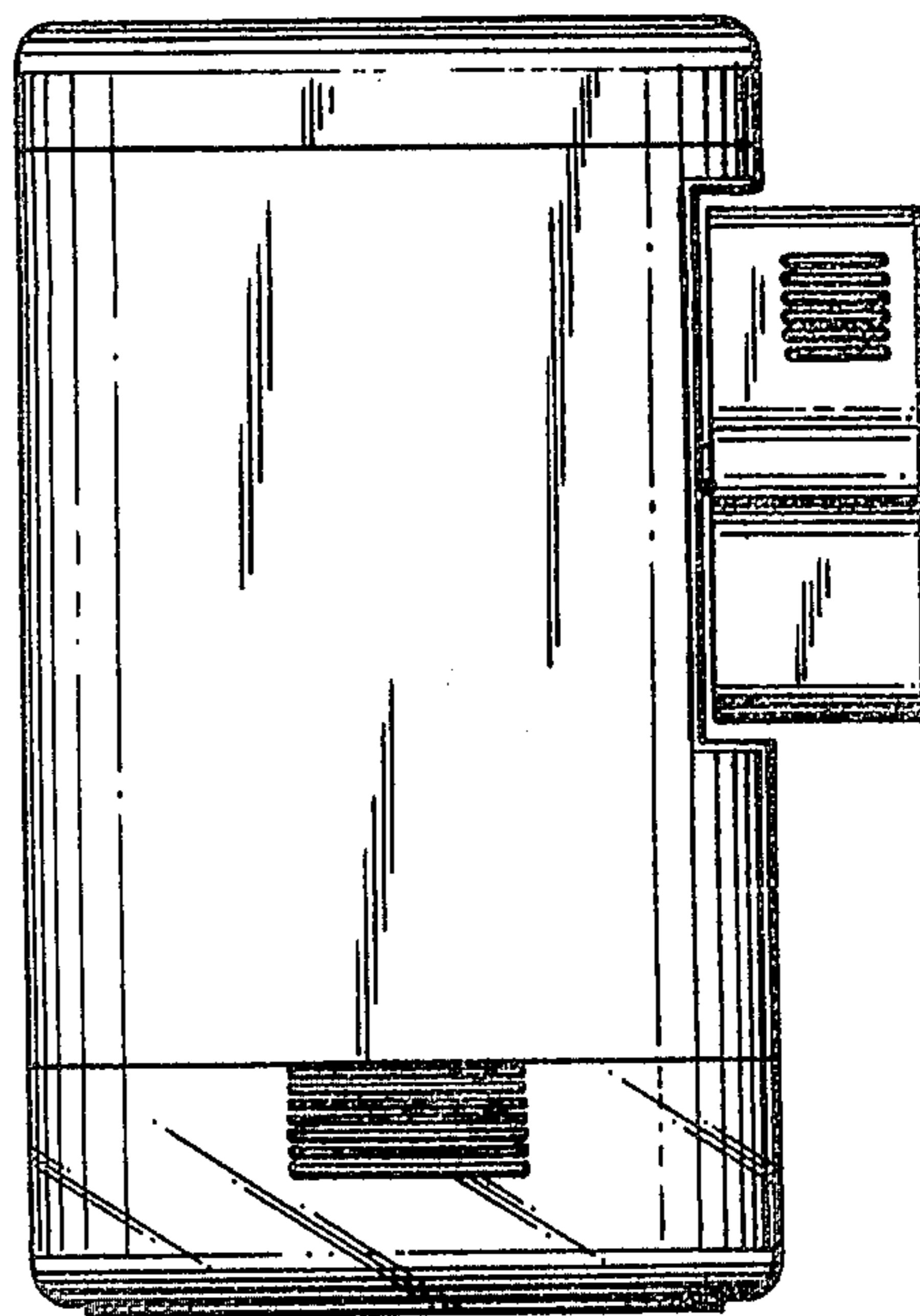

FIG. 3

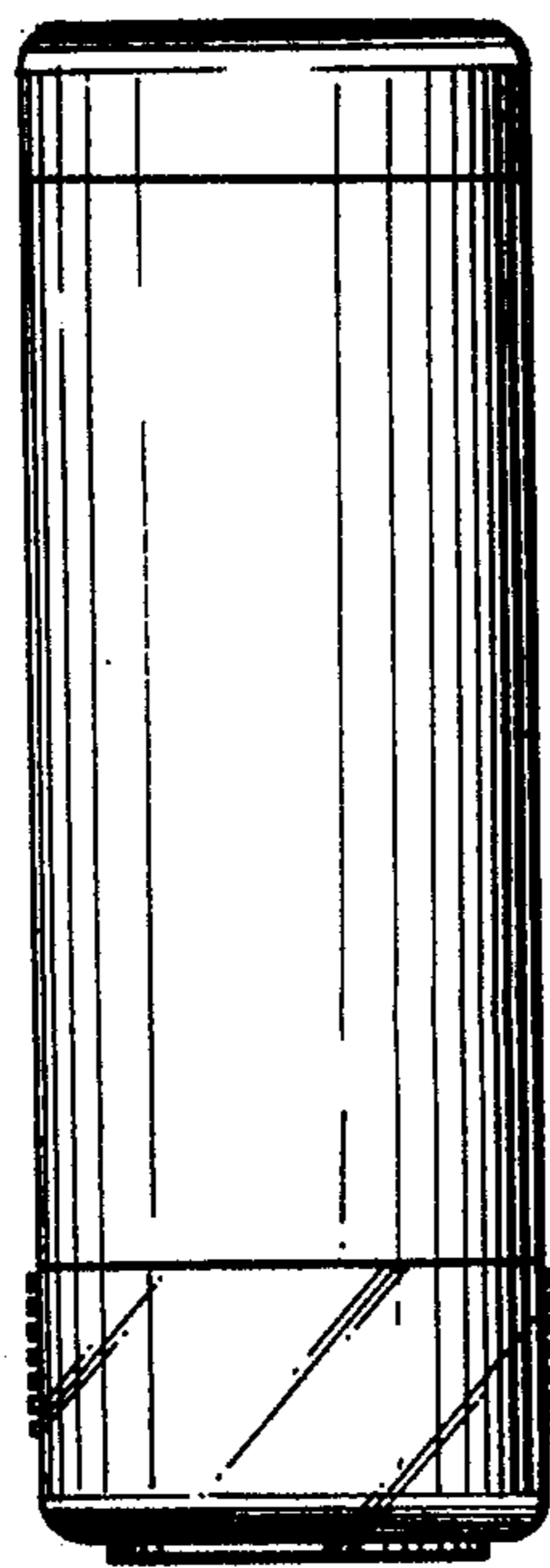

FIG. 4

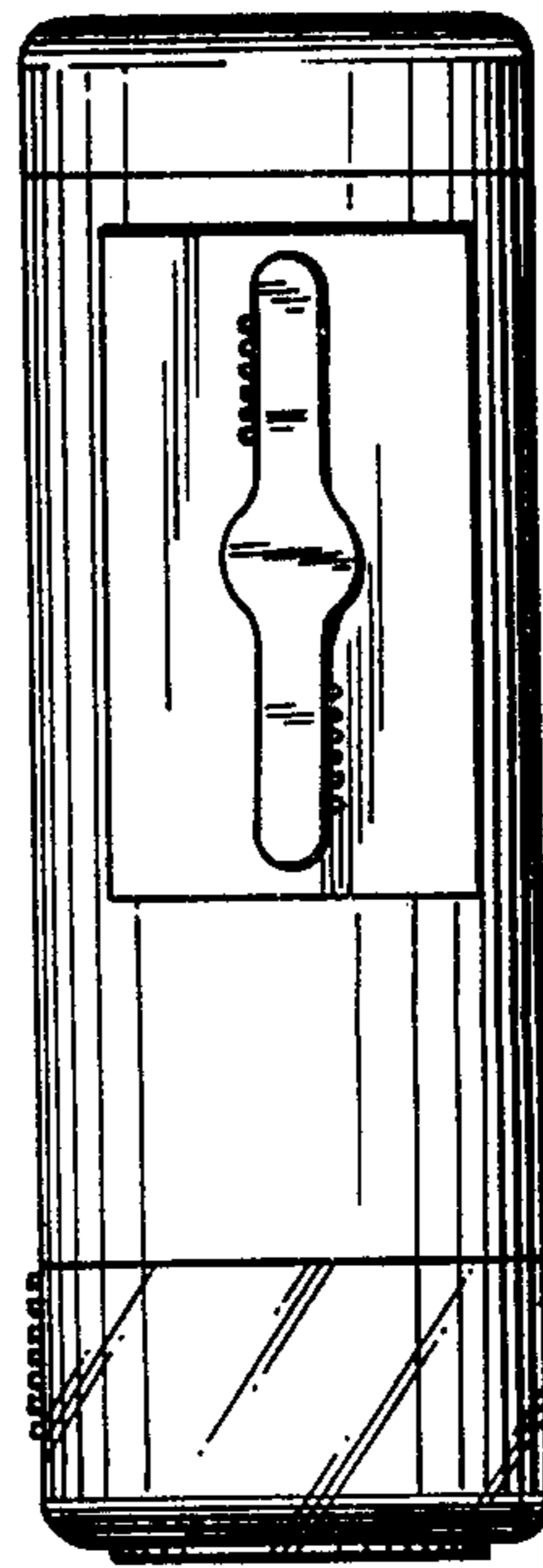

FIG. 5

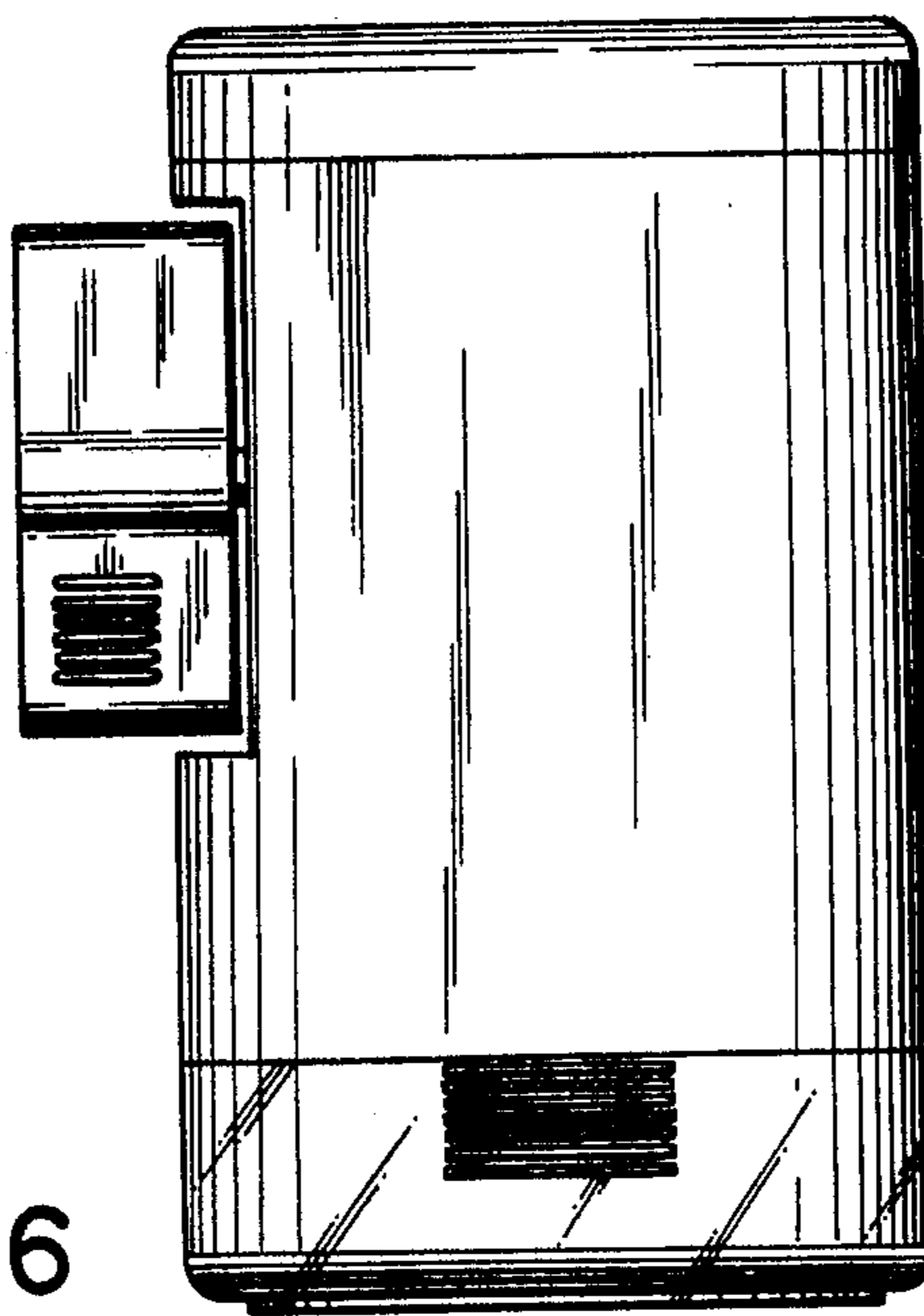

FIG. 6

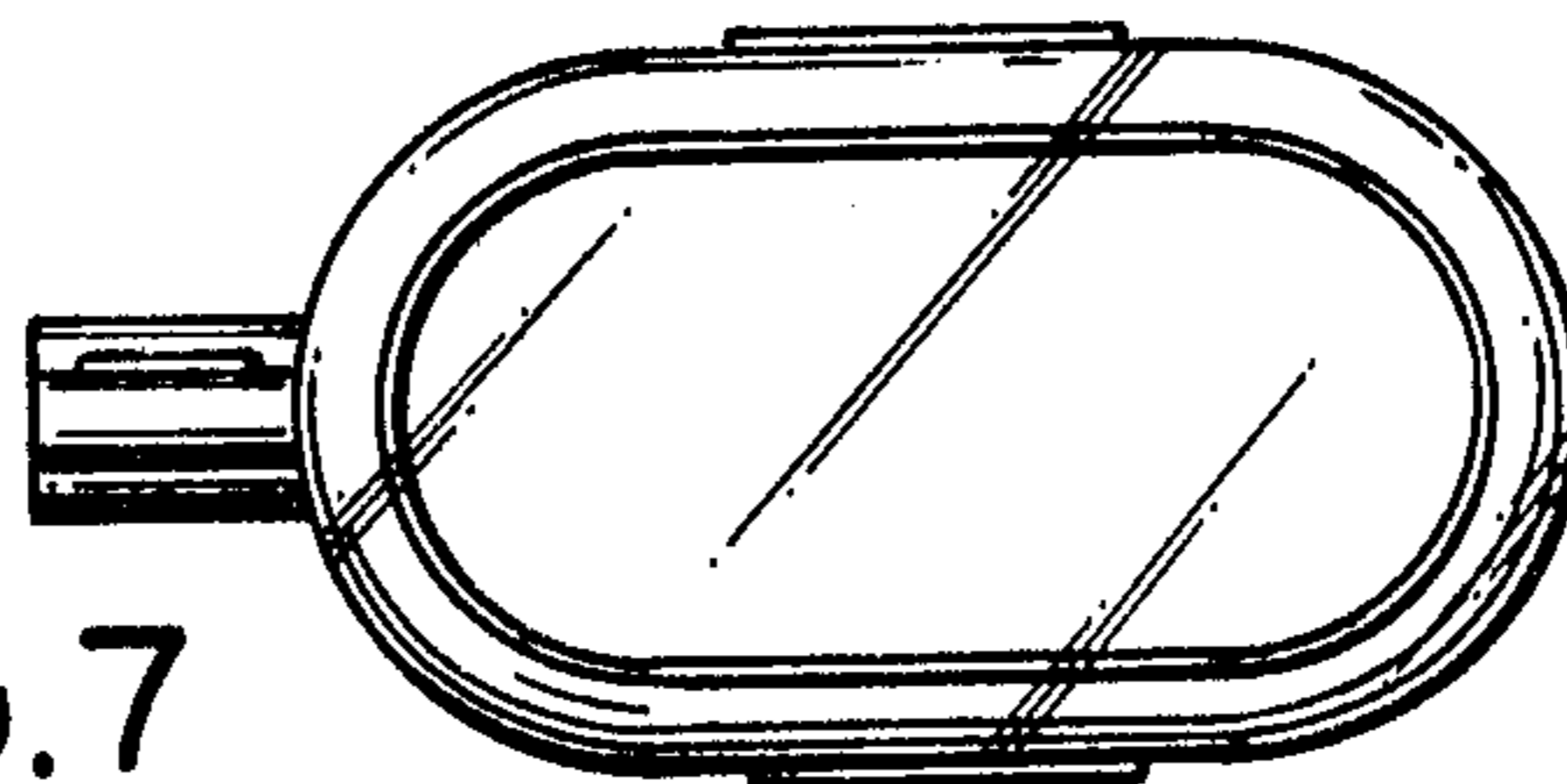

FIG. 7