

United States Patent [19]

Boldt, deceased et al.

[11] **Patent Number: Des. 275,952**

[45] **Date of Patent: ** Oct. 16, 1984**

[54] **TELEVISION RECEIVER CABINET**

[75] **Inventors:** Melvin H. Boldt, deceased, late of Glenview, Ill.; by Melvin W. Boldt, executor, Palatine, Ill.; David P. Chuboff, North Barrington, Ill.; Wayne J. Franek, Palatine, Ill.

[73] **Assignee:** Zenith Radio Corporation, Glenview, Ill.

[**] **Term:** 14 Years

[21] **Appl. No.:** 353,277

[22] **Filed:** Mar. 1, 1982

[52] **U.S. Cl.** D14/82; D14/33

[58] **Field of Search** D14/77, 79-84, D14/33; 312/7.2

[56] **References Cited**

U.S. PATENT DOCUMENTS

D. 175,641 9/1955 Pifer D14/83

D. 256,920 9/1980 Takashima et al. D14/82 X
D. 265,650 8/1982 Sugiwaka et al. D14/82 X

FOREIGN PATENT DOCUMENTS

374056 12/1971 Japan D14/82

Primary Examiner—Jane E. Corrigan
Attorney, Agent, or Firm—Cornelius J. O'Connor

[57] **CLAIM**

The ornamental design for a television receiver cabinet, substantially as shown and described.

DESCRIPTION

FIG. 1 is a front, top and partial right side perspective view of a television receiver cabinet showing our new design;

FIG. 2 is a front elevational view;

FIG. 3 is a top plan view;

FIG. 4 is a left side elevational view;

FIG. 5 is a rear elevational view; and

FIG. 6 is a bottom plan view.

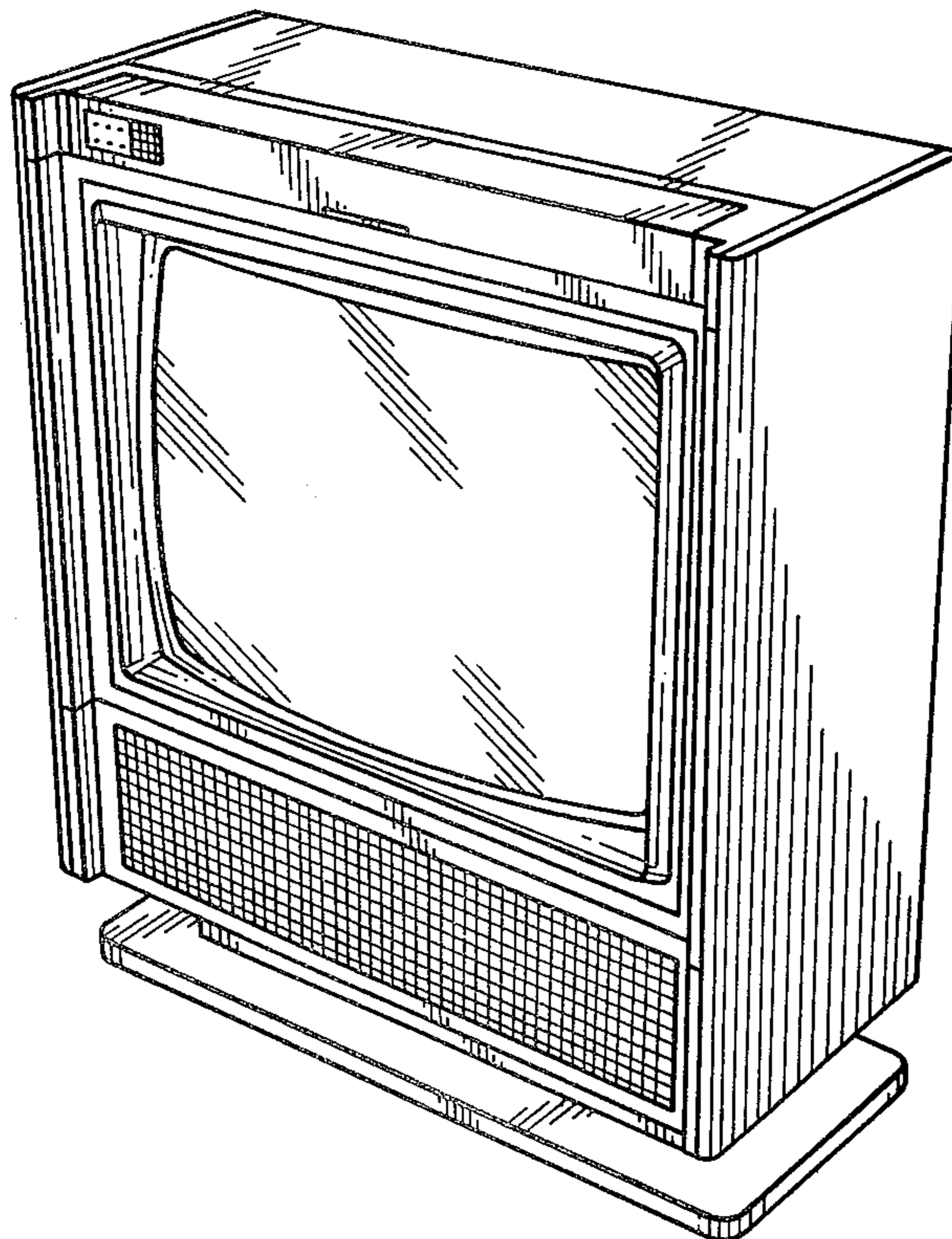

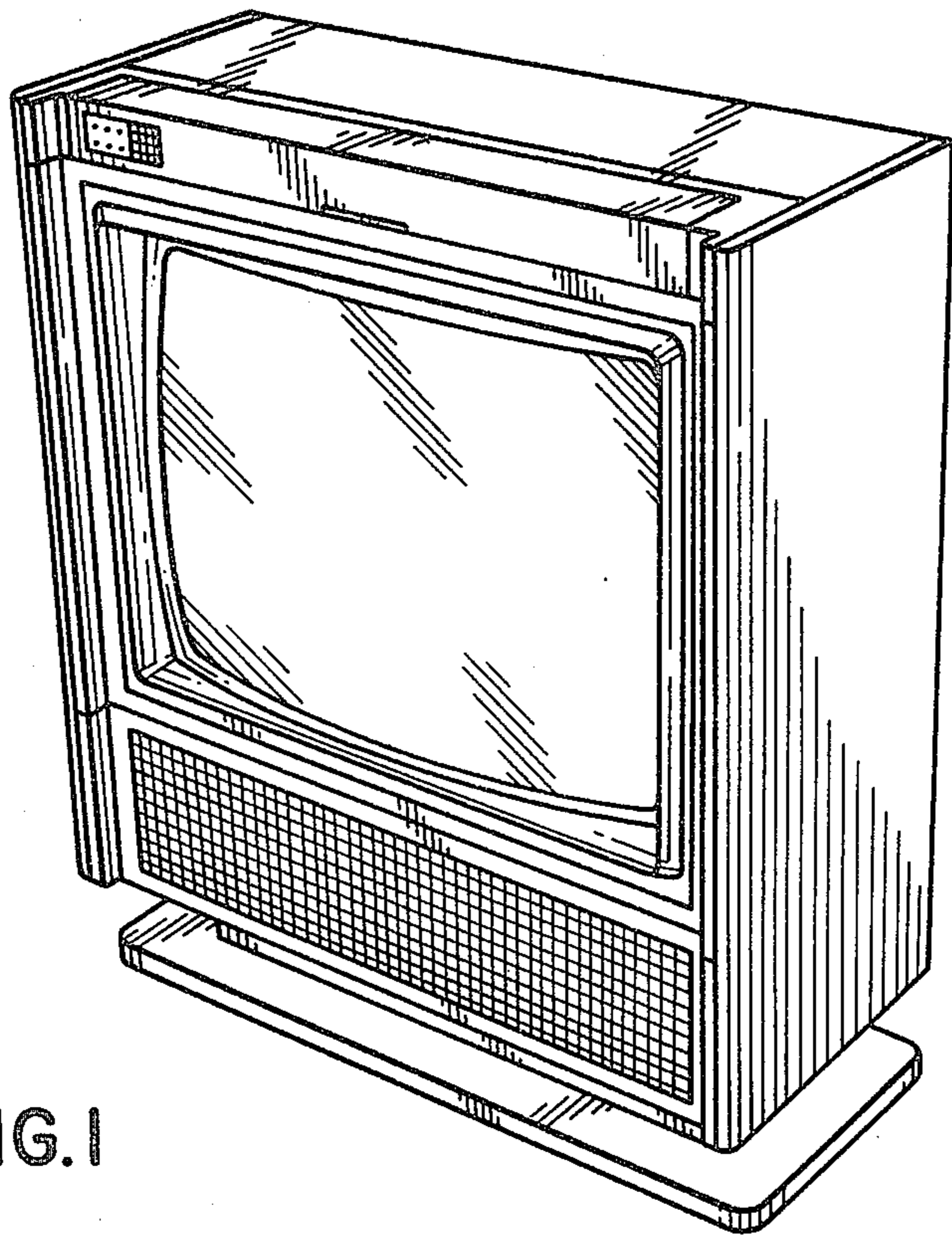

FIG. 1

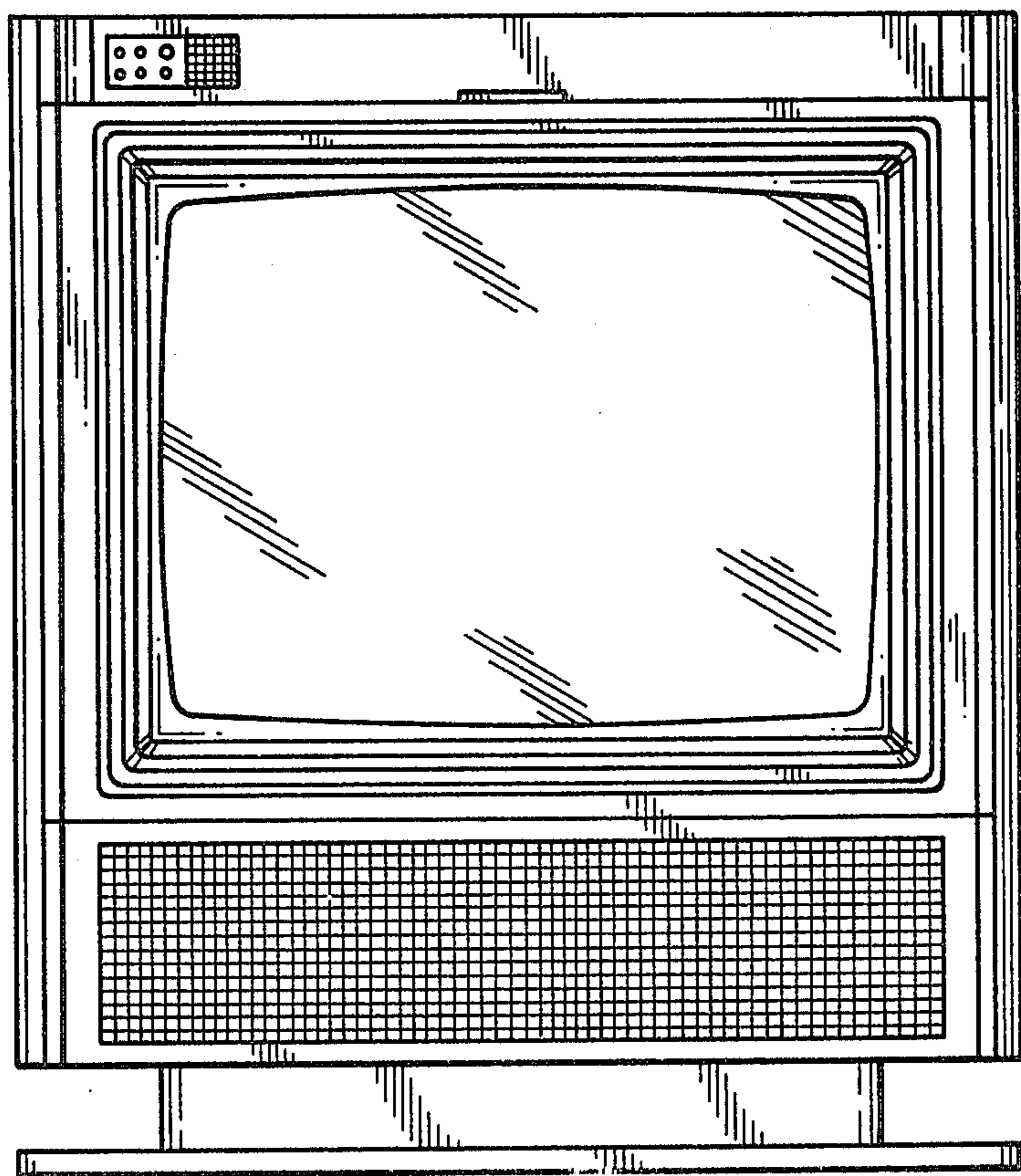

FIG. 2

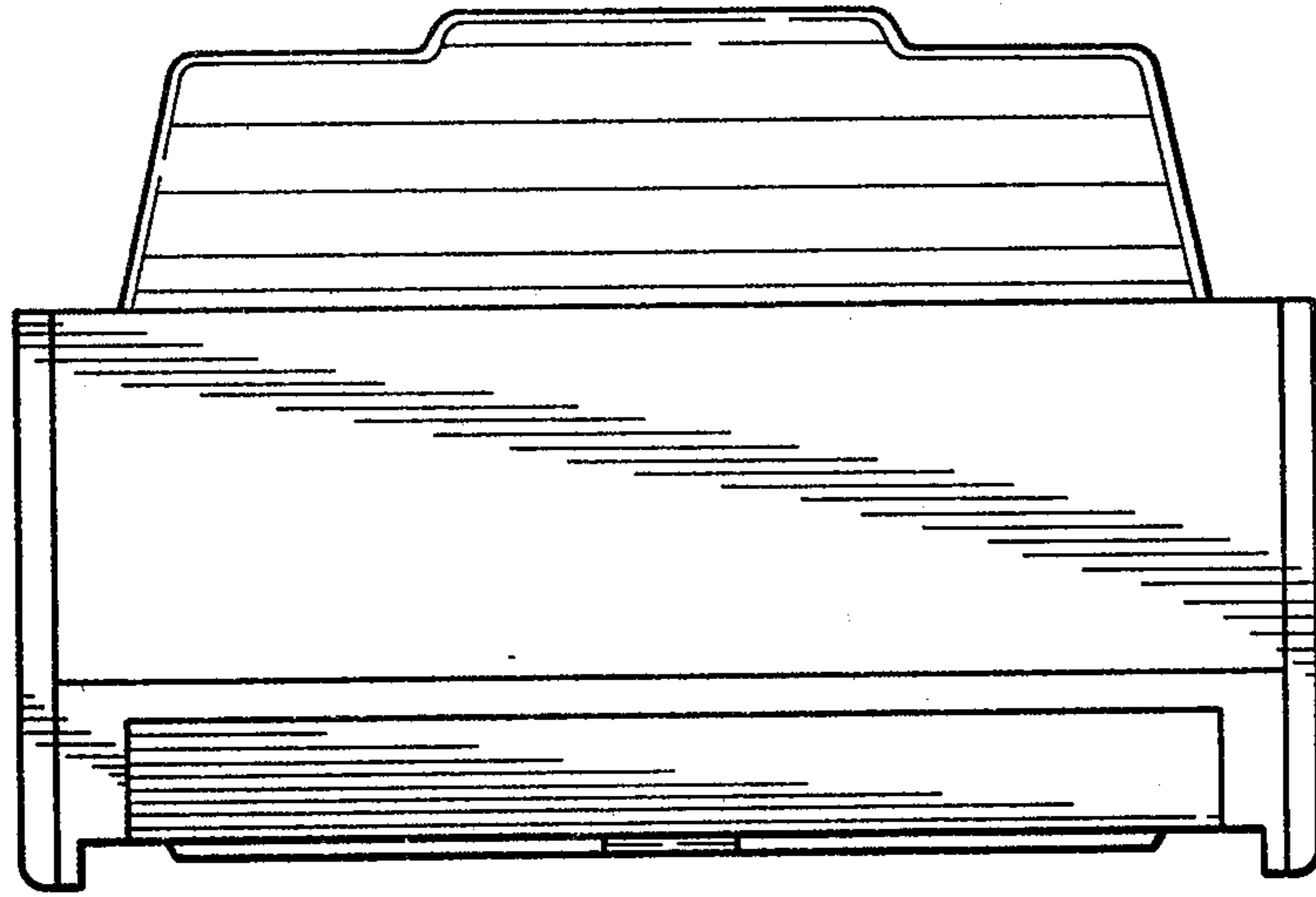

FIG. 3

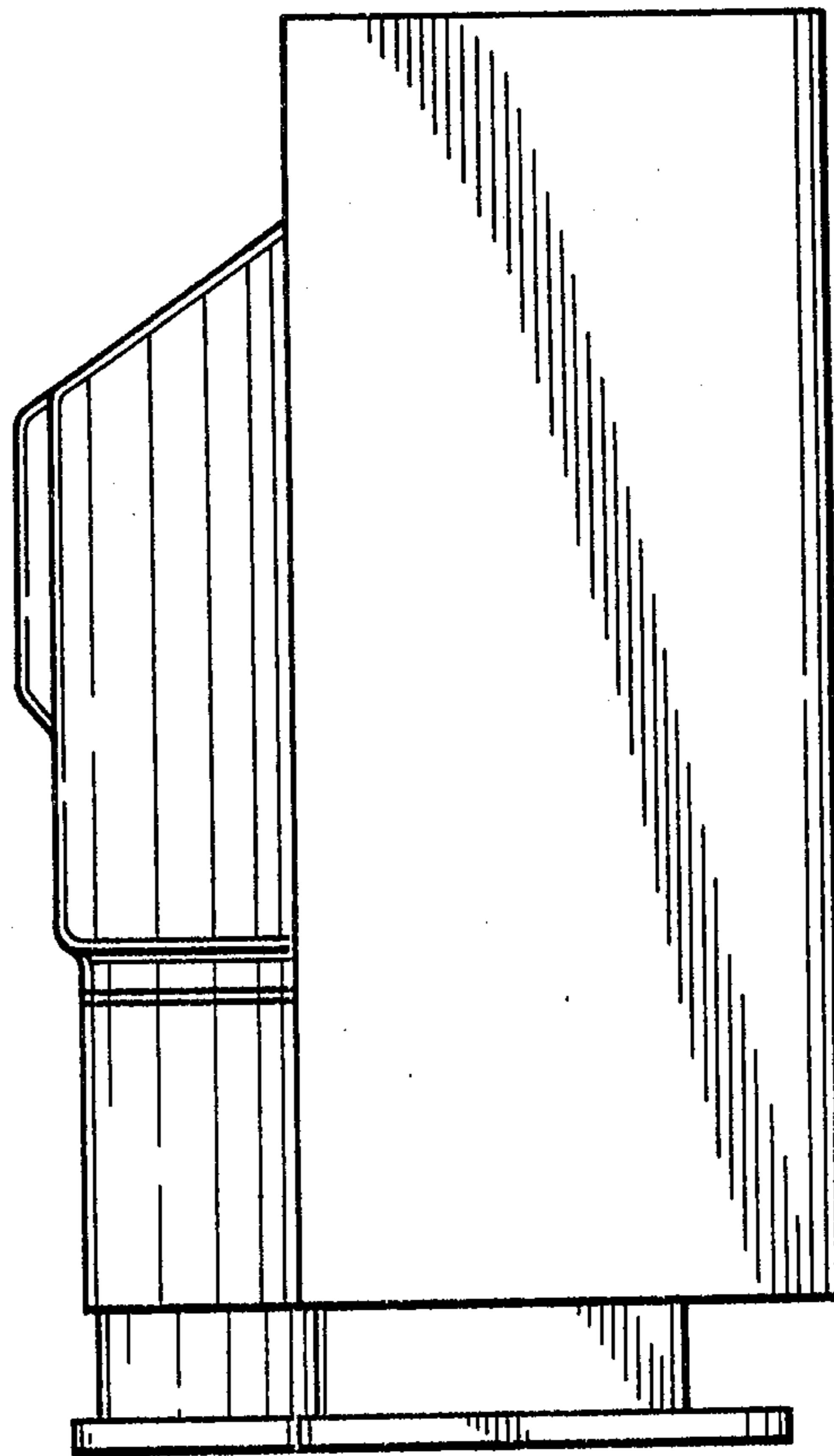

FIG. 4

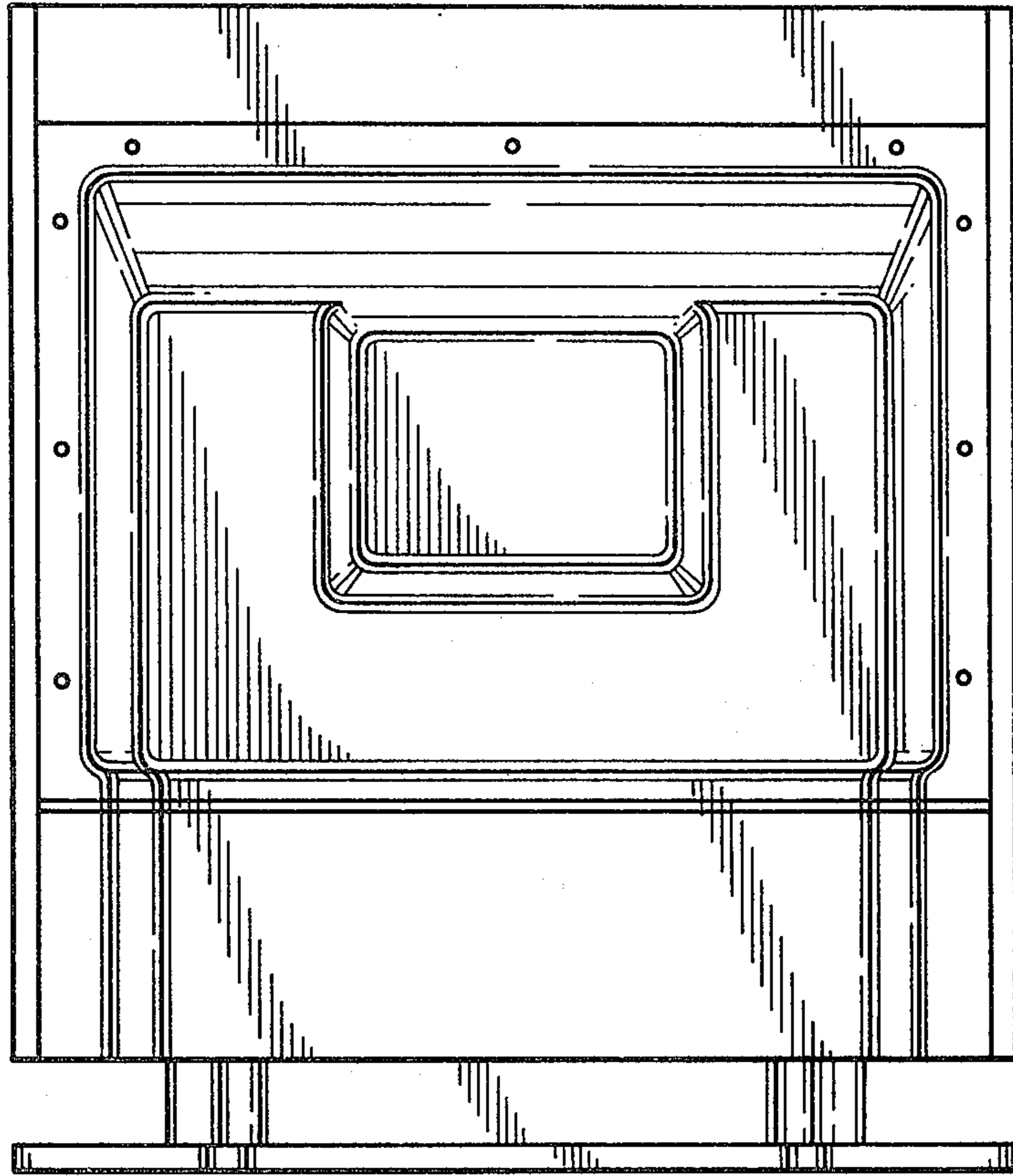

FIG. 5

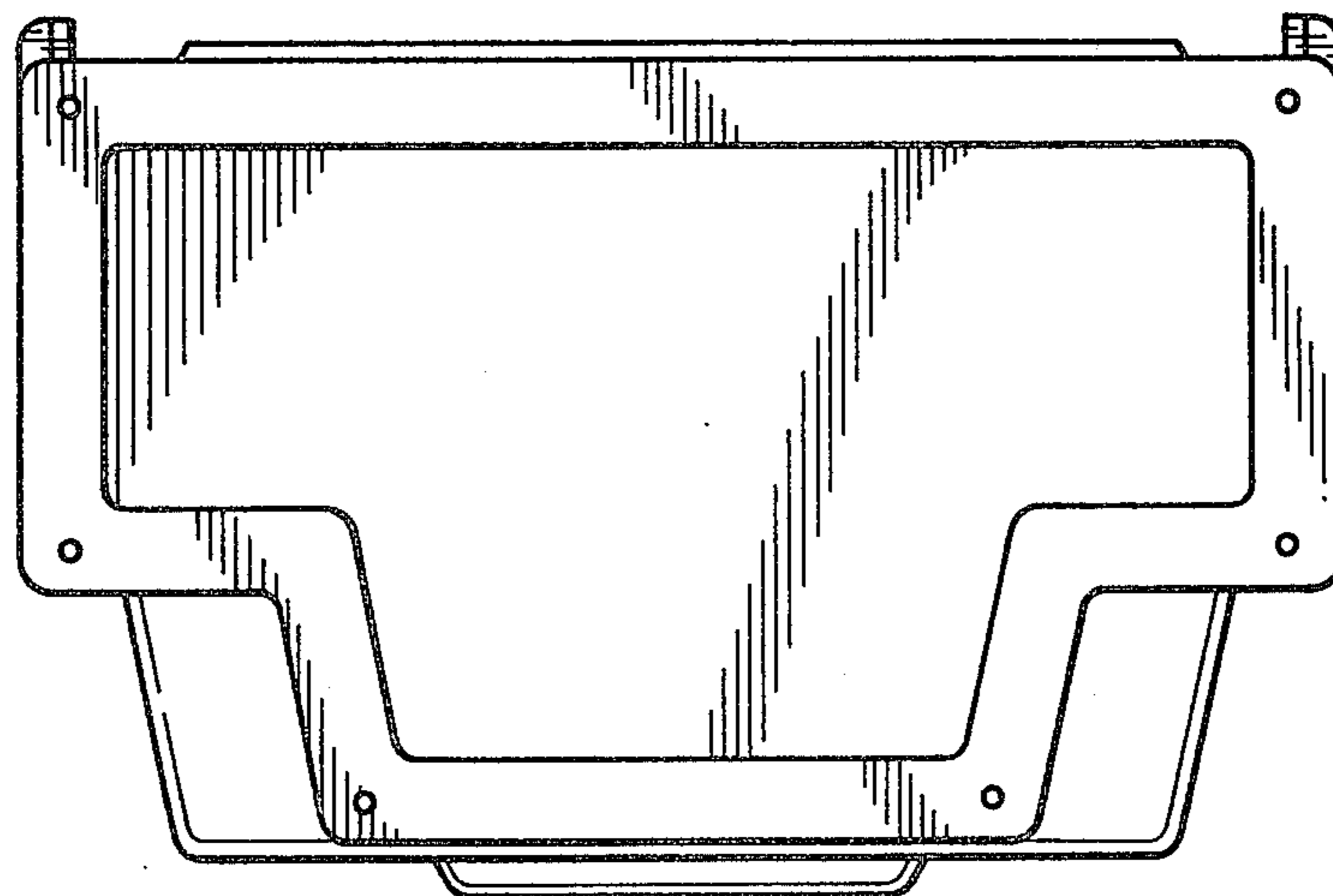

FIG. 6